



*Air source inverter heat pump for outdoor installation*

# ELFOEnergy STORM EVO

WSAN-YES 18.2 - 35.2 RANGE

TECHNICAL BULLETIN

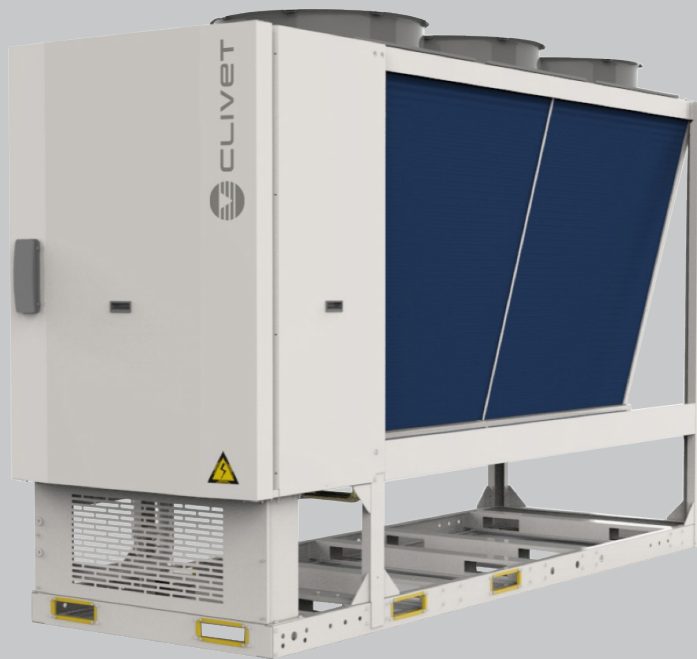

SIZE	18.2	20.1	25.2	30.2	35.2
COOLING CAPACITY KW	53,3	58,9	72,0	77,7	85,0
HEATING CAPACITY KW	53,0	66,0	79,3	84,7	91,0

---

## Page

3	Features and benefits
4	Standard unit technical specifications
5	Unit configuration
6	Built-in options
7	Options separately supplied
8	General technical data
26	Modularity
29	Dimensional drawings



Clivet is taking part in the EUROVENT certification programme. The products concerned appear in the certified products list of the EUROVENT [www.eurovent-certification.com](http://www.eurovent-certification.com) site.

# Features and benefits

ELFOEnergy Storm EVO series is the new air cooled heat pump, equipped with Full DC Inverter technology and R32 refrigerant, for outdoor installation. It is available from 53 kW up to 85 kW and is the most effective and valuable solution both in terms of capital investment and running costs.

## Energy efficiency

Class A Eurovent at full load in heating and in cooling.  
SCOP up to 4,08, which reaches the A++ class according to EU Regulation 811/2013 (ErP) with low water temperature (LWT 35°C).  
SEER up to 4,64 which makes it extremely competitive even compared to the cooling only units.  
Capacity modulation from 30% to 100%.

## Wide operating range

Outdoor air temperature	max	min
• heating mode	43 °C	-15 °C
• domestic hot water mode	43 °C	-15 °C
• cooling mode	48 °C	-10 °C
Outlet water temperature	max	min
• heating mode	55 °C	25 °C
• domestic hot water mode	55 °C	15 °C
• cooling mode	20 °C	5 °C

## Functionality

Management and production of domestic hot water up to 55 ° C.  
Climate compensation with outdoor temperature.

ECO mode

- temperature set for maximum comfort (for example during the day)
- temperature set for maximum energy saving (for example at night)
- time bands and customizable temperatures

SILENT mode

- speed reduction of compressors and fans
- three levels of silence: standard mode, silenced, super silenced

## Modular design

ELFOEnergy Storm EVO was designed for modularity. It is possible to connect up to 16 units in a local network, reaching a maximum capacity of 1360 kW and up to 4 units connected hydraulically. The combinations can also take place with different capacity units. The modular system, obtained by combining several modules, preserves the strengths of the single module, but multiplies the advantages:

- Increased system efficiency
- Higher reliability
- Simplified handling and installation
- Quick and easy maintenance
- Scalability

## Application Versatility

All the main system components are integrated in the unit, assuring the best reliability and an easy installation:

- Hydronic assembly with 1 inverter pump.
- Valvola 3 vie per la gestione dell'acqua calda sanitaria.
- System storage tank: 170 (size 18.2-20.2) or 275 liters (size 25.2-30.2-35.2).

## Technology

The technical solutions adopted place ELFOEnergy Storm EVO on top of its category:

- DC inverter technology on compressors and fans
- Electronic expansion valve
- Flow switch
- Hydrophilic battery

## Tax credit

Due to its high efficiency, ELFOEnergy Storm EVO may be eligible for heat pump subsidies in Your Country.

## Perfect for LEED

All models satisfy prerequisites 2 (Minimum Energy Performance) and 3 (Fundamental Refrigerant Management) of Energy and Environment thematic area of LEED certification.

## Compressor

### Size 18.2 - 20.2

Inverter controlled rotary-type hermetic compressor equipped with a motor protection device for overheating, overcurrents and excessive temperatures of the supply gas. It is installed on anti-vibration mounts and it is equipped with oil charge. The compressor is wrapped in a sound-absorbing hood, that reduces its sound emissions and it thermally insulates it. A crankcase heater, which starts automatically, keeps the oil from being diluted by the refrigerant when the compressor stops.

Compressors are connected in tandem on a single refrigerating circuit with a dedicated system for the oil recovery.

### Size 25.2 - 30.2 - 35.2

Scroll hermetic compressor with steam injection controlled by inverter, complete with motor over-temperature and over-current devices and protection against excessive gas discharge temperature. It is installed on anti-vibration mounts and it is equipped with oil charge. The compressor is wrapped in a sound-absorbing hood, that reduces its sound emissions and it thermally insulates it.

A crankcase heater, which starts automatically, keeps the oil from being diluted by the refrigerant when the compressor stops.

Compressors are connected in tandem on a single refrigerating circuit with a dedicated system for the oil recovery.

## Structure

Supporting structure realised with steel with zinc-magnesium superficial treatment painted with polyester powder RAL 9001, that ensures excellent mechanical features and high long-term resilience against corrosion.

## Panelling

External RAL 9001 painted zinc-magnesium sheet metal panelling that ensures superior resistance to corrosion for outdoor installation and eliminates the need for periodic painting. Each panel can be easily removed to allow full access to internal components.

## Internal exchanger

Direct expansion heat exchanger, brazed AISI 316 stainless steel plates, in pack without seals using copper as the brazing material, with low refrigerant charge and large exchange surface.

The exchanger comes complete with:

- external thermal insulation no-condensation, thickness 17 mm, in expanded polypropylene (EPP)
- antifreeze heater to protect the water side exchanger, preventing the formation of frost if the water temperature falls below a set value.
- flow switch
- anti-ice probe

## External exchanger

Direct expansion finned coil exchanger made with copper pipes placed on staggered rows mechanically expanded to better adhere to the fin collar.

Fins are made from aluminum with hydrophobic treatment that allows the correct evacuation of condensing water and optimizes defrosting.

Fins have a special corrugated surface and they are appropriately distanced to ensure the maximum heat exchange efficiency.

## Fan

Helical fans with 4 profiled blades made of reinforced plastic, directly coupled to the DC brushless motor with electronic control, IP 54 execution.

Fans are located in aerodynamically shaped structures to increase efficiency and minimize noise level, equipped with accident prevention steel guards.

## Refrigeration circuit

Refrigeration circuit with:

- filter dryer
- liquid receiver
- pressure transducer (high/low)
- refrigerant temperature probe
- electronic expansion valves
- non return valve

- 4-way reverse-cycle valve
- high pressure safety pressure switch
- low pressure safety pressure switch
- low pressure safety valve
- inlet liquid separator
- oil separator
- high compressor discharge temperature safety thermostat
- cooling system of the of the electrical control panel using undercooled liquid

Only for size 25.2 - 30.2 - 35.2:

- economiser exchanger

## Electrical panel

- main door lock isolator switch
- phase monitor
- auxiliary components protection fuse
- compressor protection fuse
- fan motor thermal protections
- interface terminal with graphic display
- intuitive graphical interface retro lighted
- display of operating status
- Unit On/Off and overload reset
- manual changing of the operating mode (hot or cold)
- management of the operating parameters
- daily, weekly programmer of temperature set-point and unit on/off
- self-diagnosis system with immediate display of the fault code
- compressor overload protection and timer
- relay for remote cumulative fault signal
- potential-free contact for remote on-off control
- potential-free contact for summer / winter change
- potential-free contacts for compressor status
- serial port with modbus port (RS485) for remote communication

## Test

Unit subjected to factory-tested in specific steps and test pressure of the piping of the refrigerant circuit (with nitrogen and hydrogen), before shipping them.

# Unit configuration

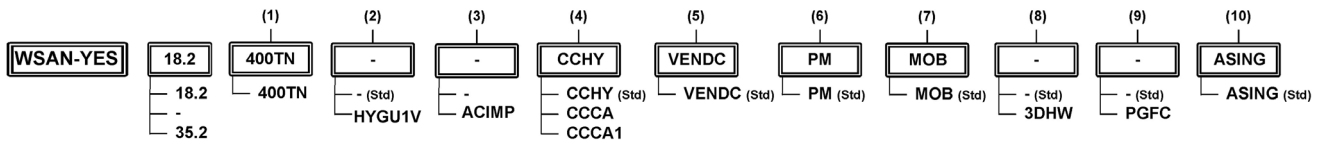

## (1) Voltage

400TN - Supply voltage 400/3/50 + N (standard)

## (2) User side hydronic unit

(-) not required (standard)

HYGU1V - User side hydronic assembly with 1 inverter pump

## (3) Storage tank

(-) not required (standard)

ACIMP- Steel inertial storage tank

## (4) Condensing coil

CCHY - Hydrophilic aluminium fins coil (standard)

CCCA - Copper / aluminium condenser coil with acrylic lining

CCCA1 - Condenser coil with Aluminium Energy Guard DCC treatment

## (5) Fans

VENDC - DC high efficiency fans (standard)

## (6) Phase monitor

PM - Phase monitor (standard)

## (7) Serial communication module Modbus

MOB - Serial port RS485 with modbus protocol (standard)

## (8) Domestic hot water valve

(-) not required (standard)

3DHW- Built-in 3 way valve for domestic hot water on the unit

## (9) Protection grill

(-) not required (standard)

PGFC - Finned coil protection grill

## (10) Water fittings

ASING - Water fittings for single unit (standard)

Accessory		Description
HYGU1V	User side hydronic group with 1 inverter pump	<p>Hydronic unit made of a centrifugal electric pump, adjusted by way of inverter, body and propeller made in AISI 304 steel. The electric pump is equipped with three-phase electric motor with IP55 protection and complete with heat formed insulating casing. The water connection are 2"Vicaltic.</p> <p>Hydronic unit performance is available on page 14 and 15.</p>
ACIMP	Steel inertial storage tank	<p>Option supplied built-in the unit. Steel storage tank complete with double layer covering with closed-cell insulation, stainless steel anti-freeze immersion resistance, bleed valve, draw off cock, cast-iron shut-off butterfly valve with quick connections and activation lever with a mechanical calibration lock at the evaporator output, quick connections with insulated casing.</p> <p>The storage tank capacity is 170 liters for size 18.2 and 20.2. The storage tank capacity is 275liters for size 25.2, 30.2 and 35.2</p>
CCCA	Copper / aluminium condenser coil with acrylic lining	<p>Coils with copper pipes and aluminium fins with acrylic lining. Resist bi-metallic corrosion and allow for application in coastal areas.</p> <p>Attention!</p> <ul style="list-style-type: none"> <li>- Cooling capacity variation -2.7%</li> <li>- Variation in compressor power input +4.2%</li> <li>- Operating range reduction -2.1°C</li> </ul>
CCCA1	Condenser coil with Aluminum Energy Guard DCC treatment	<p>A treatment which offers an optimal thermal exchange and guarantees and protects the finned coil exchangers from corrosion over time. Can be used in settings with very aggressive saline concentrations and other chemical agents in the air thus maintaining the performance of the coils over time.</p>
3DHW	Built-in 3-way valve for domestic hot water on the unit	<p>The 3-way diverter valve deviating the water flow towards a heating storage tank for domestic water is installed on the side of the unit.</p> <p>If the temperature of the ACS is under the set-point, ELFOEnergy Storm EVO changes to ACS production mode (priority compared to other operational modes can be set).</p> <p>The unit controller closes a digital output driving the flow deviation valve from the storage system until it reaches the ACS set-point set on the user interface.</p> <p>The water connections are 2"Vicaltic</p> <p><b>3-way valve pressure drop</b></p> <p>Q = Water flow rate [l/s] Dp = Water side pressure drops [kPa]</p> <p><b>!!</b> The maximum nominal pressure of the unit with the 3-way valve option is 6bar</p>
PGFC	Finned coil protection grill	<p>The grilles protect the external coil from accidental contact with objects or persons. Ideal for installation in places where persons can pass from, such as car parks, terraces, etc</p>

# Options separately supplied

Accessory		Description
IFWX	Steel mesh strainer on the water side	<p>The device stops the exchanger from being clogged by any impurities which are in the hydraulic circuit. The mechanical steel mesh strainer must be placed on the water input line. It can be easily dismantled for periodical maintenance and cleaning.</p> <p>Filter fittings are Victaulic type by 2".</p> <p><b>Steel mesh strainer pressure drops</b></p> <p><math>Q</math> = Water flow rate [l/s]  <math>DP</math> = Water side pressure drops [kPa]</p> <p>This accessory is not available for modular system.</p>
AVIBX	Anti-vibration mount support	<p>The rubber antivibration mounts are attached in special housing on the support frame and serve to smooth the vibrations produced by the unit thus reducing the noise transmitted to the support structure.</p>
PGFCX	Finned coil protection grill	<p>The grilles protect the external coil from accidental contact with objects or persons. Ideal for installation in places where persons can pass from, such as car parks, terraces, etc</p>
AMODX	Water fitting for modular unit	<p>In order to configure a modular system, each unit must be selected with the water connections for modular unit. The kit is made of 2 4" collectors placed horizontally and 2 butterfly valves that make it possible to exclude the unit from the modular system in case of malfunction. The water outputs remain in the same position of the individual unit, only the diameters of the pipes, which are 4", are changed.</p>

## Performance

Size			18.2	20.2	25.2	30.2	35.2
<b>Radiant panels</b>							
<b>Heating</b>							
Heating capacity (EN 14511:2013)	1	kW	54,4	61,3	65,3	79,4	87,7
COP (EN 14511:2013)	2		4,07	4,00	4,29	4,17	4,15
ErP Space Heating Energy Class - AVERAGE Climate - W35	9		A++	A++	A++	-	-
SCOP - Average Climate - W35	8		4,04	4,03	4,08	4,07	4,06
<b>Cooling</b>							
Cooling capacity (EN 14511:2013)	5	kW	62,4	72,3	89,2	95,1	107
EER (EN 14511:2013)	6		4,14	3,93	4,18	4,10	4,04
Water flow-rate	5	l/s	3,05	3,20	4,27	4,60	4,80
User side internal exchanger pressure drops	5	kPa	35,6	38,9	47,0	54,2	58,8
<b>Terminal Unit</b>							
<b>Heating</b>							
Heating capacity (EN 14511:2013)	3	kW	53,3	66,7	79,1	85,0	91,2
COP (EN 14511:2013)	2		3,21	3,21	3,33	3,29	3,25
<b>Cooling</b>							
Cooling capacity (EN 14511:2013)	7	kW	53,1	58,8	72,4	78,4	85,3
EER (EN 14511:2013)	6		2,95	2,90	3,15	3,10	2,91
SEER	8		4,57	4,51	4,64	4,62	4,50
Water flow-rate	7	l/s	2,58	2,84	3,44	3,74	4,12
User side internal exchanger pressure drops	7	kPa	26,0	31,2	31,1	36,5	43,9
<b>Radiators</b>							
<b>Heating</b>							
Heating capacity (EN 14511:2013)	4	kW	54,0	63,3	78,6	85,6	92,6
COP (EN 14511:2013)	2		2,72	2,61	2,59	2,57	2,53
Water flow-rate	4	l/s	2,30	2,94	3,59	3,92	4,16
User side internal exchanger pressure drops	4	kPa	21,0	33,2	33,7	39,9	44,7
<b>AHRI data</b>							
Cooling capacity (AHRI 550/590)	10	kW	52,6	58,3	72,3	77,8	84,6
Total power input (AHRI 550/590)	10	kW	17,1	20,1	23,0	25,2	28,9
COP <sub>R</sub>	10		3,08	2,90	3,14	3,09	2,93
IPLV	10		4,94	4,87	4,94	4,92	4,79

The Product is compliant with the ErP (Energy Related Products) European Directive. It includes the Commission delegated Regulation (EU) No 811/2013 (rated heat output ≤ 70 kW at specified reference conditions) and the Commission delegated Regulation (EU) No 813/2013 (rated heat output ≤ 400 kW at specified reference conditions)

Contains fluorinated greenhouse gases (GWP 2087,5)

1. Entering/leaving water temperature user side 30/35 °C, Entering external exchanger air temperature 7 °C (R.H. = 85%)
2. COP (EN 14511:2013) Heating performance coefficient. Ratio between delivered heating capacity and power input in compliance with EN 14511:2013.
3. Entering/leaving water temperature user side 40/45 °C, Entering external exchanger air temperature 7 °C (R.H. = 85%)
4. Entering/leaving water temperature user side 50/55 °C, Entering external exchanger air temperature 7 °C (R.H. = 85%)
5. Entering/leaving water temperature user side 23/18 °C, Entering external exchanger air temperature 35 °C
6. EER (EN 14511:2013) cooling performance coefficient. Ratio between delivered cooling capacity and power input in compliance with EN 14511:2013
7. User side entering/leaving water temperature 12/7 °C, external exchanger entering air 35 °C
8. Data referred to unit operation with inverter frequency optimized for this application.
9. Data calculated according to the EN 14825:2016 Regulation
10. Seasonal Space Heating Energy Efficiency Class according to Commission delegated Regulation (EU) No 811/2013. W = Water outlet temperature (°C)
11. Data compliant to Standard AHRI 550/590 referred to the following conditions: internal exchanger water temperature = 6,7 °C. Water flow-rate 0,043 l/s per kW. Entering external exchanger air temperature 35 °C. Evaporator fouling factor =  $0.18 \times 10^{(-4)}$  m<sup>2</sup> K/W



# General technical data

## Construction

Size			18.2	20.2	25.2	30.2	35.2
<b>Compressor</b>							
Compressor type			ROTARY INVERTER		SCROLL INVERTER		
Refrigerant			R32				
N° compressor		Nr	2	2	2	2	2
Oil charge		l	5	5	6	6	6
Refrigerant charge		Kg	15,0	15,0	21,0	21,0	21,0
N° circuits		Nr	1	1	1	1	1
<b>User side exchanger</b>							
Type of internal exchanger	1		BPHE				
Water content		l	5,7	5,7	7,8	7,8	7,8
<b>External Section Fans</b>							
Fans type			BRUSHLESS DC MOTOR				
N° fans		Nr	2	2	3	3	3
Standard air-flow		l/s	6889	6889	10333	10333	10333
Installed unit power		kW	0,9	0,9	0,9	0,9	0,9
<b>Water circuit</b>							
Maximum water side pressure		MPa	1	1	1	1	1
Minimum circuit water volume in heating	2	l	400	400	620	620	620
Minimum circuit water volume in cooling	3	l	150	150	200	200	200
Total internal water volume		l	5,9	5,9	8,0	8,0	8,0
<b>Power supply</b>							
Standard power supply			400/3/50+N	400/3/50+N	400/3/50+N	400/3/50+N	400/3/50+N

1. BPHE = plate exchanger

2. Entering/leaving water temperature user side 25/30 °C, external exchanger entering air 2°C (U.R. = 85%) - Minimum water volume that does not consider the volume of water inside the unit.

3. Entering/leaving water temperature user side 15/10 °C, external exchanger entering air 25°C (U.R. = 85%) - Minimum water volume that does not consider the volume of water inside the unit.

## Electrical data

### Supply voltage 400/3/50+N

Size			18.2	20.2	25.2	30.2	35.2
<b>F.L.A. Full load current at max admissible conditions</b>							
F.L.A. - Total		[A]	38,5	38,5	59,7	59,7	59,7
<b>F.L.I. Full load power input at max admissible conditions</b>							
F.L.I. - Total		[kW]	25,6	25,6	40,1	40,1	40,1
<b>M.I.C. Maximum inrush current</b>							
M.I.C. - Total		[A]	46,0	46,0	60,2	60,2	60,2

Power supply 400/3/50 (+ NEUTRAL) +/- 10%.

Maximum Phase Unbalance: 2%.

For non standard voltage please contact Clivet technical office

## Sound levels Standard Mode

Size	Sound power level								Sound pressure level	Sound power level
	Octave band (Hz)									
	63	125	250	500	1000	2000	4000	8000	dB(A)	dB(A)
18.2	62	67	68	72	79	72	64	52	64	82
20.2	68	79	76	73	76	67	59	52	65	82
25.2	65	66	69	73	80	73	65	51	62	81
30.2	59	67	69	72	80	73	65	51	65	84
35.2	87	77	76	76	79	68	60	53	67	85

Sound levels refer to units with nominal test conditions.  
The sound pressure level refers to a distance of 1 meter from the outer surface of the unit operating in open field.  
Noise levels are determined using the tensiometric method (UNI EN ISO 9614-2)

Data referred to the following conditions in heating:  
- internal exchanger water = 30/35°C  
- ambient temperature 7/6 °C  
Data referred to the following conditions in cooling:  
- internal exchanger water = 12/7°C  
- ambient temperature 35°C

## Silenced Mode

Size	Sound power level								Sound pressure level	Sound power level
	Octave band (Hz)									
	63	125	250	500	1000	2000	4000	8000	dB(A)	dB(A)
18.2	54	57	62	67	66	64	57	46	56	74
20.2	73	65	70	69	65	62	55	49	56	74
25.2	66	57	60	68	67	65	56	43	58	76
30.2	61	55	59	67	66	63	55	41	58	76
35.2	86	67	69	70	63	58	54	47	58	76

Sound levels refer to units with nominal test conditions.  
The sound pressure level refers to a distance of 1 meter from the outer surface of the unit operating in open field.  
Noise levels are determined using the tensiometric method (UNI EN ISO 9614-2)

Data referred to the following conditions in heating:  
- internal exchanger water = 30/35°C  
- ambient temperature 7/6 °C  
Data referred to the following conditions in cooling:  
- internal exchanger water = 12/7°C  
- ambient temperature 35°C

Silenced mode can be set from the user interface terminal

## Super Silenced Mode

Size	Sound power level								Sound pressure level	Sound power level
	Octave band (Hz)									
	63	125	250	500	1000	2000	4000	8000	dB(A)	dB(A)
18.2	48	51	57	62	58	61	56	44	52	70
20.2	68	64	70	64	59	62	54	48	53	71
25.2	69	58	59	66	62	59	51	40	53	71
30.2	61	49	56	64	61	59	52	39	53	71
35.2	86	63	58	68	60	56	54	48	55	73

Sound levels refer to units with nominal test conditions.  
The sound pressure level refers to a distance of 1 meter from the outer surface of the unit operating in open field.  
Noise levels are determined using the tensiometric method (UNI EN ISO 9614-2)

Data referred to the following conditions in heating:  
- internal exchanger water = 30/35°C  
- ambient temperature 7/6 °C  
Data referred to the following conditions in cooling:  
- internal exchanger water = 12/7°C  
- ambient temperature 35°C

Super Silenced mode can be set from the user interface terminal

## At maximum conditions data

Size	Sound power level								Sound pressure level	Sound power level
	Octave band (Hz)									
	63	125	250	500	1000	2000	4000	8000	dB(A)	dB(A)
18.2	55	65	67	72	77	70	61	50	67	83
20.2	55	65	67	72	77	70	61	50	67	83
25.2	57	67	69	73	79	72	64	51	69	85
30.2	57	67	69	73	79	72	64	51	69	85
35.2	57	67	69	73	79	72	64	51	69	85

Sound levels refer to units with maximum test conditions. The sound pressure level refers to a distance of 1 meter from the outer surface of the unit operating in open field. Noise levels are determined using the tensiometric method (UNI EN ISO 9614-2)

# General technical data

## Performance correction factors- Silenced Mode

Size		18.2	20.2	25.2	30.2	35.2
Cooling capacity factor	Nr	0,930	0,930	0,930	0,930	0,930
Total power input factor	Nr	1,000	1,000	1,000	1,000	1,000
EER factor	Nr	0,930	0,930	0,930	0,930	0,930
Heating capacity factor	Nr	0,950	0,950	0,950	0,950	0,950
Total power input factor	Nr	0,950	0,950	0,950	0,950	0,950
COP factor	Nr	1,000	1,000	1,000	1,000	1,000

## Performance correction factors - Super Silenced Mode

Size		18.2	20.2	25.2	30.2	35.2
Cooling capacity factor	Nr	0,880	0,880	0,880	0,880	0,880
Total power input factor	Nr	1,020	1,020	1,020	1,020	1,020
EER factor	Nr	0,860	0,860	0,860	0,860	0,860
Heating capacity factor	Nr	0,900	0,900	0,900	0,900	0,900
Total power input factor	Nr	0,900	0,900	0,900	0,900	0,900
COP factor	Nr	1,000	1,000	1,000	1,000	1,000

## Correction factors for glycol use

% ethylene glycol by weight		0%	10%	20%	30%	40%	50%
Freezing point	°C	0	-4	-9	-16	-23	-37
Correction factor for unit cooling capacity	Nr	1	0,984	0,973	0,965	0,96	0,95
Correction factor for flow rate	Nr	1	1,019	1,051	1,092	1,145	1,2
Correction factor for system pressure drop	Nr	1	1,118	1,268	1,482	1,791	2,1

The correction factors shown refer to water and glycol ethylene mixes used to prevent the formation of frost on the exchangers in the water circuit during inactivity in winter.

## Fouling Correction Factors

m <sup>2</sup> K/W	Internal exchanger	
	F1	FK1
0,44x10 <sup>(-4)</sup>	-	-
0,88x10 <sup>(-4)</sup>	0,96	0,99
1,76x10 <sup>(-4)</sup>	0,93	0,98

The cooling performance values provided in the tables are based on the external exchanger having clean plates (fouling factor 1). For different fouling factor values, multiply the performance by the coefficients shown in the table.

F1 = Cooling capacity correction factors

FK1 = Compressor power input correction factor

## Overload and control device calibrations

		Open	Close	Value
<b>Refrigerant side</b>				
High pressure safety switch	kPa	4200	3200	-
Low pressure safety switch	kPa	50	130	-
Low pressure safety valve	kPa	-	-	3000
Compressor discharge high temperature safety thermostat	°C	115	75	-
<b>Water side</b>				
Antifreeze protection	°C	4	20	-
High pressure safety valve	kPa	-	-	600*

\* The value entered refers to units supplied with a hydronic group installed on board.

## Operating range - Cooling

Size 18.2 - 20.2 - 25.2 - 30.2 - 35.2

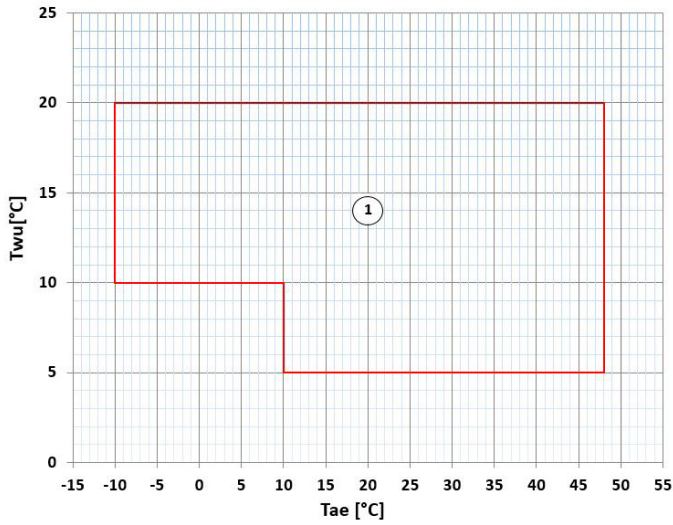

$T_{wu}$  [°C] = Leaving exchanger water temperature  
 $T_{ae}$  [°C] = External exchanger inlet air temperature  
 1. Normal operating range

## Operating range - Heating

Size 18.2 - 20.2

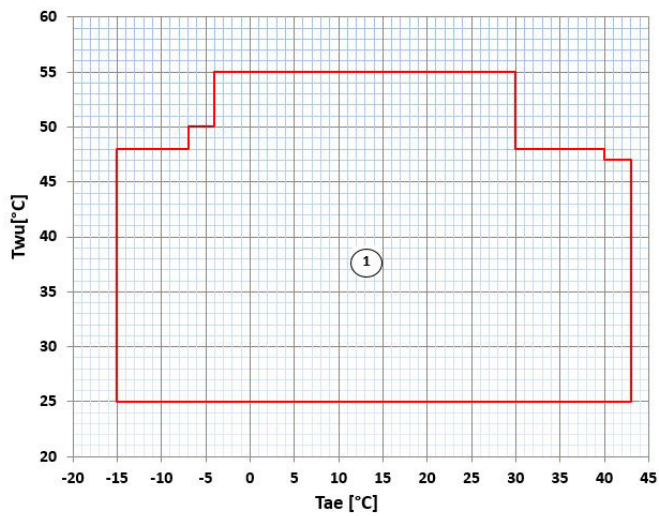

$T_{wu}$  [°C] = Leaving exchanger water temperature  
 $T_{ae}$  [°C] = External exchanger inlet air temperature  
 1. Normal operating range

Size 25.2 - 30.2 - 35.2

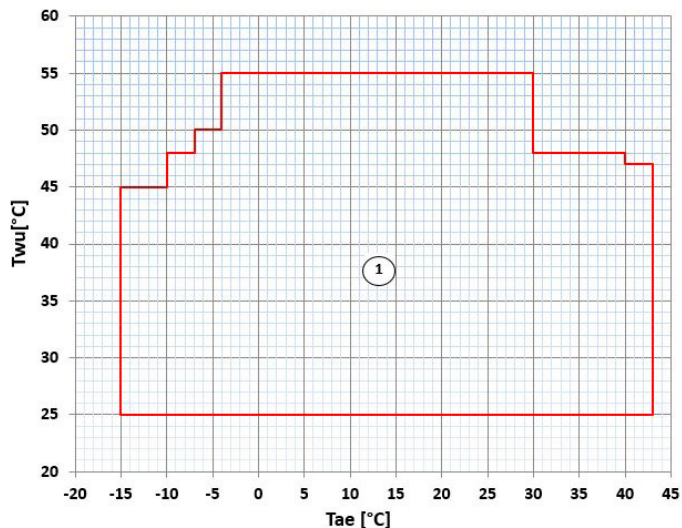

$T_{wu}$  [°C] = Leaving exchanger water temperature  
 $T_{ae}$  [°C] = External exchanger inlet air temperature  
 1. Normal operating range

# General technical data

## Standard Unit

### Internal exchanger pressure drop

Standard unit without hydronic assembly on the user side, but equipped with components as listed on the key of the enclosed plumbing circuit diagram.

It is possible to control an external pump by an on/off or 0-10V signal.

Water fittings are Victaulic type by 2".

#### Internal exchanger pressure drop curves

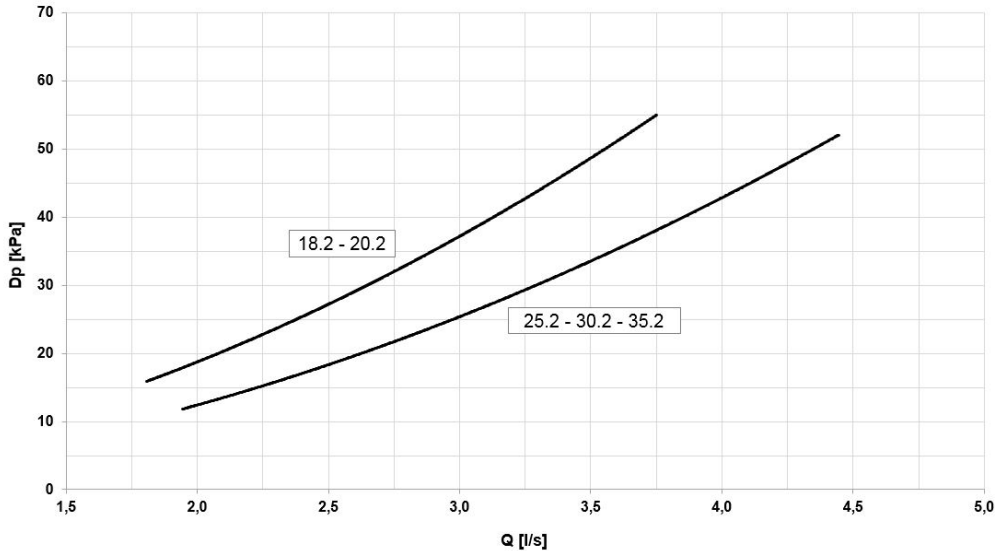

The pressure drops on the water side are calculated by considering an average water temperature at 7°C.

$Q$  = Water flow rate [l/s]  
 $DP$  = Pressure drops [kPa]

The water flow rate must be calculated with the following formula

$$Q \text{ [l/s]} = kWf / (4,186 \times DT)$$

$kWf$  = Cooling capacity in kW  
 $DT$  = Temperature difference between entering / leaving water

To the internal exchanger pressure drops must be added the pressure drops of the steel mesh mechanical filter that must be placed on the water input line. It is a device compulsory for the correct unit operation, and it is provided by Clivet as accessory.

## Admissible water flow rates

Min. ( $Q_{min}$ ) and max. ( $Q_{max}$ ) water flow-rates admissible for the correct unit operation.

Size		18.2	20.2	25.2	30.2	35.2
Minimum flow	[l/s]	1,9	1,9	2,9	2,9	2,9
Maximum flow-rate	[l/s]	6,4	6,4	6,4	6,4	6,4

## Hydraulic diagram

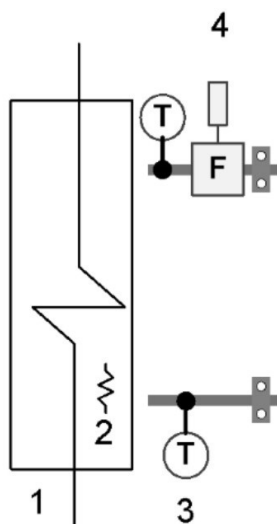

- 1 - Exchanger
- 2 - Anti-freeze resistance
- 3 - Water temperature probe
- 4 - Flow Switch

## Hydronic assembly - Unit with 1 inverter pump (HYGU1V)

This configuration provides for one inverter-controlled electric centrifugal pump with body and impeller in AISI 304 steel and components listed in the key of the included water diagram. The electric pump is equipped with three-phase electric motor with IP55-protection and complete with thermoformed insulated casing.

During the installation phase it is possible to choose the most suitable head curve for system requirements by setting the inverter frequency.

The pump will always work at fixed flow.

Water fittings are Victaulic type by 2".

### Pump available pressure curves size 18.2 - 20.2

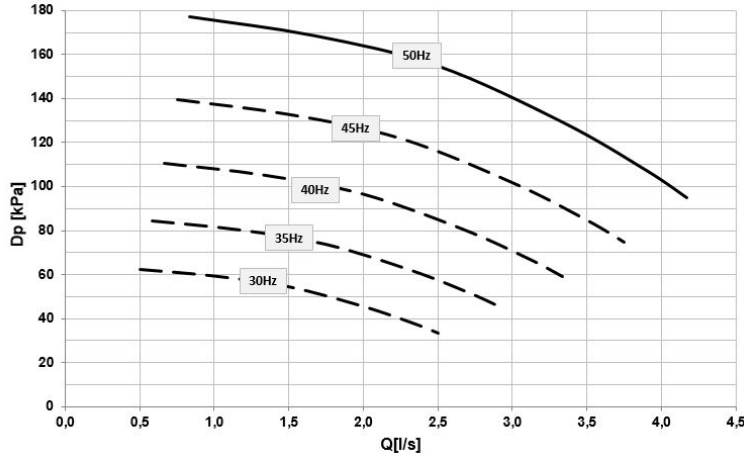

DP = Available pressure [kPa]  
Q = Water flow-rate [l/s]

!! Caution: in order to obtain useful head values, the head represented in these diagrams must be lowered by:

- User side exchanger pressure drops
- IFWX - Steel mesh strainer on the water side" accessory (where present).

### Pump absorption curves size 18.2 - 20.2

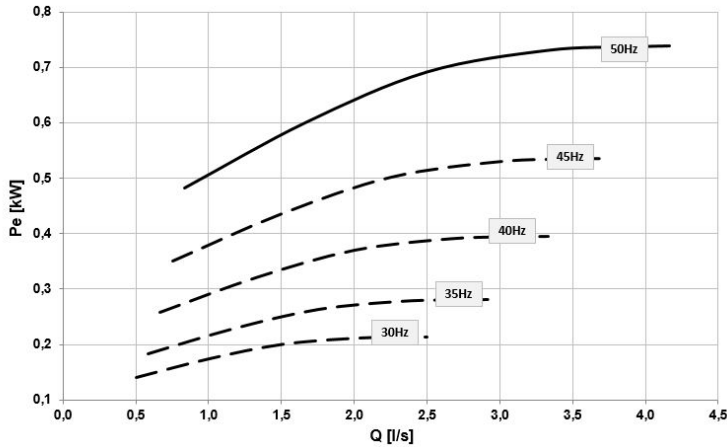

Pe = Power input [kW]  
Q = Water flow-rate [l/s]

### Hydraulic diagram

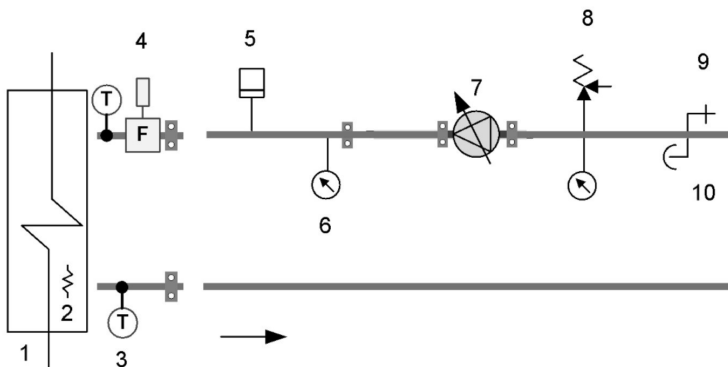

1. Exchanger
2. Antifreeze heater
3. Water temperature probe
4. Flow Switch
5. System load safety pressure switch
6. Pressure gauge
7. Inverter pump
8. Safety valve
9. Discharge
10. Vent

# General technical data

## Hydronic assembly - Unit with 1 inverter pump (HYGU1V)

### Pump available pressure curves size 25.2 - 30.2 - 35.2

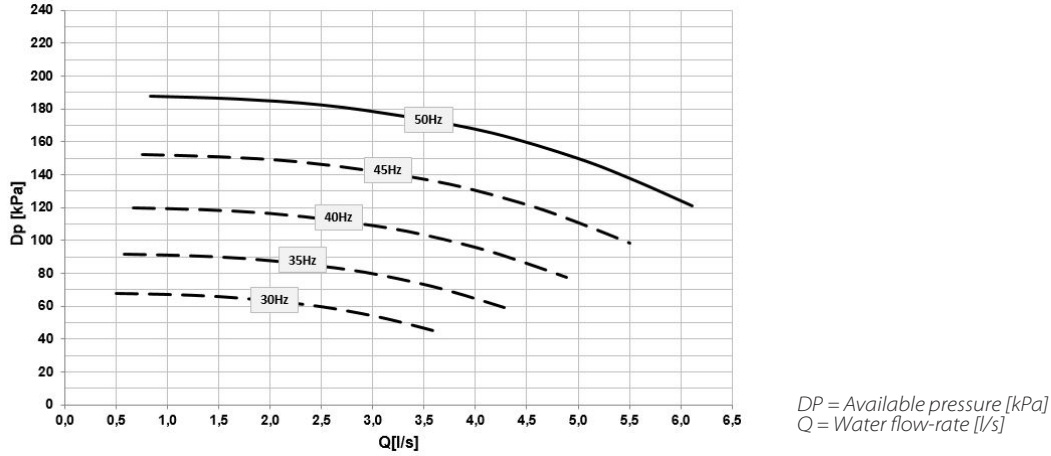

!! Caution: in order to obtain useful head values, the head represented in these diagrams must be lowered by:

- User side exchanger pressure drops
- IFWX - Steel mesh strainer on the water side" accessory (where present).

### Pump available pressure curves size 25.2 - 30.2 - 35.2

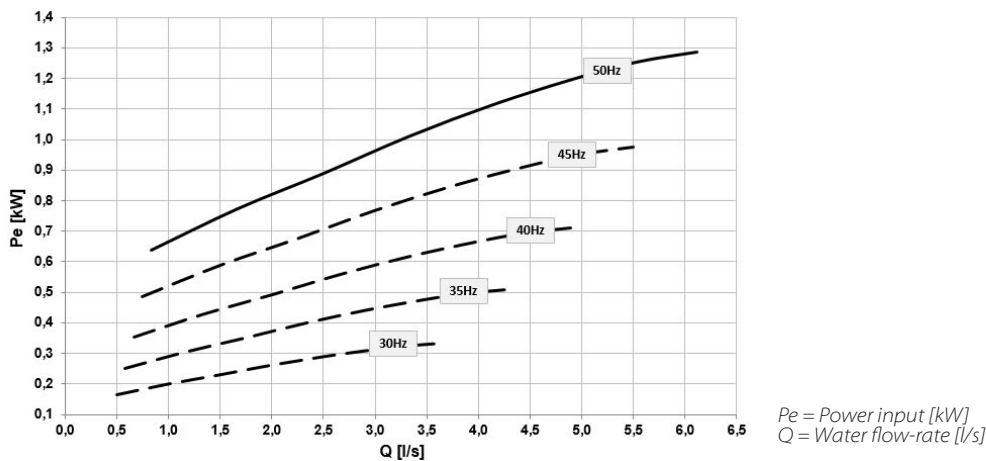

## Electrical data

Size		18.2	20.2	25.2	30.2	35.2
F.L.A.	A	1,90	1,90	2,50	2,50	2,50
F.L.I.	kW	0,75	0,75	1,1	1,1	1,1

Performances in heating - Size18.2

To	Tae (°C) DB/WB	Heating capacity EN14511								COP EN14511							
		Percentage of compressor load								Percentage of compressor load							
°C	°C	100%	90%	80%	70%	60%	50%	40%	min%	100%	90%	80%	70%	60%	50%	40%	min%
25	-10/-11.1	38,1	34,7	30,9	26,2	22,2	17,8	13,7	12,6	3,37	3,20	3,12	3,02	2,93	2,82	2,67	2,51
	-7/-8	41,1	37,8	34,0	29,1	24,8	20,0	15,5	14,4	3,60	3,45	3,40	3,32	3,23	3,13	3,01	2,86
	2/1.1	51,9	48,6	44,3	38,7	33,5	27,3	21,1	19,6	4,45	4,35	4,35	4,32	4,26	4,15	3,97	3,89
	7/6	58,7	55,3	50,6	44,3	38,4	31,4	24,4	22,6	4,98	4,91	4,94	4,94	4,88	4,78	4,58	4,51
	10/8.2	63,1	59,5	54,5	47,9	41,5	34,0	26,3	24,4	5,32	5,27	5,32	5,34	5,29	5,18	4,98	4,89
	18/14	75,0	71,1	65,4	57,5	50,0	40,8	31,5	29,2	6,25	6,27	6,39	6,48	6,48	6,39	6,16	6,07
30	-10/-11.1	37,1	33,8	30,1	25,6	21,7	17,3	13,3	12,3	3,07	2,92	2,85	2,76	2,67	2,57	2,45	2,29
	-7/-8	40,2	37,0	33,2	28,5	24,3	19,5	15,1	14,0	3,28	3,15	3,10	3,03	2,95	2,85	2,73	2,59
	2/1.1	51,1	47,9	43,6	38,0	32,8	26,6	20,5	19,0	4,02	3,94	3,94	3,92	3,86	3,75	3,57	3,50
	7/6	58,0	54,5	49,8	43,6	37,7	30,7	23,6	21,9	4,49	4,43	4,46	4,46	4,41	4,30	4,10	4,03
	10/8.2	62,3	58,7	53,7	47,0	40,7	33,1	25,5	23,6	4,78	4,74	4,78	4,80	4,76	4,65	4,44	4,36
	18/14	74,1	70,1	64,4	56,5	49,0	39,8	30,5	28,3	5,59	5,60	5,71	5,79	5,78	5,69	5,45	5,35
35	-10/-11.1	36,2	33,0	29,4	25,0	21,2	17,0	13,0	12,0	2,80	2,67	2,61	2,53	2,45	2,35	2,22	2,02
	-7/-8	39,4	36,3	32,5	27,9	23,7	19,1	14,7	13,6	2,99	2,87	2,83	2,77	2,69	2,59	2,47	2,29
	2/1.1	50,4	47,1	42,9	37,3	32,1	26,0	19,9	18,5	3,65	3,57	3,58	3,55	3,50	3,39	3,21	3,09
	7/6	54,4	51,3	49,0	42,8	36,9	30,0	22,9	21,2	4,07	4,00	4,02	4,02	3,98	3,87	3,66	3,57
	10/8.2	61,4	57,8	52,8	46,2	39,8	32,3	24,8	22,9	4,31	4,26	4,31	4,32	4,28	4,17	3,95	3,86
	18/14	73,1	69,1	63,3	55,5	47,9	38,8	29,5	27,3	5,00	5,01	5,11	5,17	5,16	5,05	4,80	4,70
40	-10/-11.1	35,4	32,3	28,8	24,6	20,8	16,5	12,8	11,8	2,56	2,44	2,39	2,32	2,25	2,12	2,01	1,91
	-7/-8	38,6	35,6	32,0	27,4	23,3	18,8	14,4	13,4	2,73	2,63	2,59	2,54	2,47	2,37	2,24	2,14
	2/1.1	49,7	46,4	42,2	36,7	31,5	25,4	19,4	17,9	3,32	3,25	3,25	3,23	3,18	3,06	2,88	2,80
	7/6	56,4	52,9	48,2	42,0	36,2	29,2	22,2	20,5	3,67	3,62	3,65	3,64	3,59	3,48	3,26	3,18
	10/8.2	60,6	57,0	52,0	45,3	39,0	31,5	24,0	22,1	3,89	3,85	3,89	3,90	3,85	3,73	3,50	3,42
	18/14	72,1	68,0	62,2	54,4	46,8	37,7	28,5	26,3	4,50	4,50	4,58	4,63	4,60	4,48	4,21	4,11
45	-10/-11.1	34,7	31,8	28,4	24,2	20,6	16,4	12,6	11,7	2,34	2,24	2,19	2,14	2,07	1,93	1,83	1,75
	-7/-8	38,0	35,0	31,5	27,0	23,0	18,5	14,2	13,2	2,50	2,41	2,38	2,33	2,26	2,17	2,04	1,95
	2/1.1	49,0	45,8	41,5	36,1	30,9	24,9	18,9	17,4	3,01	2,95	2,96	2,94	2,88	2,76	2,57	2,50
	7/6	53,3	50,6	47,5	41,3	35,4	28,5	21,5	19,9	3,21	3,19	3,20	3,17	3,14	3,08	2,89	2,82
	10/8.2	59,8	56,1	51,1	44,5	38,2	30,7	23,2	21,3	3,51	3,48	3,51	3,51	3,46	3,33	3,09	3,01
	18/14	71,0	66,9	61,0	53,2	45,6	36,6	27,4	25,2	4,03	4,03	4,10	4,13	4,09	3,96	3,68	3,57
50	-10/-11.1	-	-	-	-	-	-	-	-	-	-	-	-	-	-	-	-
	-7/-8	37,4	34,5	31,1	26,7	22,8	18,3	14,0	13,1	2,29	2,21	2,18	2,14	2,08	1,99	1,87	1,75
	2/1.1	48,3	45,1	40,9	35,5	30,4	24,3	18,4	17,0	2,74	2,69	2,69	2,67	2,61	2,50	2,33	2,22
	7/6	54,8	51,3	46,7	40,5	34,7	27,8	20,9	19,2	3,01	2,97	2,99	2,97	2,92	2,80	2,57	2,48
	10/8.2	58,8	55,2	50,2	43,6	37,3	29,9	22,3	20,5	3,17	3,14	3,17	3,16	3,11	2,98	2,73	2,65
	18/14	69,7	65,6	59,7	51,9	44,4	35,4	26,3	24,0	3,61	3,61	3,67	3,69	3,64	3,50	3,21	3,10
55	2/1.1	47,6	44,5	40,3	34,9	29,9	23,9	18,0	16,5	2,50	2,45	2,45	2,43	2,37	2,26	2,02	2,00
	7/6	54,0	50,5	45,8	39,7	33,9	27,1	20,2	18,6	2,72	2,69	2,70	2,69	2,63	2,50	2,26	2,23
	10/8.2	57,9	54,2	49,2	42,6	36,4	29,0	21,5	19,8	2,86	2,83	2,86	2,85	2,79	2,65	2,40	2,36
	18/14	68,3	64,1	58,3	50,5	43,1	34,1	25,1	23,0	3,23	3,23	3,27	3,29	3,23	3,08	2,78	2,73

To = Leaving internal exchanger water temperature (°C)

Tae [°C]= External exchanger inlet air temperature

Performances in function of the inlet/outlet water temperature differential = 5°C

Heating capacity and COP calculated according to EN 14511:2018

ATTENTION: The data of the heat capacity and COP include defrostings.



# General technical data

## Performances in cooling - Size 18.2

To	Tae	Cooling capacity EN14511								EER EN14511							
		Percentage of compressor load								Percentage of compressor load							
°C	°C	100%	90%	80%	70%	60%	50%	40%	min%	100%	90%	80%	70%	60%	50%	40%	min%
5	10	62,8	56,0	49,8	44,7	39,5	33,1	27,2	25,3	5,95	6,04	6,23	6,32	6,39	6,45	6,48	6,51
	15	60,2	53,7	47,7	42,8	37,8	31,6	25,8	24,0	5,12	5,20	5,37	5,45	5,50	5,54	5,53	5,55
	25	55,0	49,1	43,6	39,1	34,4	28,5	23,0	21,3	3,88	3,94	4,08	4,15	4,18	4,17	4,12	4,12
	35	49,7	44,3	39,4	35,2	30,8	25,3	20,2	18,6	2,95	3,00	3,09	3,14	3,14	3,10	2,99	2,97
	45	44,1	39,4	34,9	31,2	27,1	22,0	17,3	15,7	2,23	2,27	2,33	2,35	2,33	2,25	2,19	2,07
7	10	66,9	59,7	53,1	47,7	42,2	35,3	28,9	26,9	6,28	6,40	6,63	6,77	6,83	6,91	6,94	7,00
	15	64,2	57,3	51,0	45,8	40,4	33,6	27,4	25,5	5,40	5,50	5,70	5,82	5,88	5,92	5,91	5,94
	25	58,8	52,5	46,7	41,8	36,8	30,4	24,5	22,7	4,08	4,17	4,32	4,41	4,44	4,44	4,38	4,38
	35	53,1	47,5	42,2	37,7	33,0	27,0	21,5	19,8	2,95	3,16	3,27	3,33	3,34	3,29	3,16	3,15
	45	47,3	42,3	37,5	33,4	29,0	23,5	18,3	16,7	2,35	2,39	2,47	2,49	2,47	2,38	2,22	2,19
10	10	73,1	65,3	58,1	52,2	46,1	38,5	31,4	29,2	6,69	6,85	7,15	7,32	7,41	7,50	7,53	7,58
	15	70,4	62,9	56,0	50,3	44,3	36,8	30,0	27,8	5,82	5,96	6,22	6,37	6,47	6,53	6,53	6,60
	25	64,6	57,8	51,4	46,0	40,4	33,4	26,9	24,8	4,40	4,51	4,70	4,81	4,86	4,88	4,80	4,82
	35	58,5	52,3	46,5	41,5	36,3	29,7	23,5	21,6	3,34	3,42	3,55	3,62	3,63	3,59	3,45	3,44
	45	52,1	46,6	41,3	36,8	32,0	25,8	20,0	18,2	2,53	2,58	2,67	2,70	2,68	2,59	2,40	2,37
15	10	84,2	75,4	67,1	60,3	53,1	44,2	35,9	33,3	7,50	7,78	8,23	8,51	8,72	8,89	9,00	9,09
	15	81,3	72,7	64,7	58,1	51,1	42,4	34,3	31,7	6,53	6,76	7,14	7,38	7,55	7,69	7,72	7,81
	25	74,9	67,0	59,5	53,3	46,8	38,5	30,8	28,4	4,95	5,10	5,36	5,53	5,63	5,67	5,60	5,64
	35	67,9	60,8	54,0	48,2	42,0	34,2	27,0	24,8	3,75	3,86	4,03	4,13	4,16	4,13	3,97	3,96
	45	60,6	54,2	48,0	42,7	37,0	29,7	22,8	20,8	2,84	2,91	3,02	3,07	3,06	2,95	2,74	2,69
18	10	91,2	81,7	72,7	65,3	57,5	47,7	38,6	36,2	7,98	8,35	8,92	9,30	9,58	9,87	10,0	10,1
	15	88,1	78,9	70,2	62,9	55,3	45,8	36,9	34,6	6,96	7,26	7,72	8,03	8,27	8,49	8,59	8,58
	25	81,3	72,7	64,6	57,8	50,7	41,6	33,2	31,0	5,28	5,48	5,78	5,99	6,12	6,20	6,15	6,09
	35	73,8	62,4	58,6	52,3	45,6	37,0	29,1	27,0	4,00	4,14	4,34	4,46	4,51	4,47	4,31	4,23
	45	65,8	58,9	52,1	46,3	40,1	32,1	24,6	22,8	3,03	3,11	3,25	3,30	3,29	3,18	2,95	2,94
20	10	95,9	85,9	76,5	68,7	60,4	50,1	40,5	38,0	8,31	8,74	9,39	9,84	10,2	10,6	10,8	10,9
	15	92,7	83,0	73,9	66,2	58,2	48,1	38,7	36,2	7,25	7,59	8,12	8,50	8,78	9,06	9,21	9,22
	25	85,6	76,6	68,0	60,9	53,3	43,7	34,8	32,5	5,50	5,73	6,07	6,30	6,46	6,57	6,54	6,49
	35	77,7	69,5	61,7	55,0	47,9	38,9	30,5	28,3	4,17	4,32	4,55	4,68	4,75	4,73	4,57	4,48
	45	69,3	62,0	54,9	48,7	42,1	33,7	25,8	23,9	3,16	3,25	3,40	3,46	3,45	3,35	3,11	3,10

To = Leaving internal exchanger water temperature (°C)

Tae [°C]= External exchanger inlet air temperature

Performances in function of the inlet/outlet water temperature differential = 5°C

Cooling capacity and EER calculated according to EN 14511:2018

Performances in heating - Size 20.2

To	Tae (°C) DB/WB	Heating capacity EN14511								COP EN14511							
		Percentage of compressor load								Percentage of compressor load							
°C	°C	100%	90%	80%	70%	60%	50%	40%	min%	100%	90%	80%	70%	60%	50%	40%	min%
25	-10/-11.1	47,5	41,9	38,0	33,8	29,3	24,5	19,4	15,0	3,55	3,39	3,26	3,18	3,10	2,98	2,85	2,71
	-7/-8	50,1	44,8	41,1	36,9	32,3	27,3	21,8	17,1	3,71	3,59	3,49	3,44	3,38	3,28	3,16	3,05
	2/1.1	61,1	55,8	52,1	47,6	42,4	36,5	29,5	23,3	4,38	4,35	4,33	4,35	4,35	4,30	4,19	4,04
	7/6	68,2	62,8	59,0	54,2	48,5	41,9	34,0	26,9	4,81	4,84	4,85	4,92	4,96	4,92	4,82	4,67
	10/8.2	72,8	67,3	63,4	58,4	52,3	45,2	36,7	29,1	5,09	5,14	5,19	5,28	5,34	5,32	5,22	5,06
	18/14	85,7	79,7	75,4	69,8	62,8	54,4	44,2	34,8	5,81	5,97	6,11	6,30	6,45	6,48	6,42	6,26
30	-10/-11.1	46,1	40,8	37,0	32,9	28,5	23,9	18,9	14,6	3,22	3,08	2,97	2,90	2,83	2,73	2,60	2,46
	-7/-8	48,9	43,8	40,1	36,1	31,6	26,7	21,2	16,6	3,36	3,26	3,17	3,14	3,09	2,99	2,88	2,77
	2/1.1	60,2	55,0	51,3	46,9	41,7	35,8	28,9	22,7	3,95	3,93	3,91	3,94	3,95	3,89	3,79	3,65
	7/6	67,4	62,0	58,2	53,4	47,7	41,1	33,2	26,2	4,33	4,35	4,37	4,44	4,47	4,44	4,34	4,19
	10/8.2	72,1	66,5	62,5	57,5	51,5	44,4	35,9	28,3	4,57	4,62	4,67	4,75	4,81	4,79	4,69	4,53
	18/14	84,9	78,8	74,5	68,8	61,8	53,4	43,2	33,9	5,19	5,34	5,47	5,63	5,77	5,79	5,72	5,55
35	-10/-11.1	44,9	39,7	36,1	32,2	27,9	23,4	18,5	14,3	2,93	2,81	2,71	2,65	2,59	2,49	2,38	2,24
	-7/-8	47,9	42,9	39,3	35,4	30,9	26,1	20,8	16,2	3,05	2,97	2,90	2,86	2,82	2,74	2,63	2,52
	2/1.1	59,4	54,2	50,5	46,1	41,0	35,1	28,2	22,1	3,57	3,56	3,55	3,57	3,58	3,53	3,43	3,28
	7/6	66,7	61,3	57,4	52,6	46,9	40,3	32,5	25,4	3,90	4,00	4,01	4,03	4,04	4,01	3,91	3,75
	10/8.2	71,3	65,7	61,7	56,7	50,6	43,6	35,1	27,5	4,11	4,16	4,20	4,28	4,33	4,31	4,21	4,04
	18/14	84,1	77,9	73,5	67,8	60,7	52,3	42,1	32,9	4,65	4,78	4,89	5,04	5,15	5,17	5,09	4,91
40	-10/-11.1	43,7	38,8	35,3	31,5	27,4	23,0	18,2	14,1	2,66	2,56	2,48	2,43	2,37	2,29	2,19	2,06
	-7/-8	46,9	42,1	38,6	34,8	30,4	25,7	20,4	15,9	2,78	2,71	2,65	2,62	2,58	2,51	2,40	2,30
	2/1.1	58,6	53,5	49,8	45,4	40,3	34,5	27,7	21,5	3,25	3,24	3,23	3,25	3,26	3,21	3,11	2,95
	7/6	65,9	60,5	56,6	51,9	46,2	39,6	31,8	24,7	3,54	3,56	3,58	3,63	3,66	3,63	3,52	3,35
	10/8.2	70,5	64,9	60,9	55,8	49,8	42,7	34,3	26,7	3,71	3,76	3,79	3,87	3,91	3,89	3,78	3,60
	18/14	83,2	76,9	72,5	66,7	59,6	51,3	41,1	31,8	4,19	4,30	4,39	4,52	4,62	4,63	4,53	4,33
45	-10/-11.1	42,6	38,0	34,6	30,9	26,9	22,7	18,0	13,9	2,42	2,34	2,27	2,23	2,18	2,11	2,01	1,89
	-7/-8	45,9	41,3	38,0	34,2	29,9	25,3	20,1	15,7	2,53	2,47	2,42	2,40	2,37	2,30	2,20	2,09
	2/1.1	57,8	52,7	49,1	44,8	39,7	33,9	27,1	21,0	2,94	2,94	2,93	2,96	2,96	2,92	2,81	2,65
	7/6	66,7	61,3	57,4	51,1	45,4	38,8	31,1	24,0	3,21	3,23	3,25	3,28	3,31	3,27	3,16	2,99
	10/8.2	69,7	64,0	60,0	54,9	48,9	41,9	33,5	25,9	3,35	3,39	3,42	3,49	3,53	3,50	3,38	3,20
	18/14	82,1	75,8	71,3	65,5	58,4	50,1	39,9	30,7	3,75	3,85	3,94	4,05	4,13	4,12	4,01	3,80
50	-10/-11.1	-	-	-	-	-	-	-	-	-	-	-	-	-	-	-	-
	-7/-8	45,1	40,6	37,4	33,7	29,6	25,0	19,9	15,5	2,31	2,26	2,22	2,20	2,18	2,12	2,02	1,92
	2/1.1	57,0	52,0	48,4	44,1	39,1	33,4	26,5	20,5	2,67	2,67	2,67	2,69	2,70	2,65	2,54	2,39
	7/6	64,2	58,8	55,0	50,3	44,6	38,1	30,3	23,3	2,89	2,91	2,93	2,97	3,00	2,95	2,84	2,66
	10/8.2	68,7	63,1	59,0	54,0	48,0	41,0	32,6	25,0	3,02	3,06	3,09	3,15	3,18	3,15	3,03	2,84
	18/14	80,9	74,5	70,0	64,2	57,1	48,8	38,7	29,5	3,36	3,45	3,52	3,62	3,69	3,68	3,56	3,33
55	2/1.1	56,2	51,3	47,7	43,5	38,5	32,8	26,0	20,0	2,43	2,43	2,43	2,45	2,46	2,41	2,30	2,13
	7/6	63,3	58,0	54,1	49,4	43,8	37,3	29,6	22,6	2,61	2,63	2,65	2,69	2,71	2,67	2,55	2,37
	10/8.2	67,7	62,1	58,0	53,0	47,0	40,1	31,7	24,2	2,72	2,76	2,79	2,84	2,87	2,83	2,71	2,51
	18/14	79,4	73,1	68,5	62,8	55,7	47,5	37,4	28,3	3,00	3,08	3,15	3,24	3,30	3,27	3,14	2,91

To = Leaving internal exchanger water temperature (°C)

Tae [°C]= External exchanger inlet air temperature

Performances in function of the inlet/outlet water temperature differential = 5°C

Heating capacity and COP calculated according to EN 14511:2018

ATTENTION: The data of the heat capacity and COP include defrostings.

# General technical data

## Performances in cooling - Size 20.2

To	Tae	Cooling capacity EN14511								EER EN14511							
		Percentage of compressor load								Percentage of compressor load							
°C	°C	100%	90%	80%	70%	60%	50%	40%	min%	100%	90%	80%	70%	60%	50%	40%	min%
5	10	69,7	61,5	54,6	48,5	42,6	36,4	29,7	25,3	5,61	5,84	6,08	6,26	6,36	6,42	6,46	6,51
	15	66,8	59,0	52,4	46,5	40,8	34,7	28,2	24,0	4,82	5,02	5,23	5,39	5,48	5,53	5,53	5,55
	25	61,0	53,9	47,9	42,5	37,2	31,5	25,3	21,3	3,65	3,81	3,97	4,10	4,16	4,18	4,14	4,12
	35	55,0	48,7	43,3	38,3	33,4	28,1	22,3	18,6	2,77	2,89	3,02	3,11	3,15	3,13	3,04	2,97
	45	48,8	43,2	38,4	34,0	29,5	24,6	19,2	15,7	2,10	2,19	2,28	2,34	2,35	2,30	2,17	2,07
7	10	74,2	65,5	58,3	51,8	45,4	38,8	31,6	26,9	5,89	6,17	6,45	6,66	6,80	6,88	6,93	7,00
	15	71,2	62,9	55,9	49,7	43,5	37,0	30,0	25,5	5,06	5,30	5,55	5,73	5,85	5,90	5,91	5,94
	25	65,2	57,6	51,2	45,5	39,8	33,6	27,0	22,7	3,83	4,01	4,20	4,34	4,43	4,45	4,41	4,38
	35	58,8	52,1	46,3	41,1	35,8	30,1	23,8	19,8	2,90	3,05	3,19	3,29	3,34	3,32	3,22	3,15
	45	52,3	46,3	41,2	36,5	31,6	26,3	20,5	16,7	2,21	2,31	2,41	2,47	2,49	2,44	2,30	2,19
10	10	81,0	71,6	63,7	56,7	49,7	42,3	34,4	29,2	6,23	6,57	6,92	7,19	7,36	7,47	7,51	7,58
	15	78,0	69,0	61,4	54,6	47,8	40,6	32,9	27,8	5,42	5,71	6,02	6,26	6,42	6,50	6,54	6,60
	25	71,7	63,4	56,4	50,1	43,7	37,0	29,6	24,8	4,12	4,32	4,55	4,73	4,84	4,88	4,84	4,82
	35	64,8	57,4	51,1	45,3	39,4	33,1	26,1	21,6	3,12	3,28	3,45	3,57	3,63	3,62	3,52	3,44
	45	57,6	51,1	45,5	40,2	34,8	28,9	22,4	18,2	2,37	2,49	2,61	2,68	2,70	2,65	2,49	2,37
15	10	93,2	82,6	73,6	65,5	57,4	48,7	39,4	33,3	6,91	7,37	7,88	8,30	8,61	8,80	8,93	9,09
	15	90,0	79,7	71,0	63,1	55,2	46,8	37,7	31,7	6,03	6,42	6,85	7,20	7,46	7,63	7,71	7,81
	25	82,9	73,5	65,3	58,0	50,6	42,7	34,0	28,4	4,58	4,87	5,16	5,40	5,57	5,65	5,63	5,64
	35	75,1	66,6	59,3	52,6	45,7	38,2	30,0	24,8	3,48	3,68	3,90	4,06	4,15	4,16	4,04	3,96
	45	66,9	59,4	52,8	46,7	40,4	33,4	25,7	20,8	2,65	2,79	2,94	3,04	3,07	3,02	2,84	2,69
18	10	101	89,5	79,7	70,9	62,1	52,7	42,5	36,2	7,29	7,86	8,48	9,01	9,44	9,72	9,94	10,1
	15	97,4	86,4	77,0	68,4	59,8	50,7	40,7	34,6	6,38	6,85	7,36	7,80	8,15	8,38	8,54	8,58
	25	89,8	79,7	71,0	63,0	54,9	46,2	36,7	31,0	4,87	5,19	5,56	5,83	6,05	6,16	6,17	6,09
	35	81,5	72,3	64,4	57,0	49,6	41,4	32,4	27,0	3,70	3,93	4,18	4,37	4,49	4,51	4,40	4,23
	45	72,7	64,5	57,4	50,7	43,8	36,1	27,7	22,8	2,82	2,98	3,15	3,26	3,31	3,25	3,06	2,94
20	10	106	94,1	83,9	74,6	65,3	55,3	44,5	38,0	7,55	8,18	8,89	9,51	10,0	10,4	10,7	10,9
	15	102	90,9	81,0	72,0	63,0	53,2	42,7	36,2	6,61	7,13	7,71	8,22	8,62	8,92	9,15	9,22
	25	94,6	83,9	74,7	66,3	57,8	48,6	38,6	32,5	5,06	5,41	5,81	6,13	6,38	6,53	6,56	6,49
	35	85,8	76,2	67,8	60,1	52,2	43,5	34,1	28,3	3,85	4,10	4,37	4,58	4,72	4,75	4,64	4,48
	45	76,6	68,0	60,5	53,4	46,1	38,0	29,1	23,9	2,93	3,11	3,29	3,42	3,47	3,42	3,22	3,10

To = Leaving internal exchanger water temperature (°C)

Tae [°C]= External exchanger inlet air temperature

Performances in function of the inlet/outlet water temperature differential = 5°C

Cooling capacity and EER calculated according to EN 14511:2018

Performances in heating - Size 25.2

To	T <sub>ae</sub> (°C) DB/WB	Heating capacity EN14511								COP EN14511							
		Percentage of compressor load								Percentage of compressor load							
°C	°C	100%	90%	80%	70%	60%	50%	min%	40%	100%	90%	80%	70%	60%	50%	min%	40%
25	-10/-11.1	48,8	44,4	43,5	40,3	35,8	31,3	26,5	22,3	3,02	3,20	3,24	3,26	3,24	3,27	3,47	3,54
	-7/-8	54,4	49,0	47,9	44,2	39,2	34,1	28,7	23,9	3,35	3,55	3,60	3,62	3,59	3,60	3,81	3,86
	2/1.1	70,9	62,8	61,1	56,1	49,2	42,4	35,3	28,9	4,31	4,56	4,62	4,63	4,57	4,56	4,76	4,69
	7/6	80,0	70,6	68,7	63,0	55,2	47,4	39,3	32,0	4,83	5,11	5,19	5,20	5,12	5,09	5,31	5,20
	10/8.2	85,2	75,5	73,4	67,4	58,9	50,6	41,8	34,1	5,12	5,45	5,54	5,55	5,46	5,43	5,66	5,62
	18/14	100,1	88,7	86,3	79,2	69,3	59,4	49,0	39,8	5,88	6,36	6,48	6,53	6,47	6,46	6,75	6,61
30	-10/-11.1	49,4	44,2	43,1	39,8	35,2	30,6	25,7	21,5	2,77	2,95	3,00	3,02	3,00	3,02	3,20	3,25
	-7/-8	54,8	48,6	47,3	43,6	38,3	33,2	27,7	23,0	3,06	3,27	3,32	3,34	3,31	3,32	3,50	3,54
	2/1.1	70,7	61,9	60,1	55,0	48,0	41,2	34,0	27,6	3,92	4,17	4,24	4,26	4,20	4,18	4,36	4,28
	7/6	79,7	69,6	67,5	61,7	53,8	46,0	37,8	30,6	4,37	4,67	4,75	4,76	4,69	4,67	4,86	4,74
	10/8.2	84,7	74,3	72,1	65,9	57,4	49,0	40,3	32,6	4,62	4,96	5,06	5,08	5,01	4,98	5,18	5,12
	18/14	99,3	87,2	84,6	77,5	67,5	57,6	47,2	38,0	5,31	5,78	5,91	5,97	5,93	5,93	6,19	6,12
35	-10/-11.1	50,1	44,1	42,9	39,4	34,7	30,0	25,0	20,8	2,53	2,69	2,74	2,75	2,73	2,74	2,88	2,91
	-7/-8	55,2	48,4	47,0	43,1	37,7	32,4	26,9	22,2	2,80	2,98	3,03	3,04	3,01	3,00	3,15	3,15
	2/1.1	70,7	61,2	59,2	54,1	47,0	40,1	32,9	26,5	3,55	3,78	3,84	3,85	3,79	3,76	3,91	3,80
	7/6	79,3	68,6	65,3	60,6	52,6	44,7	36,6	29,4	3,96	4,22	4,29	4,31	4,24	4,20	4,35	4,21
	10/8.2	84,3	73,2	70,9	64,7	56,1	47,7	38,9	31,3	4,16	4,48	4,57	4,59	4,52	4,48	4,64	4,55
	18/14	98,6	85,9	83,2	76,0	66,0	56,0	45,7	36,6	4,76	5,21	5,33	5,39	5,34	5,33	5,54	5,45
40	-10/-11.1	50,8	44,2	42,8	39,2	34,3	29,5	24,5	20,2	2,32	2,45	2,49	2,49	2,46	2,45	2,56	2,56
	-7/-8	55,7	48,3	46,7	42,7	37,2	31,8	26,3	21,5	2,56	2,70	2,74	2,75	2,70	2,68	2,79	2,77
	2/1.1	70,7	60,7	58,6	53,4	46,2	39,2	32,1	25,6	3,23	3,41	3,46	3,46	3,39	3,35	3,45	3,31
	7/6	79,2	67,9	65,6	59,7	51,6	43,7	35,6	28,4	3,58	3,80	3,86	3,86	3,79	3,73	3,84	3,68
	10/8.2	83,9	72,4	70,0	63,7	55,1	46,6	37,9	30,2	3,77	4,03	4,10	4,12	4,03	3,98	4,09	3,98
	18/14	98,0	84,9	82,1	74,9	64,8	54,8	44,5	35,4	4,30	4,68	4,79	4,84	4,78	4,75	4,90	4,78
45	-10/-11.1	51,6	44,4	42,8	39,1	34,0	29,1	24,1	19,7	2,12	2,22	2,24	2,24	2,19	2,17	2,25	2,22
	-7/-8	56,4	48,3	46,6	42,5	36,8	31,4	25,8	21,0	2,33	2,44	2,47	2,46	2,41	2,37	2,44	2,40
	2/1.1	70,8	60,3	58,1	52,8	45,6	38,6	31,4	24,9	2,92	3,05	3,09	3,09	3,01	2,95	3,01	2,86
	7/6	79,1	67,4	64,9	59,0	50,8	42,9	34,8	27,6	3,33	3,39	3,44	3,44	3,35	3,28	3,35	3,17
	10/8.2	83,6	71,7	69,3	63,0	54,2	45,7	37,0	29,4	3,39	3,60	3,66	3,66	3,57	3,50	3,57	3,44
	18/14	97,4	84,0	81,2	73,9	63,8	53,8	43,5	34,4	3,84	4,17	4,26	4,29	4,22	4,17	4,28	4,13
50	-10/-11.1	-	-	-	-	-	-	-	-	-	-	-	-	-	-	-	-
	-7/-8	56,8	48,3	46,6	42,4	36,6	31,1	25,5	20,6	2,12	2,19	2,21	2,20	2,13	2,08	2,13	2,07
	2/1.1	70,8	60,0	57,8	52,5	45,2	38,1	30,9	24,4	2,64	2,73	2,76	2,74	2,65	2,58	2,62	2,47
	7/6	78,8	67,0	64,5	58,5	50,3	42,4	34,3	27,1	2,90	3,03	3,06	3,05	2,95	2,88	2,91	2,74
	10/8.2	83,4	71,3	68,7	62,4	53,7	45,2	36,4	28,8	3,04	3,20	3,25	3,24	3,15	3,07	3,11	2,92
	18/14	96,7	83,3	80,5	73,2	63,1	53,2	42,9	33,8	3,43	3,70	3,78	3,80	3,72	3,65	3,72	3,56
55	2/1.1	70,8	59,9	57,6	52,3	44,9	37,9	30,3	23,8	2,38	2,44	2,45	2,43	2,34	2,27	2,23	2,09
	7/6	78,6	66,7	64,2	58,3	50,0	42,1	33,9	26,8	2,59	2,69	2,72	2,70	2,60	2,52	2,53	2,36
	10/8.2	82,9	70,9	68,4	62,1	53,3	44,8	36,1	28,5	2,71	2,84	2,88	2,87	2,77	2,69	2,70	2,52
	18/14	92,5	82,1	79,9	72,8	62,7	52,8	42,5	33,4	3,13	3,30	3,34	3,35	3,27	3,19	3,24	3,07

To = Leaving internal exchanger water temperature (°C)

T<sub>ae</sub> [°C]= External exchanger inlet air temperature

Performances in function of the inlet/outlet water temperature differential = 5°C

Heating capacity and COP calculated according to EN 14511:2018

ATTENTION: The data of the heat capacity and COP include defrostings.

# General technical data

## Performances in cooling - Size 25.2

To	Tae	Cooling capacity EN14511								EER EN14511							
		Percentage of compressor load								Percentage of compressor load							
°C	°C	100%	90%	80%	70%	60%	50%	40%	min%	100%	90%	80%	70%	60%	50%	40%	min%
5	10	82,5	75,3	65,6	56,8	47,8	38,9	32,9	28,4	5,65	5,73	5,87	5,94	5,96	5,92	5,84	5,79
	15	79,8	72,7	63,3	54,6	45,9	37,2	31,3	26,9	4,97	5,06	5,22	5,31	5,36	5,36	5,31	5,28
	25	74,3	67,6	58,6	50,4	41,9	33,6	28,0	23,9	3,93	4,03	4,18	4,28	4,36	4,39	4,37	4,36
	35	68,7	62,4	53,9	46,0	38,0	30,0	24,8	20,9	3,02	3,08	3,19	3,25	3,27	3,25	3,19	3,15
	45	62,9	57,0	49,0	41,6	34,0	26,4	21,5	18,0	2,27	2,30	2,35	2,36	2,33	2,25	2,28	2,40
7	10	87,3	79,6	69,4	59,9	50,4	41,0	34,6	29,8	5,89	6,00	6,16	6,25	6,29	6,25	6,17	6,12
	15	84,4	76,9	66,9	57,7	48,4	39,1	32,9	28,3	5,20	5,31	5,48	5,58	5,65	5,65	5,60	5,56
	25	78,8	71,7	62,1	53,3	44,3	35,4	29,5	25,2	4,12	4,22	4,39	4,51	4,59	4,63	4,60	4,59
	35	72,4	66,2	57,2	48,8	40,2	31,7	26,2	22,1	3,15	3,24	3,35	3,42	3,46	3,43	3,36	3,32
	45	66,9	60,7	52,2	44,3	36,2	28,1	22,8	19,0	2,40	2,43	2,49	2,50	2,48	2,38	2,41	2,53
10	10	94,5	86,2	75,1	64,9	54,5	44,2	37,3	32,1	6,11	6,24	6,42	6,52	6,54	6,46	6,36	6,63
	15	91,7	83,6	72,6	62,6	52,4	42,3	35,5	30,4	5,54	5,68	5,89	6,03	6,11	6,12	6,07	6,03
	25	85,8	78,0	67,6	57,9	48,1	38,4	31,9	27,1	4,40	4,53	4,73	4,87	4,97	5,01	4,98	4,96
	35	79,6	72,3	62,4	53,2	43,9	34,5	28,4	23,9	3,41	3,49	3,63	3,71	3,75	3,73	3,65	3,60
	45	73,4	66,6	57,3	48,6	39,7	30,8	24,9	20,7	2,60	2,64	2,71	2,73	2,70	2,61	2,63	2,75
15	10	108	98,4	85,7	73,9	62,0	50,1	42,1	36,2	6,75	6,96	7,26	7,43	7,53	7,49	7,38	7,70
	15	105	95,6	83,0	71,5	59,7	48,0	40,2	34,4	6,14	6,36	6,66	6,87	7,02	7,07	7,02	6,99
	25	98,7	89,6	77,6	66,5	55,1	43,8	36,3	30,8	4,97	5,11	5,37	5,56	5,71	5,78	5,76	5,75
	35	92,0	83,6	72,1	61,5	50,6	39,7	32,6	27,4	3,86	3,98	4,15	4,27	4,33	4,32	4,25	4,19
	45	85,4	77,6	66,8	56,7	46,3	35,8	28,9	24,0	2,98	3,05	3,14	3,18	3,16	3,06	3,09	3,23
18	10	116	106	92,6	79,9	66,9	54,0	41,5	38,9	7,18	7,45	7,84	8,10	8,25	8,26	8,07	8,54
	15	113	103	89,9	77,3	64,5	51,8	39,4	37,0	6,55	6,81	7,21	7,49	7,69	7,80	7,72	7,74
	25	107	97,4	84,3	72,1	59,8	47,4	35,4	33,3	5,31	5,52	5,83	6,07	6,26	6,38	6,36	6,37
	35	98,2	89,2	78,7	67,1	55,1	43,2	31,7	29,8	4,15	4,18	4,36	4,46	4,52	4,63	4,55	4,53
	45	93,6	85,0	73,2	62,1	50,7	39,3	27,9	26,2	3,26	3,34	3,45	3,50	3,50	3,40	3,45	3,59
20	10	123	112	97,5	84,1	70,4	56,8	43,5	40,8	7,49	7,81	8,28	8,59	8,81	8,86	8,68	9,20
	15	120	109	94,7	81,5	67,9	54,5	41,4	38,9	6,85	7,16	7,61	7,95	8,22	8,36	8,32	8,34
	25	113	103	89,0	76,2	63,1	50,0	37,3	35,1	5,59	5,83	6,19	6,46	6,70	6,85	6,85	6,86
	35	106	96,6	83,4	71,0	58,4	45,8	33,5	31,5	4,43	4,60	4,83	5,00	5,11	5,13	4,99	5,00
	45	99,4	90,3	77,8	66,1	54,0	41,8	29,6	27,9	3,47	3,56	3,69	3,76	3,76	3,66	3,72	3,88

To = Leaving internal exchanger water temperature (°C)

Tae [°C]= External exchanger inlet air temperature

Performances in function of the inlet/outlet water temperature differential = 5°C

Cooling capacity and EER calculated according to EN 14511:2018

Performances in heating - Size 30.2

To	T <sub>ae</sub> (°C) DB/WB	Heating capacity EN14511								COP EN14511							
		Percentage of compressor load								Percentage of compressor load							
°C	°C	100%	90%	80%	70%	60%	50%	40%	min%	100%	90%	80%	70%	60%	50%	40%	min%
25	-10/-11.1	54,1	50,5	47,8	44,6	41,0	36,5	31,2	24,9	3,05	3,11	3,17	3,23	3,26	3,24	3,29	3,51
	-7/-8	60,0	56,0	52,8	49,2	45,0	40,0	33,9	26,8	3,37	3,45	3,52	3,59	3,62	3,59	3,63	3,85
	2/1.1	77,6	72,1	67,8	62,8	57,2	50,4	42,3	32,9	4,32	4,42	4,52	4,60	4,64	4,58	4,59	4,79
	7/6	87,3	81,1	76,4	70,7	64,3	56,5	47,2	36,5	4,81	4,95	5,07	5,17	5,21	5,13	5,13	5,33
	10/8.2	93,5	86,7	81,6	75,6	68,7	60,3	50,3	38,9	5,13	5,27	5,40	5,51	5,56	5,47	5,47	5,68
	18/14	109	101,7	95,8	88,8	80,8	71,0	59,2	45,5	5,90	6,10	6,28	6,44	6,53	6,48	6,51	6,78
30	-10/-11.1	54,5	50,7	47,7	44,3	40,5	35,9	30,4	24,1	2,79	2,86	2,92	2,98	3,02	3,00	3,04	3,23
	-7/-8	60,2	55,9	52,5	48,7	44,4	39,2	33,0	25,9	3,08	3,16	3,24	3,30	3,34	3,31	3,35	3,53
	2/1.1	77,2	71,4	67,0	61,9	56,1	49,2	41,0	31,6	3,91	4,03	4,13	4,22	4,26	4,20	4,21	4,38
	7/6	86,5	80,2	75,3	69,5	62,9	55,1	45,7	35,1	4,36	4,49	4,62	4,72	4,77	4,70	4,70	4,87
	10/8.2	92,5	85,7	80,4	74,3	67,2	58,8	48,8	37,3	4,63	4,77	4,91	5,03	5,08	5,02	5,02	5,19
	18/14	108	100,3	94,3	87,2	79,0	69,2	57,3	43,7	5,31	5,51	5,70	5,87	5,97	5,93	5,97	6,20
35	-10/-11.1	55,0	50,9	47,7	44,2	40,2	35,4	29,8	23,4	2,54	2,61	2,67	2,72	2,76	2,73	2,76	2,91
	-7/-8	60,4	55,9	52,4	48,4	43,9	38,6	32,3	25,1	2,80	2,88	2,95	3,01	3,04	3,01	3,03	3,17
	2/1.1	76,8	70,9	66,3	61,1	55,2	48,2	39,9	30,6	3,54	3,64	3,74	3,82	3,86	3,80	3,79	3,91
	7/6	85,9	79,4	74,4	68,5	61,8	53,9	44,5	33,9	3,98	4,17	4,23	4,27	4,31	4,25	4,23	4,35
	10/8.2	91,7	84,7	79,3	73,2	66,0	57,5	47,4	36,0	4,16	4,30	4,43	4,54	4,59	4,53	4,51	4,64
	18/14	107	99,2	93,0	85,8	77,6	67,7	55,8	42,2	4,81	4,97	5,13	5,29	5,39	5,35	5,37	5,55
40	-10/-11.1	55,6	51,2	47,9	44,1	40,0	35,1	29,4	22,9	2,32	2,37	2,43	2,48	2,50	2,46	2,47	2,57
	-7/-8	60,8	56,0	52,3	48,2	43,5	38,1	31,7	24,5	2,55	2,61	2,68	2,73	2,75	2,71	2,70	2,80
	2/1.1	76,6	70,5	65,8	60,5	54,5	47,4	39,1	29,7	3,20	3,29	3,38	3,44	3,47	3,40	3,37	3,45
	7/6	85,5	78,8	73,7	67,7	61,0	52,9	43,5	32,9	3,54	3,65	3,76	3,84	3,87	3,80	3,76	3,83
	10/8.2	91,1	84,0	78,5	72,3	65,1	56,5	46,4	34,9	3,75	3,87	3,99	4,08	4,12	4,05	4,01	4,08
	18/14	106	98,1	91,9	84,7	76,4	66,4	54,6	41,0	4,28	4,45	4,61	4,75	4,84	4,79	4,78	4,89
45	-10/-11.1	56,2	51,6	48,1	44,2	39,9	34,9	29,0	22,4	2,10	2,15	2,20	2,24	2,25	2,20	2,18	2,25
	-7/-8	61,2	56,2	52,4	48,1	43,3	37,8	31,3	24,0	2,31	2,36	2,42	2,46	2,47	2,41	2,39	2,44
	2/1.1	76,5	70,2	65,4	60,0	53,9	46,8	38,4	29,0	2,88	2,95	3,03	3,08	3,09	3,02	2,97	3,00
	7/6	85,0	78,3	73,1	67,1	60,3	52,2	42,7	32,1	3,29	3,34	3,39	3,43	3,45	3,36	3,31	3,33
	10/8.2	90,6	83,4	77,9	71,5	64,3	55,7	45,5	34,1	3,35	3,46	3,56	3,64	3,67	3,58	3,53	3,55
	18/14	105	97,2	91,0	83,8	75,5	65,5	53,6	40,1	3,82	3,97	4,11	4,23	4,30	4,24	4,20	4,26
50	-10/-11.1	-	-	-	-	-	-	-	-	-	-	-	-	-	-	-	-
	-7/-8	61,6	56,5	52,5	48,1	43,2	37,6	31,0	23,6	2,09	2,13	2,18	2,21	2,21	2,14	2,10	2,12
	2/1.1	76,4	70,1	65,2	59,7	53,6	46,4	37,9	28,2	2,58	2,65	2,71	2,75	2,75	2,67	2,60	2,54
	7/6	84,7	77,9	72,7	66,6	59,8	51,7	42,2	31,5	2,84	2,92	3,00	3,05	3,06	2,97	2,90	2,88
	10/8.2	90,1	82,9	77,3	70,9	63,8	55,1	45,0	33,5	2,99	3,08	3,17	3,23	3,25	3,16	3,09	3,08
	18/14	105	96,5	90,3	83,1	74,8	64,8	52,9	39,4	3,39	3,52	3,65	3,75	3,80	3,73	3,68	3,69
55	2/1.1	77,3	70,4	65,1	59,6	53,4	45,6	37,7	27,4	2,34	2,38	2,42	2,45	2,44	2,33	2,28	2,16
	7/6	85,6	78,1	72,4	66,4	59,5	50,8	41,9	31,0	2,57	2,62	2,67	2,71	2,71	2,59	2,54	2,44
	10/8.2	90,6	82,9	76,9	70,6	63,4	54,1	44,6	33,2	2,73	2,78	2,82	2,87	2,88	2,75	2,70	2,67
	18/14	104	95,6	89,0	82,5	74,3	63,6	52,5	39,0	3,14	3,20	3,26	3,32	3,35	3,24	3,22	3,20

To = Leaving internal exchanger water temperature (°C)

T<sub>ae</sub> [°C]= External exchanger inlet air temperature

Performances in function of the inlet/outlet water temperature differential = 5°C

Heating capacity and COP calculated according to EN 14511:2018

ATTENTION: The data of the heat capacity and COP include defrostings.

# General technical data

## Performances in cooling - Size 30.2

To	Tae	Cooling capacity EN14511								EER EN14511							
		Percentage of compressor load								Percentage of compressor load							
°C	°C	100%	90%	80%	70%	60%	50%	40%	30%	100%	90%	80%	70%	60%	50%	40%	30%
5	10	88,7	80,9	72,5	62,5	52,3	43,1	33,2	29,2	5,57	5,64	5,77	5,89	5,95	5,94	5,85	5,81
	15	85,8	78,2	70,0	60,3	50,3	41,3	31,5	27,7	4,89	4,98	5,11	5,24	5,34	5,36	5,32	5,29
	25	80,0	72,8	65,0	55,8	46,2	37,6	28,2	24,7	3,85	3,94	4,07	4,21	4,33	4,38	4,38	4,36
	35	74,0	67,2	59,9	51,1	42,0	33,8	24,8	21,6	2,96	3,02	3,11	3,21	3,27	3,27	3,19	3,16
	45	67,7	61,5	54,7	46,4	37,8	30,0	21,5	18,6	2,24	2,27	2,32	2,36	2,35	2,30	2,35	2,38
7	10	93,8	85,5	76,6	66,1	55,2	45,5	34,9	30,7	5,80	5,90	6,04	6,20	6,27	6,27	6,16	6,13
	15	90,8	82,7	74,0	63,7	53,1	43,5	33,1	29,1	5,10	5,21	5,35	5,52	5,62	5,65	5,60	5,57
	25	84,8	77,1	68,9	59,0	48,8	39,7	29,6	25,9	4,03	4,13	4,27	4,43	4,56	4,61	4,61	4,59
	35	78,4	71,4	63,6	54,3	44,5	35,8	26,2	22,8	3,10	3,17	3,27	3,38	3,45	3,45	3,36	3,33
	45	72,1	65,5	58,2	49,4	40,2	32,0	22,8	19,7	2,36	2,40	2,45	2,50	2,50	2,44	2,49	2,51
10	10	102	92,6	83,0	71,5	59,7	49,1	37,5	33,0	6,00	6,12	6,29	6,46	6,54	6,51	6,36	6,30
	15	98,6	89,8	80,4	69,1	57,5	47,1	35,7	31,3	5,42	5,55	5,74	5,93	6,08	6,12	6,07	6,04
	25	92,3	84,0	75,0	64,2	53,0	43,0	32,0	28,0	4,30	4,42	4,59	4,77	4,92	5,00	4,99	4,97
	35	85,7	77,9	69,5	59,2	48,6	39,0	28,4	24,7	3,33	3,42	3,53	3,65	3,74	3,75	3,65	3,61
	45	79,0	71,8	63,9	54,3	44,2	35,0	24,8	21,4	2,55	2,60	2,66	2,72	2,73	2,66	2,71	2,73
15	10	116	106	94,7	81,6	68,0	55,8	42,4	37,2	6,57	6,78	7,05	7,32	7,49	7,52	7,38	7,31
	15	113	103	91,9	79,0	65,6	53,6	40,4	35,4	5,97	6,18	6,44	6,73	6,96	7,06	7,03	7,00
	25	106	96,5	86,2	73,7	60,8	49,2	36,4	31,8	4,80	4,97	5,18	5,43	5,64	5,76	5,78	5,76
	35	99,0	90,1	80,3	68,4	56,1	44,9	32,6	28,3	3,77	3,88	4,03	4,19	4,31	4,34	4,25	4,20
	45	91,9	83,6	74,5	63,3	51,5	40,8	28,8	24,8	2,92	2,99	3,08	3,15	3,18	3,12	3,18	3,20
18	10	125	114	102	88,2	73,4	60,1	45,6	39,0	6,95	7,23	7,56	7,93	8,18	8,28	8,16	8,06
	15	122	111	99,5	85,5	70,9	57,9	43,5	37,1	6,34	6,60	6,93	7,30	7,60	7,76	7,77	7,72
	25	115	105	93,6	80,1	66,0	53,3	39,4	33,4	5,14	5,35	5,61	5,91	6,17	6,33	6,38	6,35
	35	108	95,1	87,6	74,7	61,1	49,0	35,5	29,8	4,02	4,10	4,29	4,46	4,65	4,78	4,70	4,62
	45	101	91,6	81,6	69,4	56,5	44,8	31,6	26,2	3,19	3,27	3,37	3,47	3,51	3,46	3,54	3,44
20	10	132	120	108	92,8	77,2	63,2	47,9	41,0	7,23	7,56	7,94	8,38	8,71	8,86	8,78	8,67
	15	128	117	105	90,1	74,7	60,9	45,7	39,0	6,61	6,92	7,29	7,72	8,09	8,30	8,36	8,31
	25	121	111	98,9	84,6	69,7	56,3	41,5	35,1	5,40	5,63	5,93	6,28	6,58	6,78	6,87	6,84
	35	114	104	92,8	79,1	64,8	51,8	37,5	31,5	4,30	4,46	4,66	4,89	5,06	5,13	5,06	4,98
	45	107	97,3	86,8	73,8	60,1	47,6	33,6	27,9	3,39	3,49	3,60	3,72	3,77	3,72	3,82	3,71

To = Leaving internal exchanger water temperature (°C)

Tae [°C]= External exchanger inlet air temperature

Performances in function of the inlet/outlet water temperature differential = 5°C

Cooling capacity and EER calculated according to EN 14511:2018

Performances in heating - Size 35.2

To	Tae (°C) DB/WB	Heating capacity EN14511								COP EN14511							
		Percentage of compressor load								Percentage of compressor load							
°C	°C	100%	90%	80%	70%	60%	50%	40%	min%	100%	90%	80%	70%	60%	50%	40%	min%
25	-10/-11.1	58,6	54,2	50,2	46,8	43,2	38,5	32,8	26,7	3,01	3,07	3,14	3,20	3,25	3,27	3,19	3,46
	-7/-8	65,1	60,1	55,6	51,7	47,6	42,3	35,8	28,8	3,33	3,40	3,48	3,55	3,61	3,62	3,52	3,79
	2/1.1	84,4	77,7	71,6	66,3	60,7	53,4	44,7	35,5	4,24	4,34	4,47	4,56	4,63	4,63	4,46	4,75
	7/6	95,0	87,4	80,6	74,6	68,2	60,0	50,0	39,5	4,72	4,85	5,00	5,11	5,20	5,19	4,99	5,29
	10/8.2	102	93,5	86,2	79,7	73,0	64,1	53,3	42,0	5,02	5,16	5,32	5,44	5,55	5,54	5,33	5,64
	18/14	119	110	101	93,7	85,8	75,4	62,7	49,3	5,77	5,96	6,17	6,35	6,50	6,54	6,33	6,73
30	-10/-11.1	59,2	54,5	50,3	46,7	42,9	38,0	32,1	25,9	2,74	2,81	2,89	2,95	3,00	3,02	2,94	3,19
	-7/-8	65,4	60,2	55,5	51,3	47,0	41,5	34,9	27,9	3,03	3,11	3,19	3,26	3,33	3,34	3,25	3,49
	2/1.1	84,0	77,1	70,9	65,4	59,6	52,3	43,4	34,2	3,83	3,94	4,07	4,16	4,25	4,25	4,09	4,35
	7/6	94,2	86,6	79,6	73,5	67,0	58,6	48,5	38,0	4,26	4,39	4,54	4,66	4,75	4,76	4,58	4,84
	10/8.2	101	92,5	85,0	78,5	71,6	62,6	51,7	40,5	4,52	4,66	4,83	4,95	5,07	5,08	4,88	5,16
	18/14	118	108	99,7	92,2	84,1	73,7	60,9	47,5	5,18	5,37	5,59	5,77	5,93	5,99	5,80	6,17
35	-10/-11.1	59,9	55,0	50,5	46,6	42,6	37,6	31,5	25,2	2,49	2,56	2,63	2,69	2,74	2,75	2,67	2,87
	-7/-8	65,9	60,4	55,4	51,1	46,6	41,0	34,2	27,1	2,75	2,82	2,91	2,97	3,03	3,04	2,94	3,14
	2/1.1	83,7	76,7	70,3	64,7	58,8	51,3	42,4	33,1	3,46	3,56	3,68	3,77	3,85	3,85	3,69	3,90
	7/6	93,7	87,7	80,8	74,6	68,0	57,5	47,3	36,8	3,98	4,15	4,26	4,37	4,40	4,40	4,23	4,36
	10/8.2	99,9	91,6	84,1	77,4	70,4	61,3	50,4	39,1	4,06	4,19	4,35	4,47	4,58	4,58	4,39	4,62
	18/14	118	108	98,4	90,8	82,7	72,2	59,3	45,9	4,79	4,90	5,02	5,19	5,35	5,40	5,23	5,52
40	-10/-11.1	60,6	55,5	50,8	46,7	42,5	37,3	31,0	24,6	2,27	2,33	2,40	2,45	2,49	2,49	2,40	2,55
	-7/-8	66,3	60,7	55,5	51,0	46,4	40,5	33,6	26,5	2,50	2,56	2,64	2,70	2,74	2,74	2,63	2,78
	2/1.1	83,6	76,4	69,9	64,2	58,1	50,5	41,5	32,3	3,13	3,22	3,33	3,40	3,46	3,45	3,29	3,44
	7/6	93,3	85,3	78,1	71,9	65,1	56,5	46,3	35,8	3,45	3,56	3,69	3,79	3,86	3,85	3,67	3,83
	10/8.2	99,3	90,9	83,3	76,6	69,5	60,3	49,3	38,1	3,65	3,77	3,92	4,02	4,11	4,10	3,91	4,08
	18/14	116	106	97,4	89,8	81,6	71,0	58,1	44,7	4,16	4,32	4,51	4,67	4,81	4,84	4,66	4,88
45	-10/-11.1	61,5	56,0	51,1	46,9	42,5	37,1	30,7	24,2	2,06	2,12	2,17	2,21	2,25	2,23	2,13	2,24
	-7/-8	66,9	61,0	55,7	51,0	46,2	40,2	33,2	26,0	2,26	2,32	2,39	2,43	2,47	2,45	2,33	2,43
	2/1.1	83,5	76,2	69,6	63,8	57,7	50,0	40,8	31,6	2,81	2,89	2,99	3,05	3,10	3,07	2,90	3,00
	7/6	91,2	84,9	77,6	71,3	64,5	55,8	45,5	35,0	3,25	3,29	3,34	3,39	3,45	3,42	3,23	3,34
	10/8.2	98,7	90,3	82,7	75,9	68,8	59,5	48,5	37,2	3,26	3,37	3,50	3,59	3,66	3,64	3,44	3,56
	18/14	115	105	96,5	88,8	80,6	70,0	57,1	43,8	3,70	3,85	4,02	4,16	4,27	4,29	4,10	4,26
50	-10/-11.1	-	-	-	-	-	-	-	-	-	-	-	-	-	-	-	-
	-7/-8	67,5	61,4	55,9	51,1	46,2	40,1	32,9	25,6	2,05	2,10	2,15	2,19	2,21	2,18	2,05	2,12
	2/1.1	83,5	76,1	69,4	63,5	57,3	49,6	40,4	31,1	2,52	2,59	2,68	2,73	2,76	2,72	2,55	2,61
	7/6	92,6	84,5	77,2	70,8	64,0	55,3	45,0	34,4	2,77	2,85	2,95	3,02	3,06	3,02	2,84	2,90
	10/8.2	98,2	89,8	82,2	75,4	68,2	59,0	47,9	36,6	2,91	3,01	3,12	3,20	3,25	3,22	3,02	3,10
	18/14	114	104	95,7	88,1	79,9	69,3	56,4	43,1	3,28	3,41	3,57	3,69	3,79	3,79	3,60	3,71
55	2/1.1	83,4	76,0	69,3	63,4	57,2	49,4	40,1	30,5	2,26	2,32	2,39	2,43	2,46	2,41	2,24	2,22
	7/6	92,6	84,4	76,9	70,5	63,7	55,0	44,7	34,1	2,53	2,58	2,63	2,69	2,72	2,67	2,49	2,52
	10/8.2	98,7	89,7	81,5	75,0	67,8	58,6	47,6	36,3	2,70	2,74	2,78	2,84	2,88	2,84	2,65	2,69
	18/14	116	104	93,7	86,8	79,4	68,8	56,0	42,7	3,16	3,18	3,20	3,29	3,34	3,33	3,15	3,22

To = Leaving internal exchanger water temperature (°C)

Tae [°C]= External exchanger inlet air temperature

Performances in function of the inlet/outlet water temperature differential = 5°C

Heating capacity and COP calculated according to EN 14511:2018

ATTENTION: The data of the heat capacity and COP include defrostings.



# General technical data

## Performances in cooling - Size 35.2

To	Tae	Cooling capacity EN14511								EER EN14511							
		Percentage of compressor load								Percentage of compressor load							
°C	°C	100%	90%	80%	70%	60%	50%	40%	30%	100%	90%	80%	70%	60%	50%	40%	30%
5	10	96,4	87,9	77,2	68,5	58,9	47,7	36,7	30,8	5,32	5,51	5,67	5,83	5,95	5,95	5,89	5,82
	15	93,2	85,0	74,6	66,1	56,7	45,7	35,0	29,2	4,66	4,84	5,00	5,18	5,32	5,36	5,34	5,30
	25	87,0	79,3	69,5	61,3	52,3	41,8	31,5	26,1	3,66	3,82	3,97	4,14	4,29	4,36	4,39	4,37
	35	80,4	73,3	64,1	56,4	47,8	37,9	28,0	22,9	2,81	2,93	3,04	3,16	3,25	3,27	3,23	3,17
	45	73,6	67,1	58,6	51,4	43,3	33,9	24,5	19,8	2,14	2,21	2,28	2,34	2,37	2,33	2,20	2,33
7	10	102	93,0	81,6	72,4	62,2	50,3	38,6	32,3	5,53	5,74	5,93	6,13	6,26	6,28	6,21	6,14
	15	98,6	90,0	79,0	69,9	59,9	48,3	36,8	30,7	4,85	5,05	5,24	5,44	5,59	5,65	5,63	5,58
	25	92,1	84,0	73,6	64,9	55,3	44,2	33,2	27,4	3,82	3,99	4,16	4,35	4,51	4,59	4,62	4,60
	35	85,3	77,8	68,0	59,9	50,7	40,1	29,6	24,2	2,91	3,07	3,20	3,33	3,43	3,45	3,40	3,34
	45	78,3	71,4	62,4	54,7	46,1	36,1	26,1	21,0	2,25	2,33	2,41	2,48	2,51	2,47	2,34	2,46
10	10	110	101	88,5	78,4	67,3	54,3	41,7	34,8	5,69	5,94	6,16	6,38	6,53	6,54	6,43	6,33
	15	107	97,7	85,8	75,9	65,0	52,2	39,8	33,1	5,13	5,37	5,59	5,83	6,03	6,11	6,10	6,05
	25	100	91,4	80,1	70,7	60,2	48,0	35,9	29,6	4,07	4,26	4,46	4,67	4,86	4,97	5,00	4,97
	35	93,1	84,9	74,3	65,4	55,4	43,7	32,2	26,2	3,16	3,30	3,44	3,59	3,71	3,75	3,70	3,63
	45	85,7	78,3	68,5	60,1	50,6	39,6	28,5	22,9	2,43	2,52	2,61	2,69	2,74	2,70	2,56	2,69
15	10	126	115	101	89,5	76,7	61,8	47,2	39,3	6,19	6,52	6,85	7,19	7,45	7,53	7,45	7,34
	15	122	112	98,1	86,8	74,2	59,5	45,1	37,4	5,61	5,92	6,25	6,58	6,87	7,02	7,06	7,01
	25	115	105	92,0	81,2	69,1	54,9	41,0	33,7	4,51	4,76	5,02	5,30	5,56	5,71	5,78	5,76
	35	107	98,1	85,9	75,6	64,0	50,5	37,0	30,1	3,55	3,73	3,92	4,11	4,27	4,33	4,29	4,22
	45	99,7	91,1	79,7	70,0	59,0	46,1	33,2	26,5	2,77	2,89	3,01	3,12	3,19	3,16	3,01	3,15
18	10	136	124	109	96,7	82,9	66,7	50,8	42,3	6,51	6,91	7,31	7,74	8,09	8,25	8,23	8,12
	15	132	121	106	93,9	80,3	64,3	48,6	40,3	5,93	6,30	6,68	7,10	7,47	7,69	7,78	7,75
	25	125	114	100	88,2	75,0	59,6	44,4	36,4	4,82	5,11	5,43	5,75	6,06	6,26	6,37	6,37
	35	117	107	93,7	82,4	69,8	55,0	40,3	32,7	3,83	4,04	4,26	4,48	4,68	4,77	4,75	4,67
	45	109	99,7	87,4	76,7	64,7	50,6	36,4	29,1	3,02	3,16	3,29	3,43	3,51	3,49	3,34	3,51
20	10	143	131	115	101,7	87,2	70,2	53,4	44,4	6,74	7,18	7,66	8,14	8,58	8,81	8,84	8,74
	15	139	127	112	99,0	84,6	67,8	51,2	42,4	6,17	6,57	7,01	7,49	7,93	8,21	8,36	8,34
	25	132	120	106	93,2	79,2	62,9	46,8	38,4	5,05	5,36	5,71	6,09	6,44	6,69	6,85	6,86
	35	124	113	99,2	87,3	73,9	58,2	42,6	34,6	4,04	4,27	4,51	4,77	4,99	5,11	5,10	5,03
	45	116	106	92,8	81,6	68,8	53,8	38,8	30,9	3,21	3,36	3,51	3,66	3,76	3,76	3,60	3,78

To = Leaving internal exchanger water temperature (°C)

Tae [°C]= External exchanger inlet air temperature

Performances in function of the inlet/outlet water temperature differential = 5°C

Cooling capacity and EER calculated according to EN 14511:2018

## Domestic hot water management in the modular system

It is possible to connect up to 16 units on a local network, reaching a maximum power of 1360 kW and up to 4 units connected hydraulically. The combinations can also occur with units with different power. The modular system, obtained by combining multiple modules, preserves the strengths of the individual module, but it multiplies the advantages:

- **Increasing system efficiency:**  
the operation of multiple units connect in parallel increases total seasonal efficiency by 3%.
- **Greater reliability:**  
The redundancy of cooling circuits and compressors guarantees full operation even in case of malfunction of a single module, that can be repaired while the system continues to be in operation.
- **Handling and simplified installation:**  
the compact dimensions of an individual module make it easy to pass through doors and elevators. The V design of the coils makes it possible to reduce side clear space. The quick connections allow simple and quick installation.
- **Easy and quick maintenance:**  
all of the main components can be reached from the front guaranteeing on-line maintenance of a module, without blocking the adjacent modules. Every unit is equipped with cutoff and non return valve in order to isolate the individual unit in case of malfunction.
- **Scalability:**  
it is possible to add additional modules, even subsequently, in order to satisfy system load requirements that may have changed

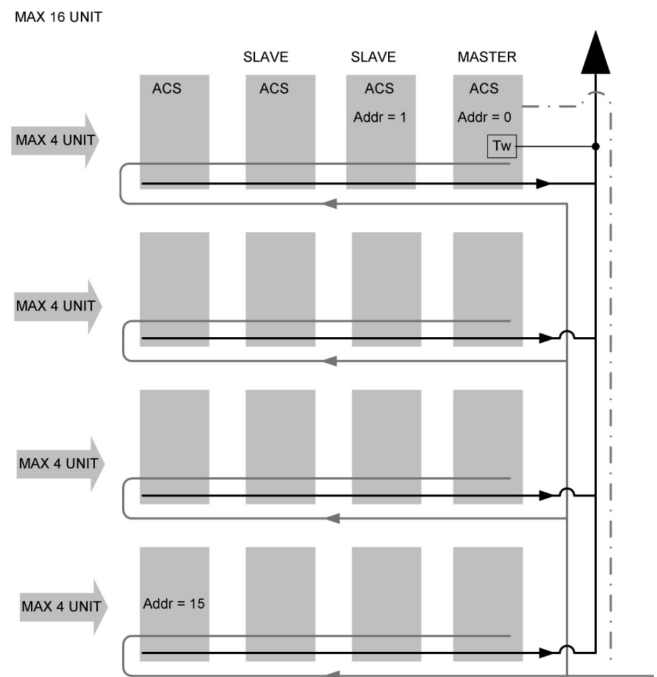

Modular system connection diagram - addressing



## Domestic hot water management in the modular system

Every module of the system can produce domestic hot water.

- It is necessary for each module dedicated to producing DHW to be equipped with 3-way valve installed on board (3DHW).
- Every module must have its own circulation pump and its own domestic hot water storage (responsibility of the Customer).
- The 3-way valve mounted on board presents a leakage equal to the following ratio:  $0.015 \leq K_{vo} K_{vs}$  ( $K_{vs} = 45$ )
- The DHW pumping unit will be managed directly by the unit dedicated to DHW using a free contact.
- DHW production only takes place if the DHW storage temperature is above a minimum threshold. The minimum temperature threshold varies based on the external temperature. In order to avoid that it falls under the minimum temperature, it is best to install a backup electric heater on the DHW storage.

t outdoor	t5 (ACS storage)	compr.	backup heater
$24^{\circ}\text{C} < t.o \leq 30^{\circ}\text{C}$	$< 15^{\circ}\text{C}$	OFF	ON
$24^{\circ}\text{C} < t.o \leq 30^{\circ}\text{C}$	$\geq 15^{\circ}\text{C}$	ON	OFF
$t.o > 30^{\circ}\text{C}$	$< 20^{\circ}\text{C}$	OFF	ON
$t.o > 30^{\circ}\text{C}$	$\geq 20^{\circ}\text{C}$	ON	OFF

Domestic hot water management is of priority compared to the system.

### If the system is satisfied (unit off):

When the temperature probe (T5), supplied by Clivet and positioned inside the storage calls for production of DHW, the unit dedicated to DHW activates, changing the set-point from set system to set DHW and diverts the water flow through the built-in 3-way valve. The unit will remain active until the DHW set-point has been satisfied, then it will shut-off.

### If the system has a request (unit is on):

When the temperature probe (T5) sends a request for production of DHW, the unit dedicated to DHW, which is already active for the system stops, the cycle changes and if producing cooled water, the set-point changes from set system to set DHW and diverts the water flow through the built-in 3-way valve. The unit will remain active until the DHW set-point has been satisfied, then it will return to producing the system.

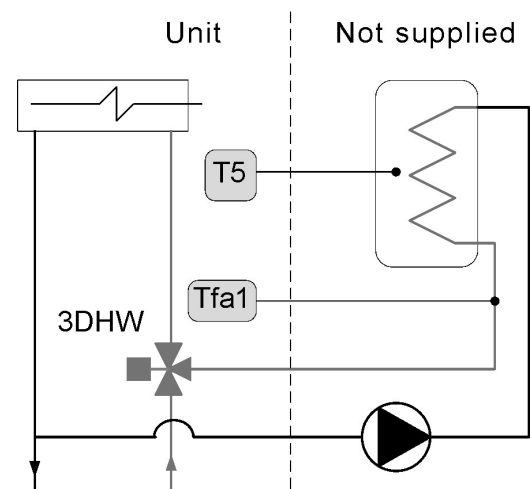

Connection diagram for connecting the individual module for producing domestic hot water

## Modular system configuration

- Management of the entire system takes place through a unit defined as master. The master unit controller can be set up remotely at a maximum distance of up to 300 m.
- All units must be connected to each other using a shielded cable with three wires (3 x 0.75 mm<sup>2</sup>).
- Each module must be configured with the water connections for modular unit (AMODX).
- Each module can be equipped with inertial system storage tank (ACIMP).
- It's possible to select a built-in hydronic group
- It's possible to have an external pumping group, sized for the entire capacity of the modular system (responsibility of the Customer). Pumping unit management will take place from the Master unit through a potential free contact and 0-10V signal.
- It is necessary to install a Y filter on the water input of the entire modular system (customer responsibility) with the following characteristics: MESH equal to 30 (0.5 mm)

Every module is identified by a specific address.

Complete system management is carried out by the master unit, identified by the address 0.

Thermoregulation takes place on the supply temperature of the entire defined system (Tw)

**If  $T_w \geq \text{set point} + 10^\circ\text{C}$ :**

the regulation activates 50% of the resources in sequence based on the defined address. Once a time interval has passed (default: 240 seconds), if the load increases, further resources are activated, if the load decreases, the units are shutoff with the sequence (first start, first stop).

**If  $T_w < \text{set point} + 10^\circ\text{C}$ :**

The adjustment on activates the master unit. Once a time interval has passed (default: 240 seconds), if the load increases, in sequence further resources will activate based on the defined address, if the load decreases the master unit will shut-off.

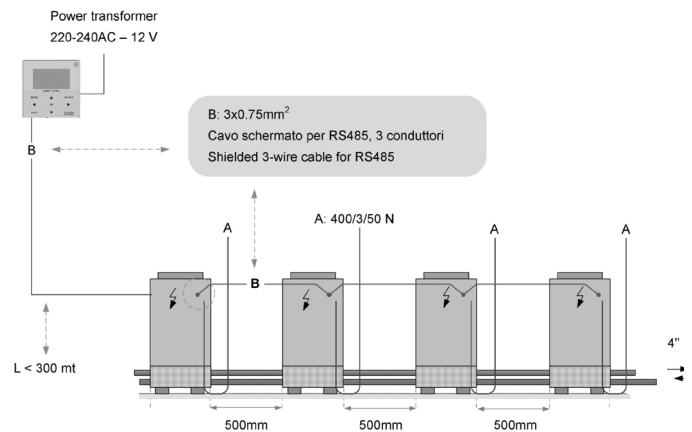

Modular system connection diagram

- Clearance values
- Power supply
- Connection

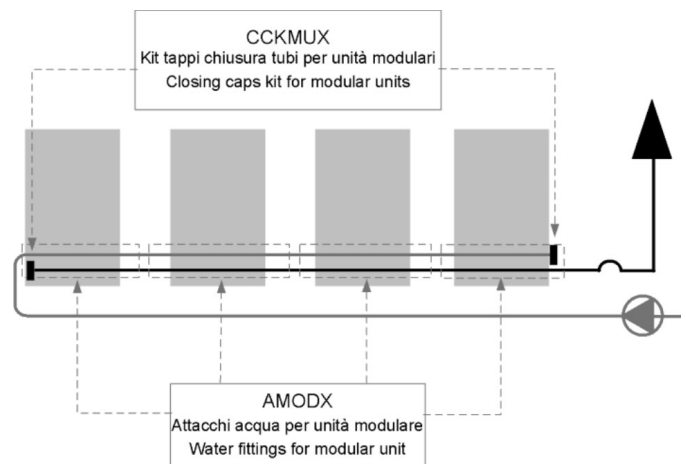

Options for modular system connection:

- AMODX - Water fitting for modular unit
- CCKMUX - Closing caps kit

# Dimensional drawings

## Size 18.2 - 20.2

DAAST0001\_REV00  
Data/Date 10/04/2019

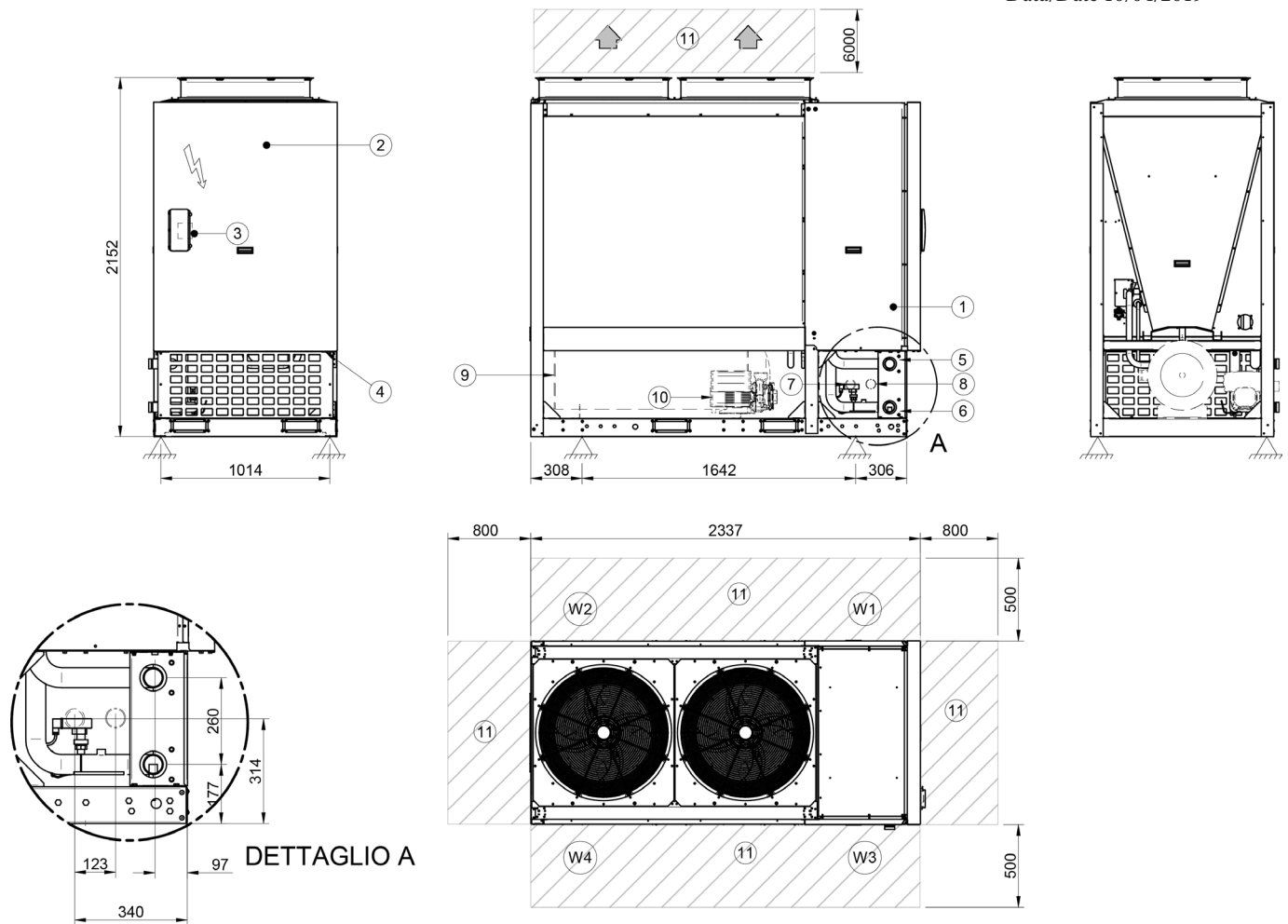

1. Compressor compartment
2. Electrical panel
3. Control keypad
4. Power input
5. Water inlet 2" Victaulic
6. Water outlet 2" Victaulic
7. DWH inlet 2" Victaulic (optional)
8. DWH outlet 2" Victaulic (optional)
9. Water tank (optional)
10. Pump (optional)
11. Functional spaces

In modular configuration the water input and output are 4" Victaulic.

Size			18.2	20.2
Lenght	mm		2337	2337
Depth	mm		1130	1130
Height	mm		2152	2152
Operating weight	kg		580	580
Shipping weight	kg		590	590

The presence of optional accessories may result in a substantial variation of the weights shown in the table.

## Size 25.2 - 30.2 - 35.2

DAAST0002\_REV00  
Data/Date 10/04/2019

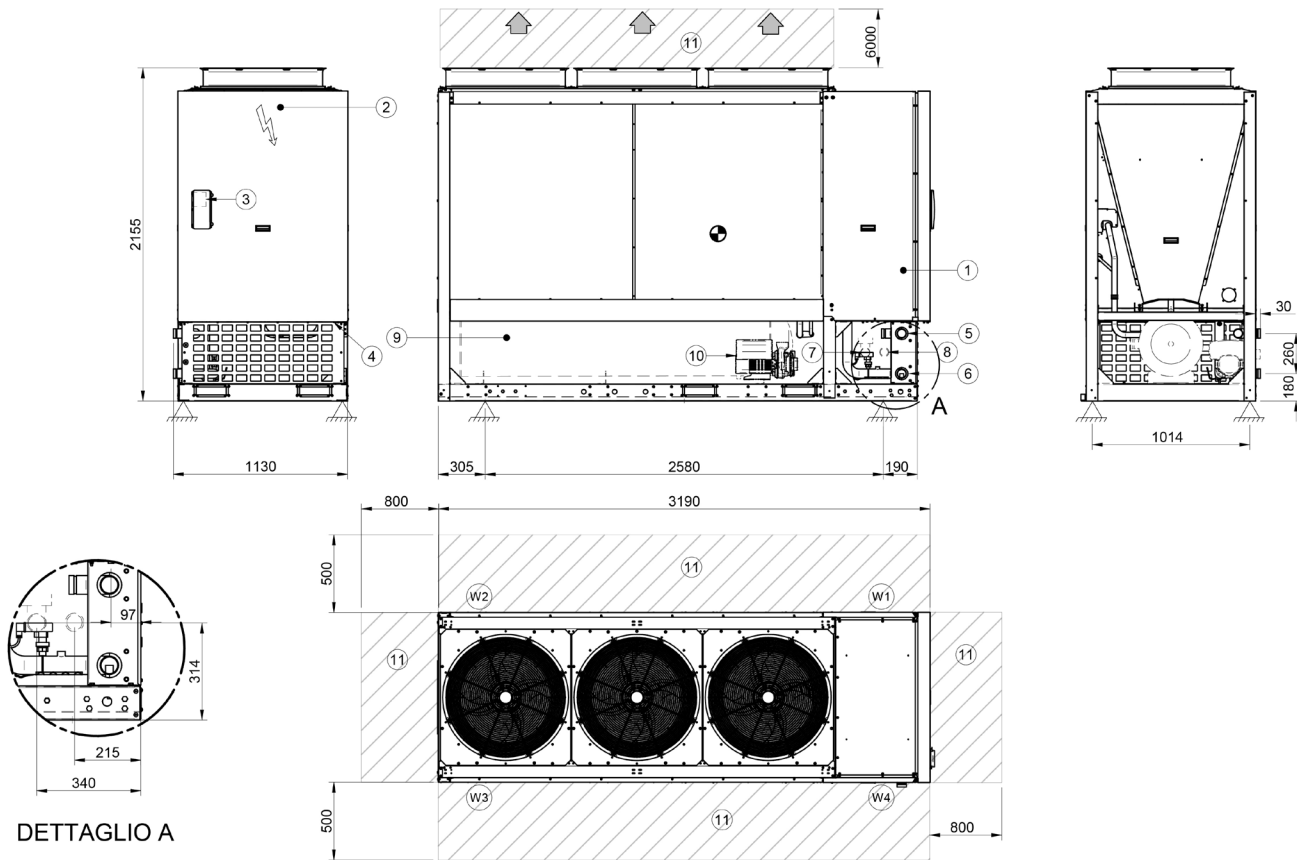

1. Compressor compartment
2. Electrical panel
3. Control keypad
4. Power input
5. Water inlet 2" Victaulic
6. Water outlet 2" Victaulic
7. DWH inlet 2" Victaulic (optional)
8. DWH outlet 2" Victaulic (optional)
9. Water tank (optional)
10. Pump (optional)
11. Functional spaces

In modular configuration the water input and output are 4" Victaulic.

Size			25.2	30.2	35.2
Lenght	mm		3190	3190	3190
Depth	mm		1130	1130	1130
Height	mm		2155	2155	2155
Operating weight	kg		780	780	780
Shipping weight	kg		796	796	796

The presence of optional accessories may result in a substantial variation of the weights shown in the table.

Page intentionally left blank

FOR OVER 30 YEARS WE HAVE BEEN  
OFFERING SOLUTIONS TO ENSURE  
SUSTAINABLE COMFORT AND THE WELL-  
BEING OF PEOPLE AND THE ENVIRONMENT

[www.clivet.com](http://www.clivet.com)

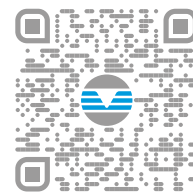

sales and assistance

ELFOenergy STORM - BT19G012GB-01



**CLIVET SPA**

Via Camp Lonc 25, Z.I. Villapaiera

32032 Feltre (BL) - Italy

Tel. +39 0439 3131 - Fax +39 0439 313300

[info@clivet.it](mailto:info@clivet.it)

A Group Company of

