

SPINchiller³

Water-cooled liquid chiller
for indoor installation

WSH-XSC3 70.4-240.4 RANGE

Nominal cooling capacity from 218 kW to 733 kW
Nominal heating capacity from 249 kW to 845 kW

- ▶ R-410A modular scroll technology
- ▶ Two independent refrigeration circuits
- ▶ Partial recovery of the condensing heat
- ▶ Pre-assembled control unit
- ▶ Application versatility
- ▶ High efficiency at partial loads, ESEER up to 6,1



Index of contents

Features and benefits	4
Standard unit technical specifications	16
System solutions.....	18
Unit configuration.....	19
General technical data - Performance	21
General technical data - Construction.....	22
Sound level	23
Operating range - Cooling	24
Operating range - Heating.....	24
Admissible water flow-rates	25
Correction factors for glycol use	25
Fouling Correction Factors.....	25
Overload and control device calibrations	25
Cooling and heating side pressure drop	26
Cooling performance.....	27
Heating performance	29
Cooling performance at part loads.....	31
Configurations.....	33
Efficient use of energy with heat recovery.....	34
Heating side hydronic assemblies.....	35
Cooling side hydronic assemblies.....	42
Accessories	49
Accessories separately supplied.....	53
Option compatibility.....	56
Dimensional drawings.....	58

Clivet hydronic system

Designed to provide high energy efficiency and sustainability of the investment, the wide range of Clivet liquid chillers and heat pumps for high efficiency air conditioning of Residential and Commercial spaces and for Industrial applications it is available with air or water source.

HYDRONIC System - Water Source

	Small and Medium Commercial		Large Commercial and Industry		
	ELFOEnergy Ground	ELFOEnergy Ground Medium*	SPINChiller ³ Water / SPINsaver Multi Scroll Technology		SCREWLine ³
Capacities (ABS/W)	6 ÷ 35 kW	30 ÷ 360 kW	200 ÷ 750 kW	750 ÷ 5250 kW	325 ÷ 1610 kW
ErP compliance (heat pumps only)					
Products					
Chillers	WSH-EE	WSH-XEE2	WSH-XSC3	WSH-XSC3	WDH-SL3 (DCO)
Heat pumps with inversion on the water circuit	WSH-EE (OH)	WSH-XEE2	WSH-XSC3	WSH-XSC3	WDH-SL3 (OH)
Heat pumps with inversion on the refrigeration circuit	WSHN-EE	WSHN-XEE2	WSHN-XSC3	WSHN-XSC3	
Multi-function heat pump		WSHN-XEE2 MF	WSHN-XSC3 MF	WSHN-XSC3 MF	
Evaporating units	ME	MSE-XEE2	MSE-XSC3		MDF-SL3

Specialization

Every intended use has specific requirements which determine the overall efficiency. For this, the Clivet hydronic system always offers the best solution in every project.

- Modular range with over 8000 kW of overall capacity
- Capacity control with Screw and modular Scroll technology
- Multifunction versions
- Outdoor or indoor (ductable type) installation

Centrality of the Air Renewal

From the Air Renewal depends the comfort in the spaces. Since it often represents the main building energetic load, it also determines the running costs of the entire system.



ZEPHIR3
Packaged Primary Air supply system with thermodynamic energy recovery.

- Simplifies the system, reduces the heating and cooling generators
- Purifies the air with standard electronic filters
- Increases the energy efficiency and it also allows a savings of 40% on the running costs
- From -40°C to +50°C of outdoor air temperature

Terminal and AHU complete system

The hydronic terminal units are very diffused for their versatility and reliability. The Clivet range includes many versions that simplify the application in different types of installation and building.

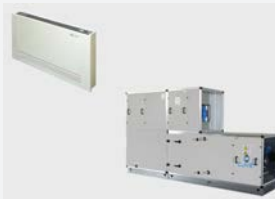

ELFOspace
High energy efficiency hydronic terminal units

AQX
Air-conditioning unit

- Cased and uncased terminal units, from 1 to 90 kW
- Horizontal and vertical installation
- Energy-saving DC fans
- Modular air conditioning units up to 160.000 m³/h
- EUROVENT certification

SPINchiller³: modular scroll technology for every application

SPINchiller³ is the new generation of Clivet liquid chillers and heat pump with modular scroll technology. Thanks to its high seasonal efficiency and range versatility, it represents the ideal solution for different types of installation.

WSH-XSC3

Water-cooled liquid chiller

- Available the reversible cooling and heating only version on the water circuit
- Partial recovery of the condensing heat
- Eurovent certification



WSHN-XSC3

Water-cooled heat pump

- Partial recovery of the condensing heat
- Eurovent certification



Dedicated series separately documented

WSHN-XSC3 Multifunction

Water-cooled heat/cool heat pump with simultaneous operating

- 4-pipe system
- 2-pipe system and total condensing heat recovery



Dedicated series separately documented

Cost or reliability?

The dilemma of modern system engineering applications

Air-conditioning systems in trade centres influence both the starting investment and monthly management costs, for the whole of their working lives. This theme is even more relevant in residential applications with centralised systems. Furthermore, maximum working flexibility requirements should be added to that, in serving different users while avoiding wasting energy and thus, money. Finally, there are several industrial applications which require hot or chilled water as service fluid, process fluid or vector fluid for operator comfort and for conserving goods and enabling cycles to function correctly. Furthermore, in all these cases, the working reliability of the system is decisive.



High efficiency hydronic systems

The high efficiency hydronic systems are extremely versatile, reliable and widespread

Despite their apparently low costs, split, multi-split and VRF direct expansion systems have a lot of limits in these applications. For example, they require a separate system for primary air treatment. The pipes that contain the refrigerant cross the served rooms and therefore they are subject to restrictions and use limitations. They cannot operate in the FREE-COOLING mode, the high efficiency and convenient mode that allows energy savings.

The hydronic systems are certainly more complete and versatile. They make it possible to adopt various types of terminals in the served environment, from fan coil units exposed or integrated in the furnishings, up to radiant or induction systems. They are also irreplaceable in the service and process industrial applications.

The main component performances, like air-cooled liquid chillers and hydronic heat pumps, are checked and certificated by appropriate certification programs, as Eurovent.



Clivet technological evolution

Clivet chillers reduce consumption and are compact and reliable

With over twenty years of technological evolution, Clivet liquid chillers and heat pumps represent the state of the art in air-conditioning of residential, trade and industrial environments.

Their success is based on high energy efficiency, compactness and management maintenance simplicity, with wide versatility in the choice of the most suitable model for the specific use.



SPINchiller³

Provides all Clivet technological developments for their medium capacity hydronic systems

High efficiency Scroll compressors, high performance heat exchangers, fully automatic operation: these are only some of the technologies available with SPINchiller³, in a range of models that are ideal for high capacity air conditioning systems in commercial, residential and industrial buildings.

The best combination between the initial investment and the costs throughout the entire life cycle of the system.

- It stands out for its extremely high energy efficiency under part load conditions.

SPINchiller³ can also be supplied in many configurations equipped with the main components installed built-in.



Advantages

High efficiency all year round

SPINchiller³ reduces yearly energy consumption thanks to its high part-load efficiency i.e., by far the most frequent condition throughout the system's life-cycle. This way, even the value of the served building increases. The main components are manufactured on an industrial scale, with maximum manufacturing reliability and can be easily found as spare parts.

To further increase energy efficiency in a system with several SPINchiller³ units operating on the same equipment, there is the innovative ECOSHARE feature, which automatically distributes the load and activates the necessary pumps.

System simplification

All of the features are provided by Clivet already assembled and tested built-in, differently than other manufacturers who make numerous additional components available to be installed on site.

Compact and versatile

Suitable for any type of terminals, from fan coils to radiant systems and chilled beams, SPINchiller³ is also available in Super-silenced configuration. Energy recovery for producing hot water free of charge, ECOSHARE management devices.

6.1

ESEER
Seasonal
Efficiency

Borderless multiscroll technology

With SPINchiller³ the modular scroll compressor technology reaches the best levels of performance and versatility ever, guaranteeing competitiveness in more and more demanding applications. The top class seasonal efficiency rewards SPINchiller³ in comparison to several other water cooled chiller technologies. A comparison with one SPINchiller³ competitor as:

- water cooled liquid chillers with inverter screw compressors;

shows that SPINchiller³ is the best solution, considering its seasonal efficiency comparable to the screw compressor chillers considering the capital investment pay back, that are always above acceptable values normally considered for system investment equal to 3 years.

Comfort and energy saving in one solution

Maximum efficiency is necessary with a part load

The system is required to generate maximum capacity only for a short amount of time.

Therefore, it is essential to have the maximum efficiency under part-load conditions.

This is the only way to actually reduce overall yearly consumptions.

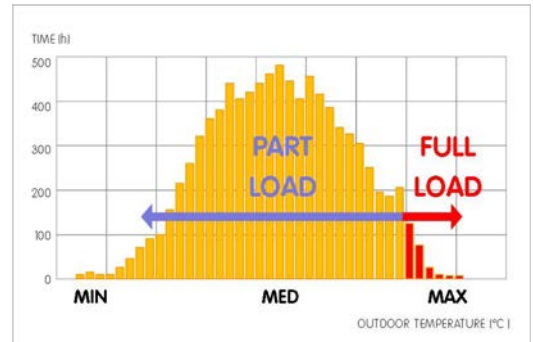

Part load efficiency determines the seasonal efficiency

Seasonal efficiency is conventionally represented by ESEER parameters according to Eurovent and IPLV parameters according to ARI. Both give great importance to part load operation, since it is the predominant condition.

SYSTEM LOAD	WEIGHT (ESEER) *	WEIGHT (IPLV) *
100%	3%	1%
75%	33%	42%
50%	41%	45%
25%	23%	12%

* EUROVENT (ESEER) supply times reference and ARI (IPLV) reference for seasonal efficiency calculations.

SPINchiller³ technology enhances part-load efficiency

SPINchiller³ uses high efficiency Scroll compressors.

The advantages are:

- compressors manufactured in large ranges on an industrial scale with strict quality control inspections and maximum manufacturing reliability thanks to the high production volumes.
- every refrigeration circuit uses two or three Scroll compressors, depending on the different sizes of the unit. When two compressors are used, their sizes are different in order to obtain more control steps. This way, only the necessary energy is supplied.

Doubled efficiency

The heat exchange surface is sized for full capacity operation. Under part load condition, some compressors are automatically deactivated. Under this condition, in fact, the compressors in operation make use of a much larger surface.

This entails a reduced condensation temperature and an increased evaporation temperature. This way, the compressor capacity consumption is reduced with respect to the yield thereby increasing the overall efficiency of the unit.

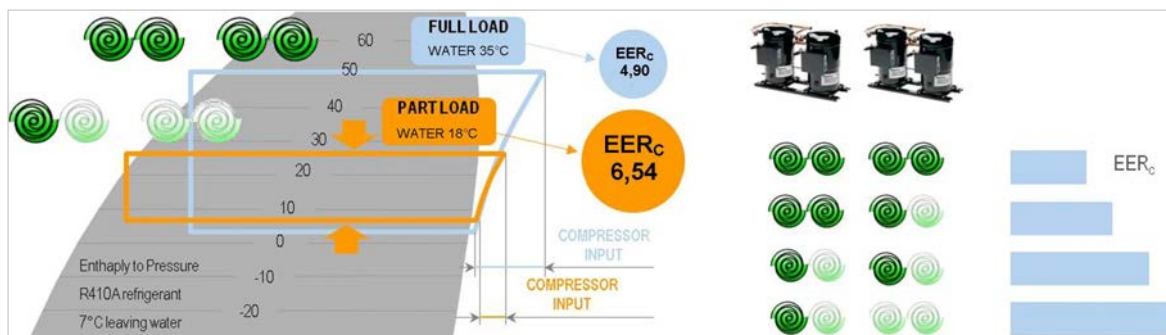

EERc = Energy efficiency referred to compressors

Two acoustic configurations available

Business oriented

All SPINchiller³ models feature high part-load energy efficiency, which means high ESEER seasonal efficiency.

The two configurations available allow choosing the best combination between the initial investment and the silence level.

Basic acoustic configuration

The Basic acoustic configuration (BN), thanks to the technological evolution of Clivet, is characterized by an extremely high seasonal efficiency. It, however, addresses to the most sensitive realizations to the initial investment, offering a simplified structure.

The structure is without panelling and the water connections must be carried out inside the unit (provided by the Customer).



Super-silenced acoustic configuration

The Super-silenced acoustic configuration (EN), in addition to the extremely high seasonal efficiency, stands out for a reduced sound pressure up to 8 dB(A).

The structure is equipped with soundproof panels and water connections only flush to the unit.

The dimensions are the same of the Basic version.



Perfect for LEED certification

All sizes from 70.4 to 200.4 fulfil both prerequisite 2 (Minimum Energy Performance) and 3 (Fundamental Refrigerant Management) of the Environment and Energy thematic area. They also fulfil the parameters of Credit 4 (Enhanced Refrigerant Management) which allows to get 1 point.

Clivet is committed in promoting the green building principles and has become a member of GBC Italia, the organization which collaborates with USGBC, the U.S. nonprofit organization that promotes worldwide the LEED system of independent certification.



Superior flexibility and reliability

Efficient precision

Sequential activation of SPINchiller³ compressors allow:

- adapting to the load required for use, thereby ensuring added comfort
- reducing the number of compressor start-ups, i.e., the main cause of wear
- increasing the unit's useful life
- reducing repair times and costs, thanks to the modular components, their reduced dimensions and reduced cost compared to semi-hermetic compressors.

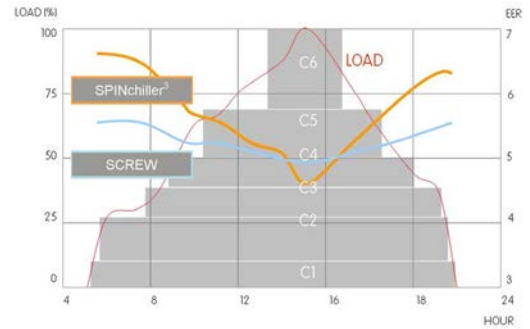

THE NUMBER OF START-UPS DECREASES THEREFORE THE LIFE CYCLE INCREASES

Stable and reliable operation

The electronic expansion valve (EEV) adapts rapidly and precisely to the actual load required for usage, allowing stable and reliable adjustment in comparison with mechanical thermostatic valves (TEV). This results also in a further increase in efficiency and longer compressor life.

The overheating control allows preventing phenomena that are hazardous to the compressors, such as overtemperature and return fluids, thereby increasing even more efficiency and durability.

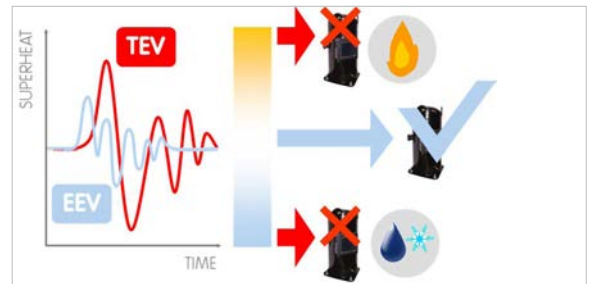

Simplified maintenance

Besides being efficient, SPINchiller³ improves the system maintenance.

In fact, the malfunction of a compressor does not compromise overall operation.

Furthermore, Scroll compressors are very compact, easy to find and easy to handle in case of replacement.



Controlled power supply

Proper power supply ensures optimal unit operation and protects its many electrical components.

The phase monitor, standard supplied.

- controls the presence and the exact sequence of the phases
- checks any voltage anomalies (-10%)
- automatically restarts the unit as soon as the proper power supply is restored.

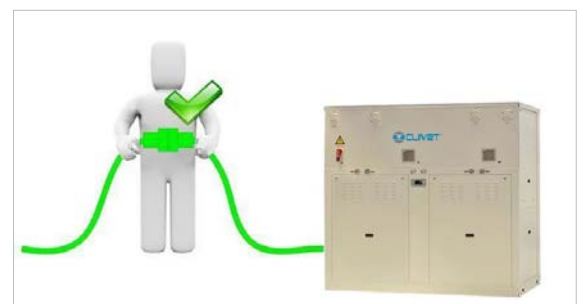

The automatic control device coordinates resources ensuring maximum efficiency

Advanced control

The control system combines in a single solution the operating efficiency and the user-friendliness. Continuously monitoring all of the unit operating parameters, it ensures the maintenance of an optimal energy efficiency. The control includes many safety functions and a complete alarm management.

It also includes advanced functions, such as daily and weekly programming and automatic maximum power consumption limitation (demand limit).

The interface terminal has a backlit graphic display and a multifunction access keypad. The multilevel menu is protected by different passwords according to the type of user.



Remote control (optional)

The remote control allows accessing to the same functions that are accessible by the built-in unit user interface, and can be installed at a maximum distance of 350 meters.



Modularity

In the event of particularly large buildings requiring high capacities, it is advisable to use several units.

The SPINchiller³ units are designed to be connected in parallel in modular logic, thereby granting the following advantages:

Increased flexibility, enhanced by the control that can adapt to the load

Increased reliability, since the malfunction of one unit does not compromise the capacity supply of the other units.

Increased efficiency, since energy is produced where and when required, according to the served area.

The microprocessor control combined with ECOSHARE allows controlling up to 7 units in local network (1 Master unit and 6 Slave).

MODULAR SYSTEM THAT ENHANCES SPINchiller³ TECHNOLOGY ADVANTAGES

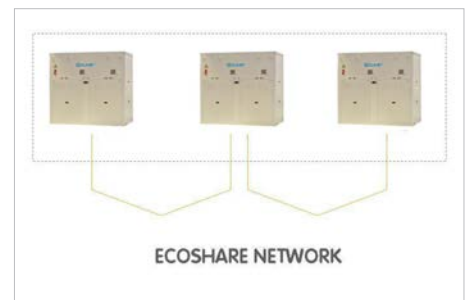

Remote system management

SPINchiller³ is standard equipped with:

- potential-free contact for remote on/off control
- potential-free contacts for remote display of the compressor status
- setting from user interface: Off / local On / serial On
- potential-free contact to remote any possible alarm

The various communication protocols allow the unit to exchange information with the main supervision systems by means of serial connections.



Energy measuring

Monitoring energy consumption and instant power employed is the starting point to improve the system's energy management and efficiency. With the optional energy meter, the user displays all the information related to the unit's electrical parameters on the interface built-in the unit or via the serial connection.

Moreover, the integration with the Demand Limit function supplied as standard allows to act on consumption levels by limiting them if they exceed the expected limit.



Seasonal energy efficiency is further increased with the DST operating logic

SPINchiller³ is equipped with standard DST control (Dynamic Supply Temperature) control logic, which can be activated by the user.

Unlike the traditional control logic that aims at maintaining the water supply temperature constant, the DST logic aims at keeping constant the water return temperature, modifying the supply temperature dynamically according to the load. This way, evaporation temperature increases during part-load cooling, thereby increasing seasonal energy efficiency.

The DST control allows a considerable consumption and operation costs reduction, especially in civil applications, upon verification of the air treatment system's dehumidification capacity during cooling at part load.

The DST control allows considerable consumption and operation costs reduction, especially in civil applications, upon verification of the air treatment system's dehumidification capacity during part-load cooling. The DST control is particularly interesting when combined with active thermodynamic fresh air systems. The direct expansion circuit allows them to operate the outdoor air treatment independently from SPINchiller³, which can vary the system water supply temperature, thereby optimising energy efficiency in the yearly cycle.

The DST control logic is as an alternative to the control logic at variable flow-rate.

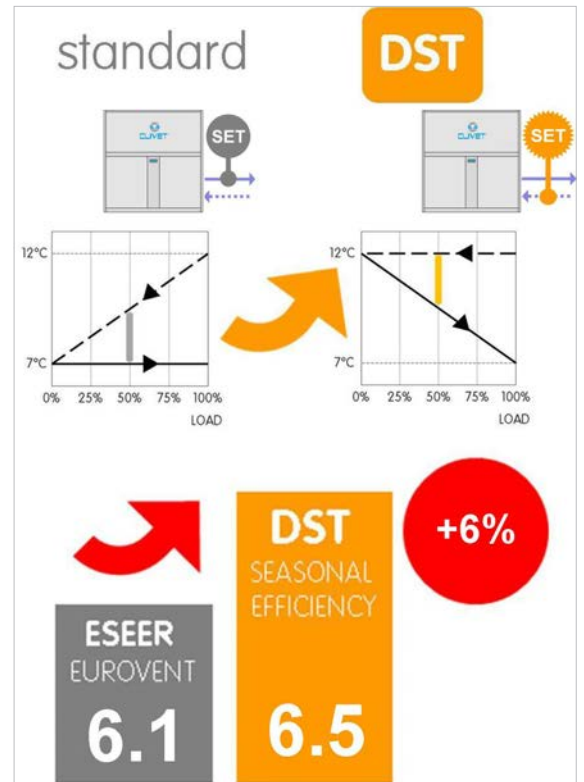

Example

The following diagram represents the various operating temperatures in the production of chilled water under various load conditions for a typical civil system consisting of:

- primary circuit with constant water flow rate
- secondary circuit with variable water flow-rate according to the load (linear variability for simplicity).

The traditional control logic keeps the water supply temperature to room terminals and outdoor air treatment units constant, in order for the latter to carry out the dehumidification.

The DST control logic, on the other hand, allows increasing the system water supply temperature during part-load operation, thereby increasing seasonal energy efficiency for SPINchiller³.

The DST application must be verified during the design stage according to specific system constraints.

Traditional control logic (system water flow rate temperature = constant)

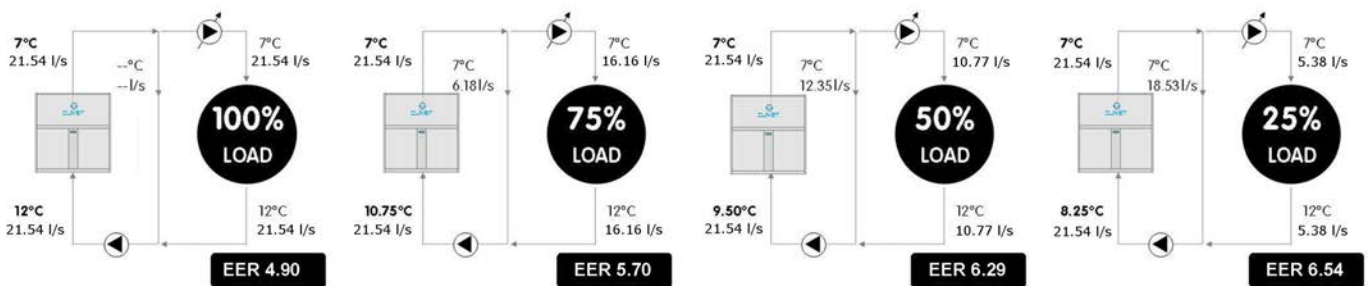

DST control logic (system water return temperature = constant)



SPINchiller³ technology industrialised the system

Pre-assembled unit

SPINchiller³ can be supplied equipped with components that are often provided separately.

- **Reduces design times:** all accessories have been selected to assure outstanding seasonal efficiency.
- **Reduces installation costs:** the accessories are already connected mechanically and electronically wired up, are controlled by a single controller and tested to be ready for immediate use.
- **Reduces overall dimensions:** when the heating or cooling capacity demand is very high, is possible to place side by side several units, considerably reducing the overall footprint and freeing up space for other equipment while facilitating maintenance.

Water flow-rate continuous modulation

SPINchiller³ enables adoption of both **source and user side hydronic assemblies**.

- The **VARYFLOW+ modulating pumping unit** made up of two pumps in parallel **controlled by inverter**, allows a precise water flow-rate modulation reducing notably the consumptions. When the system water temperature is critical, the VARYFLOW+ controls the condensation/evaporation temperature by extending the operating range of SPINchiller³.
- The **HYDROPACK pumping unit**, made up of two pumps in parallel, reduces the water flow-rate under critical conditions, avoiding blocks for overload and consequent interventions of specialized technical personnel. It is very useful during start-ups, at restart after operating breaks (ex. weekend) or after a long period of inactivity.

Both the pumping units guarantee its functionality also in case of temporary unavailability of one of the two pumps, **guaranteeing about the 80% of the nominal flow-rate**. In this situation **the unit performance changes only of 2%**.

In case of particular installation needs, the hydronic assemblies are also available:

- **ON/OFF pump** the traditional solution with high available pressure.
- **ON/OFF pump + ON/OFF pump in stand-by** the solution that favours reliability. The built-in control balances the operating hours of the two pumps and in case of any failure it signals the damage and automatically activates the stand-by pump.
- **2-way or 3-way modulating valves source side** with electronic control, extend the unit's operating range by modulating the source water flow in relation to temperature.
- **2-way modulating valve source side for high DP** the solution that adapts itself to the requirements of systems with high pressures (from 2 up to 3,5 bar).

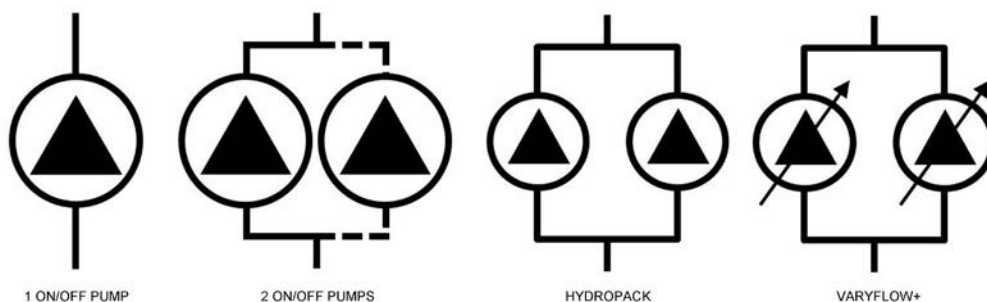

Variable flow-rate advantages

Pumping energy for moving the water has an heavy impact on seasonal efficiency. The variable flow control is available for all units and drives to energy savings during partial load. Pump energy consumption is proportional with cubic rotation speed. Evident the advantage when reducing flow-rate of 40% comparing to nominal conditions: energy saving is of 75% on pump energy consumption.

The control logic is based on keeping stable the water temperature entering and leaving difference, guaranteeing at the same time the best efficiency and a working envelope within an acceptable range for the heat exchanger (pressure losses).

The control logic applies to both flow-rate and compressor regulation thanks to steps. Proportional-Integral-Derivative guarantees a precise and stable operation.

The possibility of independent pump management in case of failure is embedded in the unit keeping operative the system.

Produces hot water freely

Condensation heat recovery:

- partial: it recovers about the 25% of the available heat (desuperheater)

It allows the free DHW production for:

- hot water coil supply for reheat
- domestic hot water production (with intermediate exchanger)
- other processes or operations

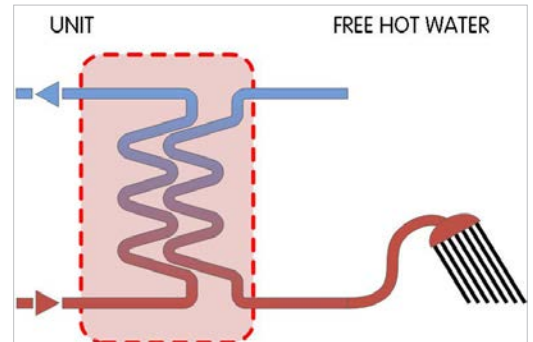

Even for low water temperature

The unit is also perfectly adapted for use in process cooling where the low temperature version (Brine) together with the addition of glycol to the thermo-vector liquid produces chilled water down to -8°C .

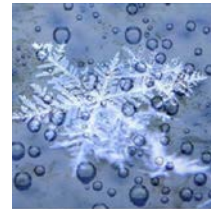

Further considerations on the installation

The vast operating field of SPINchiller³ allows it to adapt to most system applications. In some cases, special duty conditions may exceed the unit operating field. Simple devices on the system allow proper operation and meeting any requirement. Here are two examples.

Water flow rate values outside the limits

SPINchiller³ operates with constant water flow rate to the evaporator, between a minimum and maximum value indicated in the technical documents.

Flow rate values below the limit may cause unwanted formation of ice, incrustations, reduced control precision, and the unit to stop following the intervention of built-in safety devices.

Flow values above the limit may cause high pressure drops, high pumping costs, and reduced control precision, and erosion damages to the exchangers.

In this example, the required flow-rate is lower than the minimum value allowed to the evaporator, while the operating temperatures fall within the functional field of the unit.

A properly sized bypass piping resolves the problem.

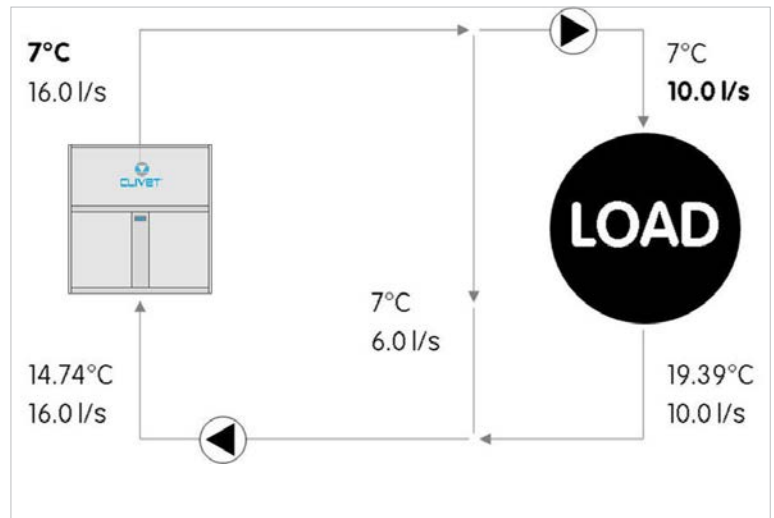

Example referred to WSH-XSC3 160.4.
Appropriate water flow rate for the correct unit operation.

Temperature values outside the limits

SPINchiller³ operates with the system supply temperatures indicated in the technical documentation.

Temperature limits below the limit may cause unwanted formation of ice and the unit to stop following the intervention of built-in safety devices.

Temperature values under the limit may cause malfunctions and damages to the compressors, reduced control precision, and the unit to stop following the intervention of built-in safety devices.

In this example, the required temperature exceeds the maximum value allowed to the evaporator, while the water flow rate falls within the functional field of the unit.

A properly sized bypass piping and mixing system resolve the problem.

Should both the water flow rate and the operating temperature exceed the values intended for the chiller, all you have to do is combine the two cases described above.

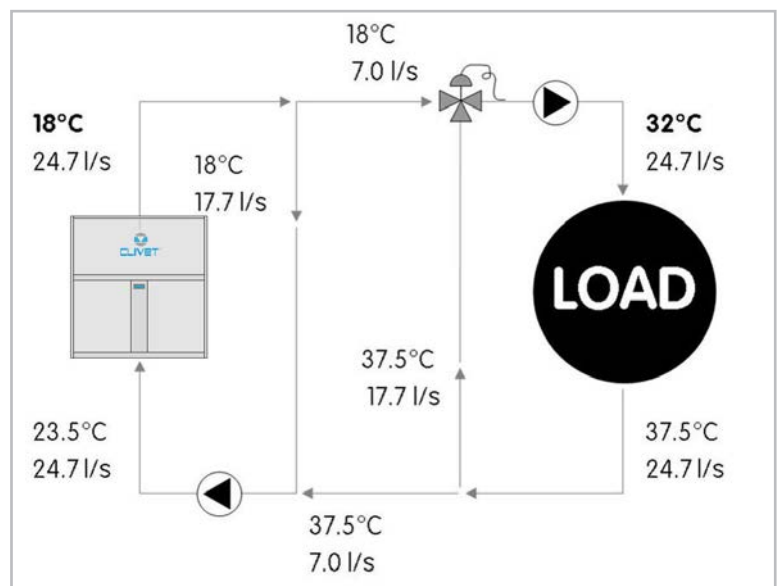

Example referred to WSH-XSC3 160.4.
Appropriate supply water temperature for the correct unit operation. Nominal water flow rate.

Evaporator thermal gradient

SPINchiller³ nominal capacities refer to an evaporator thermal gradient equal to 5 °C. A different thermal gradient may be used in full load operation, provided that both the operating flow and temperatures fall within the limits. As an indication, this corresponds to a minimum thermal gradient of approximately 3 °C and a maximum of 10 °C (the exact values must be determined based on the allowed flows and temperatures).

Standard unit technical specifications

Compressor

High efficiency hermetic orbiting scroll compressor complete with oil charge, motor over-temperature and over-current devices and protection against excessive gas discharge temperature with oil heater, which starts automatically, keeps the oil from being diluted by the refrigerant when the compressor stops. Compressors, fitted on rubber antivibration mounts to prevent transmission of noise and vibration, are connected in TANDEM on a single refrigerating circuit with biphasic oil equalisation, it allows to reach high efficiency at partial load. Uniform compression process with reduced number of moving parts which ensure very low levels of noise and vibration.

Structure

Structure and base made entirely of sturdy sheet steel, thickness of 30/10 or 40/10, with the surface treatment in Zinc-Magnesium painted, for the parts in view, with polyester powder RAL 9001 that guarantees excellent mechanical characteristics and high corrosion strength over time.

Panelling

External pre-painted zinc-magnesium paneling, thickness 20/10, with the surface treatment in Zinc-Magnesium painted with polyester powder RAL 9001 that ensures superior resistance to corrosion for outdoor installation and eliminates the need for periodical painting. The panels can be easily removed to fully access internal components and are lined with sound-proof material on the inside to contain the unit's sound levels.

Internal exchanger

Direct expansion heat exchanger, braze-welded AISI 316 stainless steel plates, in pack without seals using copper as the brazing material, with low refrigerant charge and large exchange surface, complete with:

- external thermal insulation no-condensation, thickness 9,5 mm, in extruded elastomer foam with closed cells;
- differential pressure switch, water side;
- water temperature probes.

Maximum operating pressure exchanger: 10 bar on the water side and 45 bar on the refrigerant side.

External exchanger

Direct expansion heat exchanger, braze-welded AISI 316 stainless steel plates, in pack without seals using copper as the brazing material, with low refrigerant charge and large exchange surface, complete with:

- external thermal insulation no-condensation, thickness 9,5 mm, in extruded elastomer foam with closed cells;
- differential pressure switch, water side;
- water temperature probes.

Maximum operating pressure exchanger: 10 bar on the water side and 45 bar on the refrigerant side.

Refrigeration circuit

Two independent refrigeration circuits, copper made and factory-assembled, welded with continuity metallic solution, completed with:

- replaceable antiacid dehydrator filter with solid cartridge;
- liquid flow and moisture indicator;
- electronic expansion valve;
- high pressure safety pressure switch;
- low pressure transducer;
- high pressure transducer;
- low pressure safety valve;
- high pressure safety valve;
- cutoff valve on liquid line;
- refrigerant temperature probes

Thermal insulated of suction line with insulation material in highly flexible closed-cell elastomer based on EPDM rubber. Refrigeration circuit pressure tested to check leaks and supplied complete of refrigerant charge.

Configurations

D - Partial energy recovery

BN - Basic acoustic configuration

EN - Super-silenced acoustic configuration

Electrical panel

Fully constructed and wired in accordance with EN 60204. The capacity section includes:

- main door lock isolator switch;
- terminals main power (400V / 3Ph / 50Hz);
- isolating transformer for auxiliary circuit power supply (230V/24V);
- compressor circuit breaker;
- compressor control contactor;
- double winding on compressor for reduction of inrush current (in the range between 180.4 and 240.4).

The control section includes:

- interface terminal with graphic display;
- display of the set values, the error codes and the parameter index;
- ON/OFF and alarm reset buttons;
- proportional-integral-derivative water temperature control;
- daily, weekly programmer of temperature set-point and unit on/off;
- unit switching on management by local or remote;
- antifreeze protection water side;
- compressor overload protection and timer;
- pre-alarm function for water antifreeze and high refrigerant gas pressure;
- self-diagnosis system with immediate display of the fault code;
- automatic rotation control for compressor starts;
- compressor operating hour display;
- remote ON/OFF control input;
- input for remote HEAT/COOL control;
- relay for remote cumulative fault signal;
- input for demand limit (absorbed power limit according to an external signal 0÷10V);
- potential-free contacts for compressor status;
- digital input for double set-point enabling;
- phase monitor;
- electrical panel ventilation;
- 0÷10V signal output and potential free contact for auxiliary heater;
- numbering of electrical panel cables;
- set-up for natural cooling management (provided by the Customer);
- set-up for one ON/OFF or modulating pump control user and source side.

All device functions can be repeated with a normal portable PC connected to the unit with an Ethernet cable and equipped with an internet navigation browser. All electrical cables are colored and numbered in accordance with the wiring diagram.

Accessories - Hydronic assembly

- VARYFLOW + (2 inverter pumps)
- Hydronic assembly with 1 ON/OFF pump
- Hydronic assembly with 2 ON/OFF pumps
- HYDROPACK with 2 pumps
- 2-way modulating valve
- 2-way modulating valve for high DP
- 3-way modulating valve (accessory separately provided)
- Steel mesh strainer on the water side (accessory separately provided). Note: To be located at the exchanger inlet. We disclaim any liability and make the guarantee void, if an appropriate mechanical filter is not provided inside the system.

Accessories

- High and low pressure gauges
- Antifreeze heater for internal exchanger protection
- Source side antifreeze electric heaters
- Cutoff valve on compressor supply and return
- Couple of manually operated shut-off valves (accessory separately supplied)
- Power factor correction capacitors (cosφ > 0.9)
- ECOSHARE function for the automatic management of a group of units
- Disposal for inrush current reduction
- Serial communication module for BACnet supervisor
- Serial communication module for Modbus supervisor
- Serial communication module for LonWorks supervisor
- Remote control via microprocessor control (accessory separately supplied)
- Mains power supply (accessory separately supplied)
- Energy meter
- Set-point compensation with 0-10 V signal
- Set-point compensation with outdoor air temperature probe
- Antivibration mount support (accessory separately supplied)
- Refrigerant leak detector with pump down function in the casing
- Inverter driven variable flow-rate user side control depending on the temperature differential
- Multifunction phase monitor
- Rear water fittings (only for basic acoustic configuration)

Test

Unit subjected to factory-tested in specific steps and test pressure of the piping of the refrigerant circuit (with nitrogen and hydrogen), before shipping them. After the approval, the moisture contents present in all circuits are analyzed, in order to ensure the respect of the limits set by the manufacturers of the different components.

System solutions

Cooling only unit:

- ▶ Production of chilled water (Operation Cooling-only)

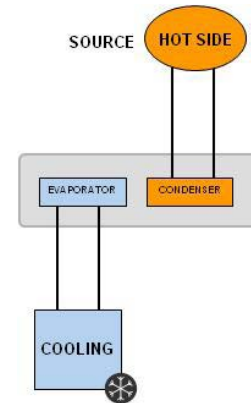
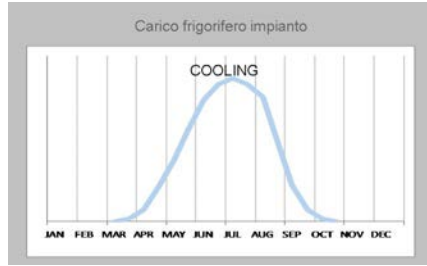

- ▶ Production of chilled water (Operation Cooling-only)
- ▶ Production of domestic hot water from partial recovery (example post-heat)

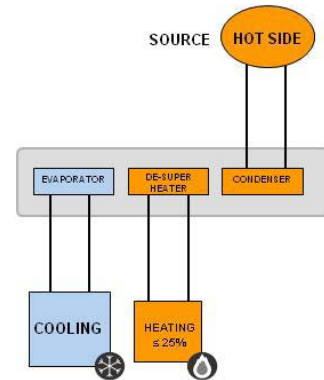
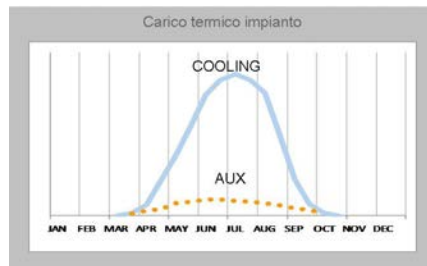

Heating only unit:

- ▶ Production of hot water (Operation Heating-only)

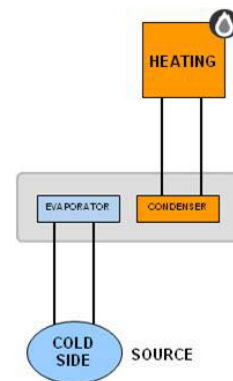
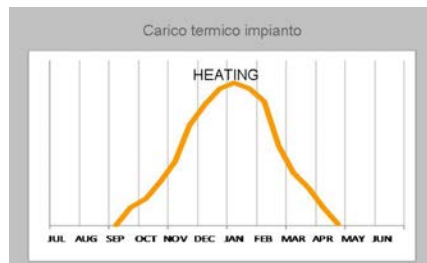

Unit configuration: heating only

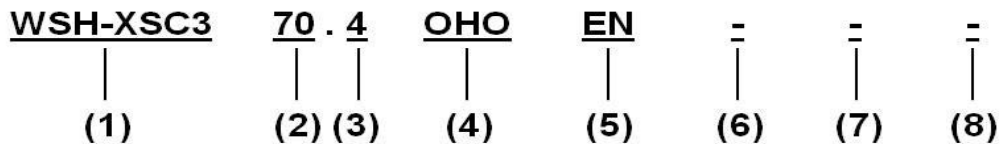

(1) Range

WSH - Water cooled chiller with scroll compressor
 XSC3 - SPINchiller³ range

(2) Size

70 - Nominal compressor capacity in HP

(3) Compressors

4 - Compressor quantity

(4) Operation

OCO - Cooling only
 OHO - Heating only (standard)
 OHI - Operation with water circuit change-over

(5) Acoustic configuration

EN - Super-silenced acoustic configuration (standard)
 BN - Basic acoustic configuration

(6) Condensation heat recovery

(-) not required (standard)
 D - Partial energy recovery (25% of available heat)

(7) Hydronic assembly source side/ cold

(-) not required (standard)
 VARYC - Varyflow + (cooling side 2 inverter pumps)
 HYG1 - Cooling side hydronic assembly with 1 ON/OFF pump
 HYG2 - Cooling side hydronic assembly with 2 ON/OFF pumps
 2PMC - Hydropack cooling side with 2 pumps
 VS2MC - Cooling side 2-way modulating valve
 V2MCP - Cooling side 2-way modulating valve for high DP

(8) Hydronic assembly user side / hot

(-) not required (standard)
 VARYH - Varyflow + (heating side 2 inverter pumps)
 HYG1 - Heating side hydronic assembly with 1 ON/OFF pump
 HYG2 - Heating side hydronic assembly with 2 ON/OFF pumps
 2PMH - Hydropack heating side with 2 pumps

N.B: For a correct unit operation is necessary that the leaving water temperatures, source and user side, are within the indicated operating range.

If at the variation of the operation conditions is necessary to significantly vary the water flow-rate or if the design water flow-rate is close to the minimum limit indicated in the "Admissible water flow-rate" table, is mandatory to equip the unit with a flow rate modulation, source side.

The modulation can be supplied by Clivet or will be provided by the Customer which should also arrange the connection to the unit.

Functionalities	Diagram hydronic assemblies - Heating only unit				
SOURCE SIDE/ COLD	Standard unit (Std)	Unit with VARYFLOW + (VARYC)	Unit with 1 ON/OFF pump (HYG1)	Unit with 2 ON/OFF pumps (HYG2)	
	Unit with Hydropack (2PMC)	Unit with 2-way modulating valve (VS2MC)	Unit with 2-way modulating valve for high DP (V2MCP)		
	Standard unit (Std)	Unit with VARYFLOW + (VARYH)	Unit with 1 ON/OFF pump (HYGH1)	Unit with 2 ON/OFF pumps (HYGH2)	Unit with Hydropack (2PMH)
USER SIDE/ HOT					

Unit configuration: cooling only

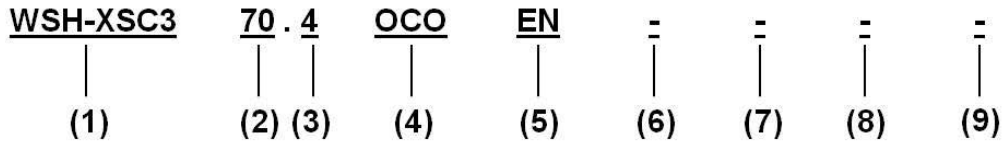

(1) Range

WSH - Water cooled chiller with scroll compressor
XSC3 - SPINchiller3 range

(2) Size

70 - Nominal compressor capacity in HP

(3) Compressors

4 - Compressor quantity

(4) Operation

OCO - Cooling only
OHO - Heating only (standard)
OHI - Operation with water circuit change-over

(5) Acoustic configuration

EN - Super-silenced acoustic configuration (standard)
ST - Standard acoustic configuration

(6) Condensation heat recovery

(-) not required (standard)
D - Partial energy recovery (25% of available heat)

(7) Low evaporator water temperature configuration

(-) not required (standard)
B - Low water temperature, down to -8°C (Brine)

(8) Hydronic assembly source side/ cold

(-) not required (standard)
VARYC - Varyflow + (cooling side 2 inverter pumps)
HYGC1 - Cooling side hydronic assembly with 1 ON/OFF pump
HYGC2 - Cooling side hydronic assembly with 2 ON/OFF pumps
2PMC - Hydropack cooling side with 2 pumps

(9) Hydronic assembly user side / hot

(-) not required (standard)
VARYH - Varyflow + (Heating side 2 inverter pumps)
HYGH1 - Heating side hydronic assembly with 1 on-off pump
HYGH2 - Heating side hydronic assembly with 2 on-off pumps
2PMH - Hydropack heating side with 2 pumps
VS2MH - Heating side 2-way modulating valve
V2MHP - Heating side 2-way modulating valve for high DP
VS3MH - Heating side 3-way modulating valve

N.B: For a correct unit operation is necessary that the leaving water temperatures, source and user side, are within the indicated operating range.

If at the variation of the operation conditions is necessary to significantly vary the water flow-rate or if the design water flow-rate is close to the minimum limit indicated in the "Admissible water flow-rate" table, is mandatory to equip the unit with a flow rate modulation, source side.

The modulation can be supplied by Clivet or will be provided by the Customer which should also arrange the connection to the unit.

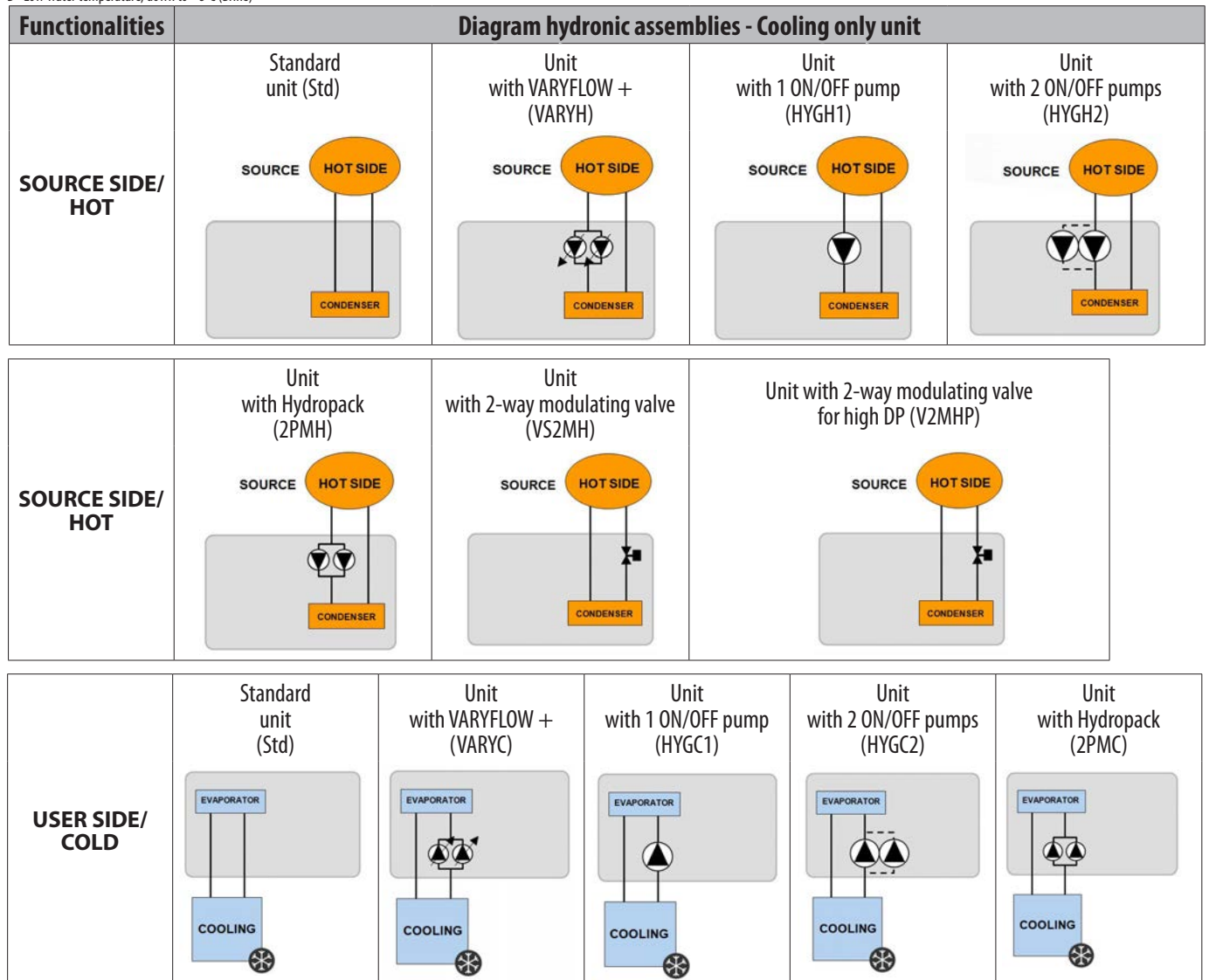

General technical data - Performance

Size			70.4	75.4	80.4	85.4	90.4	100.4	110.4	120.4	140.4	160.4	180.4	200.4	220.4	240.4
Cooling																
Cooling capacity	1	[kW]	218	232	248	269	292	320	351	396	451	504	570	625	676	733
Compressor power input	1	[kW]	45,4	49,0	51,9	56,9	60,5	66,5	73,7	81,4	93,2	105	118	130	142	156
Total power input	2	[kW]	45,5	49,1	52,0	57,0	60,6	66,6	73,8	81,5	93,3	105	119	130	143	156
Partial recovery heating capacity	3	[kW]	42,9	45,8	48,9	53,1	57,5	63,0	69,2	77,8	88,6	99,3	112	123	133	145
EER	1	-	4,80	4,72	4,78	4,73	4,83	4,81	4,76	4,87	4,84	4,81	4,81	4,81	4,75	4,70
Water flow-rate user side / cooling	1	[l/s]	10,4	11,1	11,9	12,8	14,0	15,3	16,8	18,9	21,5	24,1	27,2	29,9	32,3	35,0
Pressure drop user side / cooling	1	[kPa]	28	31	29	34	33	32	34	39	40	43	45	58	56	53
Water flow-rate source side / heating	1	[l/s]	12,6	13,4	14,3	15,6	16,9	18,5	20,3	22,8	26	29,1	32,9	36,1	39,1	42,5
Pressure drop source side / hot	1	[kPa]	22	25	23	27	27	22	22	27	37	37	39	40	38	41
Cooling capacity (EN14511:2013)	4	[kW]	217	231	248	268	292	319	350	395	449	503	568	623	674	731
Total power input (EN14511:2013)	4	[kW]	46,5	50,3	53,2	58,4	61,8	68,1	75,5	83,6	95,7	108	122	133	146	160
EER (EN 14511:2013)	4	-	4,67	4,59	4,65	4,59	4,72	4,68	4,64	4,72	4,69	4,67	4,66	4,67	4,60	4,56
SEER	8	-	6,16	6,24	6,18	6,06	6,01	5,73	5,65	5,91	6,04	5,88	5,88	5,89	5,89	5,89
Cooling capacity (AHRI 550/590)	5	[kW]	218	232	249	270	291	318	350	397	452	506	571	626	677	735
Total power input (AHRI 550/590)	5	[kW]	44,5	48,1	50,9	55,7	59,8	65,8	72,5	79,8	91,4	103	116	127	140	153
COP _R	5		4,90	4,82	4,89	4,85	4,87	4,83	4,83	4,97	4,95	4,91	4,92	4,93	4,84	4,80
IPLV	5		6,75	6,59	6,70	6,62	6,58	6,40	6,54	6,61	6,81	6,64	6,65	6,64	6,54	6,60
Heating																
Heating capacity	6	[kW]	249	265	284	308	332	365	400	451	516	576	653	718	778	845
Compressor power input	6	[kW]	55,2	59,6	62,2	69,1	74,0	80,7	89,4	99,1	113	126	144	157	173	190
Total power input	2	[kW]	55,3	59,7	62,3	69,2	74,1	80,8	89,5	99,2	113	126	144	157	173	190
COP	6	-	4,51	4,45	4,58	4,46	4,49	4,53	4,47	4,56	4,58	4,57	4,53	4,57	4,49	4,44
Water flow-rate user side / hot	6	[l/s]	11,9	12,7	13,6	14,7	15,9	17,4	19,1	21,6	24,6	27,5	31,2	34,3	37,2	40,4
Pressure drop user side / hot	6	[kPa]	20	22	21	24	24	19	20	24	34	34	35	36	34	37
Water flow-rate source side / cold	6	[l/s]	9,2	9,8	10,6	11,4	12,3	13,6	14,8	16,8	19,3	21,5	24,3	26,8	28,9	31,3
Pressure drop source side / cold	6	[kPa]	22	25	24	27	26	26	27	31	33	34	36	48	45	43
Heating capacity (EN14511:2013)	7	[kW]	249	266	285	309	333	366	401	453	517	578	655	720	780	847
Total power input (EN14511:2013)	7	[kW]	56,8	61,5	64,2	71,5	76,3	83,5	92,6	103	117	131	150	163	180	197
COP (EN 14511:2013)	7	-	4,39	4,32	4,44	4,32	4,36	4,38	4,33	4,41	4,42	4,41	4,36	4,41	4,33	4,29

The Product is compliant with the Erp (Energy Related Products) European Directive. It includes the Commission delegated Regulation (EU) No 2016/2281, also known as Ecodesign Lot21.

'Contains fluorinated greenhouse gases'(GWP 2087,5)

1. Data referred to the following conditions: Internal exchanger water temperature = 12/7 °C. External exchanger water temperature = 30/35°C. Evaporator fouling factor = $0.44 \times 10^{(-4)}$ m² K/W
2. The Total Power Input value does not take into account the part related to the pumps and required to overcome the pressure drops for the circulation of the solution inside the exchangers
3. Option. Recovery exchanger water=40/45°C
4. Data compliant to Standard EN 14511:2013 referred to the following conditions: Internal exchanger water temperature = 12/7°C. External exchanger water temperature = 30/35°C
5. Data compliant to Standard AHRI 550/590 referred to the following conditions: internal exchanger water temperature = 6,7 °C. Water flow-rate 0,043 l/s per kW. Entering external exchanger air temperature 35°C. Evaporator fouling factor = $0.18 \times 10^{(-4)}$ m² K/W
6. Data referred to the following conditions: Internal exchanger water temperature = 40/45 °C. External exchanger water temperature = 10/7°C. Evaporator fouling factor = $0.44 \times 10^{(-4)}$ m² K/W
7. Data compliant to Standard EN 14511:2013 referred to the following conditions: Internal exchanger water temperature = 40/45 °C. External exchanger water temperature = 10/7°C.
8. Data calculated according to the EN 14825:2016 Regulation

General technical data - Construction

Size			70.4	75.4	80.4	85.4	90.4	100.4	110.4	120.4	140.4	160.4	180.4	200.4	220.4	240.4
Compressor																
Type of compressors		-	SCROLL													
Refrigerant		-	R-410A													
No. of compressors		Nr	4	4	4	4	4	4	4	4	4	4	4	4	4	4
Rated power (C1)		[HP]	35	35	40	40	45	50	55	60	70	80	90	100	100	120
Rated power (C2)		[HP]	35	40	40	45	45	50	55	60	70	80	90	100	120	120
Std Capacity control steps		Nr	6	6	6	6	6	6	6	4	6	4	6	6	6	4
Oil charge (C1)		[l]	8	8	10	12	11	11	13	13	13	13	13	13	13	13
Oil charge (C2)		[l]	8	10	10	12	11	11	13	13	13	13	13	13	13	13
Refrigerant charge (C1)	1	[kg]	12,0	12,0	15,0	15,0	16,0	18,0	20,0	20,0	25,0	26,0	28,0	30,0	30,0	32,0
Refrigerant charge (C2)	1	[kg]	12,0	12,0	15,0	15,0	16,0	18,0	20,0	20,0	25,0	26,0	28,0	30,0	30,0	32,0
Refrigeration circuits		Nr	2	2	2	2	2	2	2	2	2	2	2	2	2	2
Internal exchanger / cooling side																
No. of internal exchangers		Nr	1	1	1	1	1	1	1	1	1	1	1	1	1	1
Type of internal exchanger	2	-	PHE													
Water content		[l]	17,1	17,1	20,0	20,0	23,9	26,7	29,5	32,3	42,1	47,3	54,6	49,6	54,0	59,9
Minimum system water content	3	[l]	1020	1000	980	980	1000	1370	1740	2230	2120	2850	1990	2690	2540	4140
External exchanger / heating side																
No. of internal exchangers		Nr	1	1	1	1	1	1	1	1	1	1	1	1	1	1
Type of internal exchanger	2	-	PHE													
Water content		[l]	26,7	26,7	32,3	32,3	37,9	54,6	59,8	67,1	55,5	62,9	70,3	77,7	85,1	92,5
Connections																
Water fittings		-	4"	4"	4"	4"	4"	4"	4"	5"	5"	5"	5"	5"	5"	5"
Power supply																
Standard power supply		V	400/3/50	400/3/50	400/3/50	400/3/50	400/3/50	400/3/50	400/3/50	400/3/50	400/3/50	400/3/50	400/3/50	400/3/50	400/3/50	400/3/50
Electrical data																
FLA Total		A	135,0	143,4	151,8	166,2	180,6	191,9	208,7	237,5	266,5	295,5	346,9	375,9	416,1	456,3
FLI Total		kW	79,3	84,1	88,9	97,7	106,5	117,4	127,0	144,6	165,8	187,0	212,6	233,8	257,2	280,6
M.I.C. - Value	4	A	323,2	370,2	378,6	416,6	431,0	442,3	459,1	487,9	586,4	615,4	616,6	645,6	685,8	726,0
M.I.C. - with soft start accessory	4	A	226,0	237,4	245,8	278,8	293,2	304,5	321,3	350,1	414,4	443,4	-	-	-	-

1. Indicative values for standard units with possible +/-10% variation. The actual data are indicated on the label of the unit.
2. PHE = Plate exchanger
3. The minimum system water content calculated value does not consider the internal exchanger water content. With outdoor air low temperature applications or low medium requested loads, the minimum installation water volume is obtained doubling the indicated value
4. M.I.C.=Maximum unit starting current. The M.I.C. value is obtained adding the max. compressor starting current of the highest size to the power input at max. admissible conditions (F.L.A.) of the remaining electric components.

Sound level

Super-silenced acoustic configuration EN (standard)

Size	Sound Power Level [dB]								Sound Pressure Level	Sound Power Level
	Octave band (Hz)									
	63	125	250	500	1000	2000	4000	8000	dB(A)	dB(A)
70.4	57	70	75	76	75	76	67	66	63	81
75.4	57	68	75	76	77	77	69	68	64	82
80.4	57	66	75	76	78	78	70	70	65	83
85.4	57	66	75	77	79	78	70	69	65	83
90.4	57	66	75	78	79	77	70	69	65	83
100.4	57	70	78	79	80	79	70	67	66	84
110.4	57	67	78	79	81	80	72	71	68	85
120.4	57	67	78	80	82	80	72	70	68	86
140.4	57	66	79	81	85	83	73	71	70	88
160.4	57	66	80	81	86	84	74	71	72	90
180.4	57	76	94	80	82	81	76	74	71	89
200.4	57	76	94	81	85	83	76	74	72	90
220.4	57	78	95	81	83	83	77	75	72	90
240.4	57	79	97	81	82	82	78	76	73	91

Sound levels refer to units with full load under nominal test conditions.
 The sound pressure level refers to a distance of 1 meter from the outer surface of the unit operating in open field.
 Noise levels are determined using the tensiometric method (UNI EN ISO 9614-2)
 Data referred to the following conditions:
 entering / leaving exchanger water temperature user side 12/7°C
 entering / leaving exchanger water temperature source side 30/35°C

Basic unit configuration BN

Size	Sound Power Level [dB]								Sound Pressure Level	Sound Power Level
	Octave band (Hz)									
	63	125	250	500	1000	2000	4000	8000	dB(A)	dB(A)
70.4	48	69	79	81	82	85	78	71	71	89
75.4	48	67	79	81	84	86	80	73	72	90
80.4	48	65	79	81	85	87	81	75	73	91
85.4	48	65	79	82	86	87	81	74	73	91
90.4	48	65	79	83	86	86	81	74	73	91
100.4	48	69	82	84	87	88	81	72	74	92
110.4	48	66	82	84	88	89	83	76	76	93
120.4	48	66	82	85	89	89	83	75	76	94
140.4	48	65	83	86	92	92	84	76	78	96
160.4	48	65	84	86	93	93	85	76	79	97
180.4	49	76	99	86	90	91	88	80	79	97
200.4	49	76	99	87	93	93	88	80	80	98
220.4	49	78	100	87	91	93	89	81	80	98
240.4	49	79	102	87	90	92	90	82	80	98

Sound levels refer to units with full load under nominal test conditions.
 The sound pressure level refers to a distance of 1 meter from the outer surface of the unit operating in open field.
 Noise levels are determined using the tensiometric method (UNI EN ISO 9614-2)
 Data referred to the following conditions:
 entering / leaving exchanger water temperature user side 12/7°C
 entering / leaving exchanger water temperature source side 30/35°C

Cooling only unit

Operating range - Cooling



Twu [°C] = Leaving water temperature user side / cold
 TwS [°C] = Leaving water temperature source side / hot
 The limits refer to $\Delta T=5^\circ\text{C}$ on both the heating and cooling sides

1. Normal operating range
2. Operating range where is mandatory to select the water low temperature configuration (B) and the use of a mixture of water and glycol in relation to the leaving exchanger water temperature, cooling side

Heating only unit

Operating range - Heating

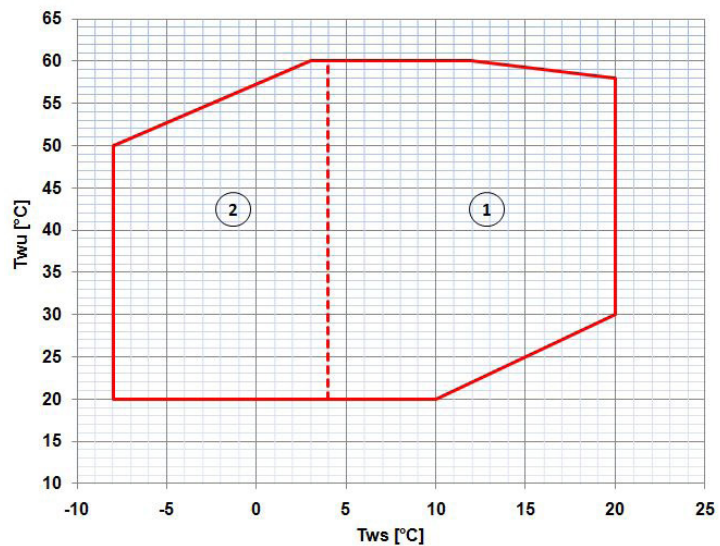

Twu [°C] = Leaving water temperature user side / hot
 TwS [°C] = Leaving water temperature source side / cold
 The limits refer to $\Delta T=5^\circ\text{C}$ on both the heating and cooling sides

1. Normal operating range
2. Operating range where is mandatory the use of a mixture of water and glycol in relation to the leaving exchanger water temperature, cooling side

Admissible water flow-rates

Minimum (Qmin) and maximum (Qmax) admissible water flow for the unit to operate correctly.

Size			70.4	75.4	80.4	85.4	90.4	100.4	110.4	120.4	140.4	160.4	180.4	200.4	220.4	240.4
Heating side	Qmin	[l/s]	8	8	9	9	9	13	14	14	14	15	17	18	20	21
	Qmax	[l/s]	25	25	28	28	30	37	40	42	39	44	48	53	58	61
Cooling side	Qmin	[l/s]	6	6	6	6	7	8	8	9	11	12	13	12	14	15
	Qmax	[l/s]	19	19	21	21	23	25	27	28	31	34	37	36	39	44

Correction factors for glycol use

% ethylene glycol by weight		5%	10%	15%	20%	25%	30%	35%	40%	45%	50%
Freezing temperature	°C	-2,0	-3,9	-6,5	-8,9	-11,8	-15,6	-19,0	-23,4	-27,8	-32,7
Safety temperature	°C	3	1	-1	-4	-6	-10	-14	-19	-24	-30
Internal exchanger cooling Capacity Factor	-	0,995	0,990	0,985	0,981	0,977	0,974	0,971	0,968	0,966	0,964
Internal exchanger compressor power input Factor	-	0,997	0,993	0,990	0,988	0,986	0,984	0,982	0,981	0,980	0,979
Internal exchanger glycol solution flow factor	-	1,003	1,010	1,020	1,033	1,050	1,072	1,095	1,124	1,156	1,192
Internal exchanger pressure drop Factor	-	1,029	1,060	1,090	1,118	1,149	1,182	1,211	1,243	1,272	1,302
External exchanger cooling Capacity Factor	-	0,999	0,997	0,995	0,992	0,989	0,986	0,983	0,979	0,975	0,971
External exchanger compressor power input Factor	-	1,003	1,006	1,009	1,012	1,016	1,021	1,026	1,031	1,038	1,044
External exchanger glycol solution flow factor	-	1,004	1,011	1,020	1,031	1,043	1,056	1,071	1,088	1,107	1,128
External exchanger pressure drop Factor	-	1,027	1,062	1,103	1,149	1,200	1,256	1,318	1,387	1,466	1,550

The correction factors shown refer to water and glycol ethylene mixes used to prevent the formation of frost on the exchangers in the water circuit during inactivity in winter.

Fouling Correction Factors

m ² °C / W	Internal exchanger		External exchanger	
	F1	FK1	F2	FK2
0.44 x 10 (-4)	1,0	1,0	1,0	1,0
0.88 x 10 (-4)	0,97	0,99	0,97	1,08
1.76 x 10 (-4)	0,94	0,98	0,92	1,05

F1 = Cooling capacity correction factors

FK1 = Compressor power input correction factor

Overload and control device calibrations

		Intervention	Reset	Value
High pressure safety pressure switch (gas side)	[kPa]	4050	3300	-
Low pressure alarm (gas side)	[kPa]	450	600	-
Antifreeze protection	[°C]	4	6,0	-
High pressure safety valve (gas side)	[kPa]	-	-	4500
Low pressure safety valve (gas side)	[kPa]	-	-	3000
Max no. of compressor starts per hour (gas side)	[n°]	-	-	10
Differential pressure switch (water side)	[kPa]	8	10,5	-
Max pressure without hydronic assembly (water side)	[kPa]	-	-	1000
Max pressure with hydronic assembly (water side)	[kPa]	-	-	600
Safet valve setting (water side) (1)	[kPa]	-	-	600

(1) Available only with hydronic assembly option

Cooling side pressure drop

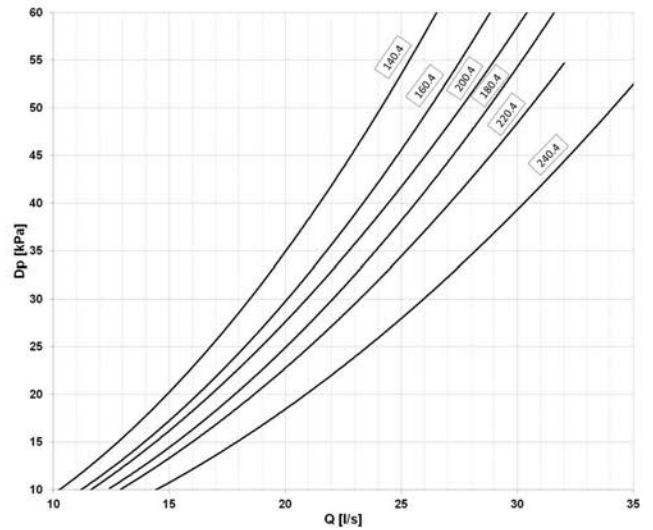
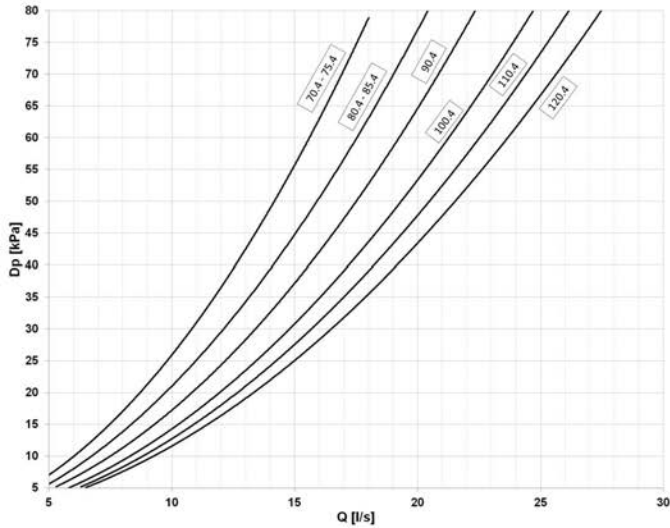

The pressure drops are calculated considering a water temperature of 7°C

Q = water flow-rate[l/s]
 DP = water side pressure drops (kPa)

The water flow-rate must be calculated with the following formula

$$Q [l/s] = kWf / (4,186 \times DT)$$

kWf = Cooling capacity in kW
 DT = Different between entering/leaving water temperature

Heating side pressure drop

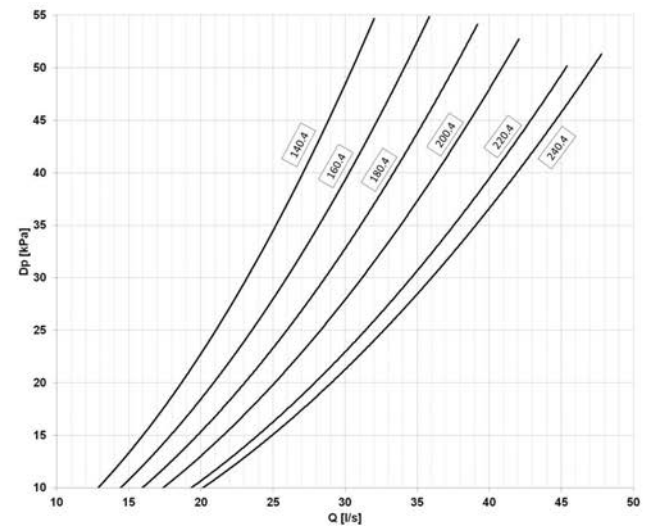
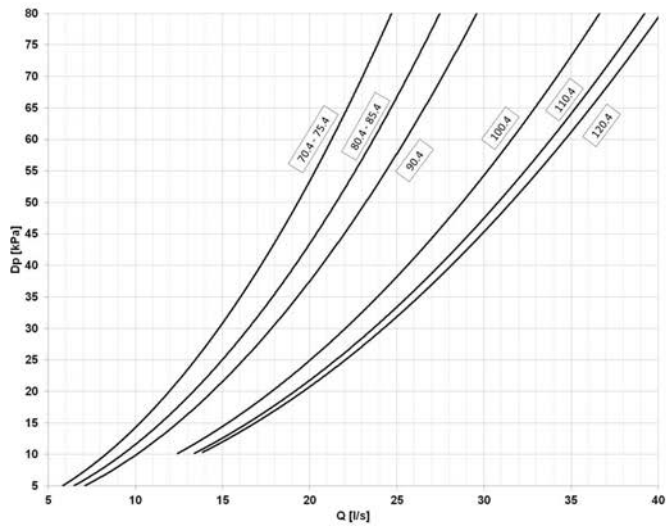

The pressure drops are calculated considering a water temperature of 45°C

Q = water flow-rate[l/s]
 DP = water side pressure drops (kPa)

The water flow-rate must be calculated with the following formula

$$Q [l/s] = kWf / (4,186 \times DT)$$

kWf = Cooling capacity in kW
 DT = Different between entering/leaving water temperature



To the internal exchanger pressure drops must be added the pressure drops of the steel mesh mechanical strainer that must be placed on the water input line. It is a device compulsory for the correct unit operation, and it is available as Clivet option (see the HYDRONIC ASSEMBLY ACCESSORIES). If the mechanical filter is selected and installed by the Customer, it is forbidden the use of filters with the mesh pitch higher than 1,6 mm, because they can cause a bad unit operation and also its serious damaging.

Cooling only unit

Cooling performance

Size	To (°C)	ENTERING WATER TEMPERATURE SOURCE SIDE / HOT (°C)											
		25		30		35		40		45		50	
		kWf	kWe	kWf	kWe	kWf	kWe	kWf	kWe	kWf	kWe	kWf	kWe
70.4	5	214	40.8	205	45.0	194	49.6	179	55.1	165	60.7	154	68.1
	7	227	41.1	218	45.4	206	50.0	191	55.6	175	61.1	164	68.4
	10	249	41.6	239	46.0	226	50.8	210	56.3	193	61.8	182	69.2
	12	265	41.9	254	46.4	241	51.2	223	56.8	206	62.4	194	69.7
	15	289	42.2	277	46.9	264	51.9	244	57.6	225	63.3	214	70.6
	18	-	-	303	47.4	288	52.5	267	58.3	246	64.2	235	71.4
75.4	5	227	44.1	218	48.6	206	53.6	191	59.5	175	65.4	164	73.2
	7	242	44.4	232	49.0	219	54.1	203	60.0	186	65.9	174	73.6
	10	264	44.9	254	49.6	240	54.8	223	60.8	205	66.7	193	74.4
	12	281	45.3	269	50.1	255	55.3	237	61.3	218	67.3	206	74.9
	15	307	45.7	294	50.6	279	56.0	259	62.1	239	68.2	228	75.8
	18	-	-	321	51.2	305	56.7	282	62.9	260	69.1	250	76.7
80.4	5	243	46.7	233	51.5	221	56.9	205	63.1	189	69.3	176	77.3
	7	259	47.0	248	51.9	235	57.3	218	63.6	201	69.8	187	77.7
	10	284	47.5	272	52.5	258	58.0	239	64.3	220	70.6	206	78.5
	12	302	47.8	289	52.9	275	58.5	255	64.8	235	71.1	221	79.0
	15	329	48.2	316	53.5	300	59.1	279	65.5	257	71.9	243	79.8
	18	-	-	345	54.0	327	59.8	304	66.3	281	72.8	267	80.6
85.4	5	263	51.1	253	56.3	239	62.2	222	69.0	204	75.9	190	84.8
	7	280	51.5	269	56.8	255	62.7	236	69.6	217	76.4	203	85.3
	10	307	52.1	295	57.6	279	63.5	258	70.4	238	77.4	224	86.1
	12	326	52.5	313	58.1	296	64.1	275	71.0	253	78.0	239	86.7
	15	357	53.1	342	58.8	324	64.9	300	72.0	277	79.0	263	87.7
	18	-	-	374	59.5	354	65.8	328	72.9	302	80.1	289	88.9
90.4	5	285	54.8	272	60.6	257	66.9	238	74.5	218	82.1	204	91.9
	7	303	55.2	290	61.0	274	67.3	253	75.0	232	82.6	217	92.3
	10	333	55.8	319	61.7	302	68.1	279	75.8	256	83.4	241	93.1
	12	354	56.2	339	62.1	321	68.7	297	76.3	273	84.0	257	93.7
	15	388	56.7	371	62.8	352	69.5	326	77.3	300	85.1	284	94.8
	18	-	-	407	63.4	386	70.3	357	78.2	328	86.1	312	95.8
100.4	5	312	60.6	298	66.5	282	73.2	261	81.2	241	89.3	225	101
	7	332	61.2	317	67.0	301	73.7	279	81.7	257	89.8	240	101
	10	365	62.1	349	68.1	331	74.6	307	82.6	283	90.7	266	102
	12	388	62.8	371	68.8	352	75.2	327	83.2	302	91.3	285	103
	15	426	63.9	406	69.8	386	76.3	359	84.3	332	92.3	314	104
	18	-	-	447	71.0	423	77.4	394	85.5	364	93.5	346	105
110.4	5	343	66.7	328	73.3	310	80.7	288	89.5	265	98.3	247	110
	7	365	67.3	349	73.9	331	81.3	306	90.0	282	98.8	264	111
	10	400	68.3	383	74.9	363	82.1	337	90.9	311	99.8	292	112
	12	426	69.1	408	75.7	387	82.8	359	91.5	332	100	312	112
	15	467	70.1	447	76.7	424	83.8	394	92.6	364	101	344	113
	18	-	-	490	77.9	464	85.0	432	93.7	399	102	379	114
120.4	5	387	73.4	371	80.6	352	89.4	327	99.6	301	110	281	123
	7	413	74.2	396	81.4	375	90.0	348	100	321	111	300	124
	10	452	75.5	434	82.8	411	91.3	382	102	353	112	331	125
	12	482	76.5	462	83.8	438	92.2	407	102	376	113	354	126
	15	528	77.9	506	85.3	479	93.7	446	104	412	114	389	127
	18	-	-	551	86.8	522	95.2	486	106	450	116	426	129
140.4	5	442	84.1	424	92.1	402	102	374	113	346	124	323	138
	7	471	85.3	451	93.2	427	103	398	114	368	125	344	139
	10	515	87.3	493	95.1	468	105	436	116	404	127	379	141
	12	547	88.7	525	96.6	498	106	464	117	429	128	405	142
	15	598	91.0	575	98.8	545	108	508	119	470	130	445	144
	18	-	-	629	101	597	110	556	121	515	132	490	146

kWf = Cooling capacity in kW. The data do not consider the part related to the pumps, required to overcome the pressure drop for the solution circulation inside the exchangers

kWe = Compressor power input in kW

To = Leaving water temperature user side / cold (°C)

Performance refer to DT = 5°C both cold and heating side.

Cooling only unit

Cooling performance

Size	To (°C)	ENTERING WATER TEMPERATURE SOURCE SIDE / HOT (°C)											
		25		30		35		40		45		50	
		kWf	kWe	kWf	kWe	kWf	kWe	kWf	kWe	kWf	kWe	kWf	kWe
160.4	5	500	95.0	481	104	455	114	423	126	391	139	365	153
	7	525	96.3	504	105	477	116	443	128	409	139	383	154
	10	554	97.8	532	106	504	117	469	129	434	141	408	156
	12	586	99.6	564	108	536	118	501	130	465	143	439	157
	15	640	103	617	111	588	121	549	133	509	145	483	160
	18	-	-	666	114	634	123	591	135	547	147	522	162
180.4	5	556	107	534	117	507	129	470	144	433	159	400	179
	7	594	108	570	118	542	130	502	145	462	160	428	179
	10	650	109	624	120	594	132	551	147	507	162	471	181
	12	694	111	666	122	633	133	587	148	541	163	504	182
	15	761	112	730	124	694	135	643	150	593	165	555	184
	18	-	-	794	126	755	137	700	152	644	167	606	185
200.4	5	610	117	586	129	557	141	517	157	477	173	440	193
	7	651	118	625	130	595	143	552	158	509	174	471	194
	10	713	121	685	132	652	145	605	160	558	176	518	196
	12	760	123	730	134	694	146	645	162	595	178	554	197
	15	833	125	800	137	761	149	706	165	652	180	611	199
	18	-	-	870	140	828	152	768	167	708	183	667	202
220.4	5	660	128	634	141	604	155	560	173	516	191	475	214
	7	705	130	676	142	644	157	597	174	551	192	508	215
	10	770	132	742	145	706	159	655	176	604	194	560	217
	12	821	133	790	146	752	160	698	178	644	195	599	218
	15	900	136	865	149	824	163	764	180	705	198	659	220
	18	-	-	940	152	895	165	831	183	766	200	719	222
240.4	5	716	140	688	155	654	170	606	190	557	210	514	237
	7	764	142	733	156	698	172	646	192	594	211	549	237
	10	835	144	803	158	763	174	707	193	650	213	604	239
	12	890	145	855	160	813	175	753	195	693	215	646	240
	15	975	147	935	162	890	178	824	197	758	217	711	242
	18	-	-	1016	165	967	180	895	200	823	219	776	244

kWf = Cooling capacity in kW. The data do not consider the part related to the pumps, required to overcome the pressure drop for the solution circulation inside the exchangers

kWe = Compressor power input in kW

To = Leaving water temperature user side / cold (°C)

Performance refer to DT = 5°C both cold and heating side.

Heating only unit

Heating performance

Size	To (°C)	ENTERING WATER TEMPERATURE SOURCE SIDE / COLD (°C)											
		10		12		15		17		20		22	
		kWt	kWe	kWt	kWe	kWt	kWe	kWt	kWe	kWt	kWe	kWt	kWe
70.4	30	256	40.8	270	41.1	292	41.6	308	41.9	333	42.2	351	42.5
	35	251	45.0	265	45.4	287	46.0	302	46.4	326	46.9	343	47.2
	40	245	49.6	257	50.0	279	50.8	293	51.2	317	51.9	334	52.3
	45	236	55.1	248	55.6	268	56.3	281	56.8	304	57.6	319	58.1
	55	223	68.1	234	68.4	252	69.2	266	69.7	286	70.6	301	71.1
75.4	30	273	44.1	288	44.4	311	44.9	328	45.3	354	45.7	371	46.0
	35	268	48.6	282	49.0	305	49.6	321	50.1	346	50.6	363	51.0
	40	261	53.6	275	54.1	297	54.8	312	55.3	337	56.0	354	56.5
	45	252	59.5	264	60.0	285	60.8	300	61.3	323	62.1	339	62.6
	55	239	73.2	250	73.6	269	74.4	283	74.9	305	75.8	320	76.3
80.4	30	292	46.7	307	47.0	333	47.5	351	47.8	379	48.2	398	48.5
	35	286	51.5	302	51.9	326	52.5	344	52.9	372	53.5	390	53.8
	40	280	56.9	294	57.3	318	58.0	335	58.5	361	59.1	379	59.6
	45	270	63.1	283	63.6	305	64.3	321	64.8	346	65.5	363	66.0
	55	255	77.3	266	77.7	287	78.5	302	79.0	325	79.8	341	80.3
85.4	30	316	51.1	333	51.5	361	52.1	380	52.5	411	53.1	433	53.5
	35	311	56.3	327	56.8	354	57.6	373	58.1	403	58.8	423	59.3
	40	303	62.2	319	62.7	344	63.5	362	64.1	391	64.9	411	65.5
	45	292	69.0	307	69.6	331	70.4	348	71.0	374	72.0	393	72.6
	55	277	84.8	290	85.3	312	86.1	328	86.7	353	87.7	371	88.5
90.4	30	341	54.8	359	55.2	390	55.8	411	56.2	446	56.7	470	57.0
	35	334	60.6	352	61.0	382	61.7	403	62.1	435	62.8	459	63.2
	40	326	66.9	343	67.3	371	68.1	391	68.7	423	69.5	446	70.0
	45	314	74.5	330	75.0	356	75.8	375	76.3	405	77.3	426	77.9
	55	297	91.9	311	92.3	335	93.1	353	93.7	380	94.8	400	95.5
100.4	30	374	60.6	395	61.2	430	62.1	453	62.8	492	63.9	520	64.6
	35	366	66.5	387	67.0	419	68.1	442	68.8	478	69.8	505	70.6
	40	357	73.2	377	73.7	407	74.6	429	75.2	464	76.3	490	77.1
	45	345	81.2	363	81.7	392	82.6	413	83.2	446	84.3	469	85.1
	55	328	101	344	101	370	102	390	103	421	104	443	104
110.4	30	412	66.7	435	67.3	471	68.3	498	69.1	539	70.1	569	70.9
	35	403	73.3	425	73.9	460	74.9	486	75.7	526	76.7	555	77.5
	40	393	80.7	414	81.3	447	82.1	472	82.8	510	83.8	537	84.6
	45	380	89.5	399	90.0	430	90.9	454	91.5	489	92.6	515	93.3
	55	360	110	377	111	406	112	427	112	461	113	484	114
120.4	30	462	73.4	489	74.2	529	75.5	560	76.5	608	77.9	640	78.9
	35	454	80.6	479	81.4	519	82.8	547	83.8	593	85.3	624	86.3
	40	443	89.4	467	90.0	504	91.3	532	92.2	574	93.7	604	94.7
	45	428	99.6	450	100	485	102	511	102	552	104	579	105
	55	406	123	426	124	458	125	481	126	519	127	544	129
140.4	30	528	84.1	558	85.3	604	87.3	638	88.7	691	91.0	730	92.7
	35	518	92.1	546	93.2	590	95.1	624	96.6	676	98.8	713	100
	40	506	102	532	103	575	105	606	106	655	108	691	109
	45	489	113	514	114	554	116	583	117	629	119	662	121
	55	463	138	485	139	522	141	549	142	592	144	623	146

kWt = Internal exchanger heating capacity (kW). The data do not consider the part related to the pumps, required to overcome the pressure drop for the solution circulation inside the exchangers.

The kWt heating capacity does not consider any defrosting cycles. For the real heating capacity calculation, including defrosting cycles, please refer to "Integrated heating capacities" table.

kWe = Compressor power input in kW

To = Leaving water temperature user side / hot (°C)

Performance refer to DT = 5°C both cold and heating side.

Heating only unit

Heating performance

Size	To (°C)	ENTERING WATER TEMPERATURE SOURCE SIDE / COLD (°C)											
		10		12		15		17		20		22	
		kWt	kWe	kWt	kWe	kWt	kWe	kWt	kWe	kWt	kWe	kWt	kWe
160.4	30	597	95.0	624	96.3	654	97.8	688	99.6	745	103	782	105
	35	586	104	611	105	640	106	674	108	731	111	766	113
	40	572	114	595	116	623	117	657	118	711	121	745	123
	45	552	126	573	128	600	129	634	130	684	133	715	135
	55	520	153	539	154	566	156	598	157	645	160	673	161
180.4	30	666	107	705	108	763	109	808	111	877	112	923	114
	35	655	117	692	118	748	120	791	122	858	124	902	125
	40	640	129	676	130	730	132	770	133	834	135	876	137
	45	618	144	651	145	702	147	739	148	798	150	837	151
	55	582	179	612	179	656	181	691	182	744	184	779	185
200.4	30	731	117	774	118	838	121	887	123	963	125	1014	127
	35	718	129	759	130	822	132	868	134	941	137	990	139
	40	703	141	742	143	801	145	845	146	915	149	961	151
	45	678	157	715	158	770	160	812	162	876	165	919	166
	55	638	193	670	194	719	196	757	197	815	199	855	201
220.4	30	791	128	837	130	905	132	957	133	1039	136	1093	138
	35	778	141	821	142	890	145	939	146	1017	149	1069	151
	40	762	155	804	157	868	159	915	160	990	163	1040	164
	45	736	173	775	174	834	176	879	178	948	180	994	182
	55	692	214	726	215	780	217	820	218	882	220	924	221
240.4	30	859	140	909	142	982	144	1038	145	1125	147	1183	149
	35	846	155	892	156	964	158	1018	160	1100	162	1156	164
	40	828	170	873	172	941	174	992	175	1071	178	1125	179
	45	799	190	841	192	904	193	952	195	1025	197	1074	199
	55	753	237	790	237	846	239	890	240	957	242	1001	243

kWt = Internal exchanger heating capacity (kW). The data do not consider the part related to the pumps, required to overcome the pressure drop for the solution circulation inside the exchangers.

The kWt heating capacity does not consider any defrosting cycles. For the real heating capacity calculation, including defrosting cycles, please refer to "Integrated heating capacities" table.

kWe = Compressor power input in kW

To = Leaving water temperature user side / hot (°C)

Performance refer to DT = 5°C both cold and heating side.

Cooling performance at part loads

Size	Load	ENTERING WATER TEMPERATURE SOURCE SIDE / HOT (°C)											
		35°C			30°C			25°C			20°C		
		kWf	kWe_tot	EER	kWf	kWe_tot	EER	kWf	kWe_tot	EER	kWf	kWe_tot	EER
70.4	100	206	50,1	4,11	218	45,5	4,79	227	41,2	5,52	236	37,2	6,35
	75	154	36,4	4,24	163	33,1	4,93	171	30,1	5,67	177	27,2	6,51
	50	103	23,1	4,46	109	21,0	5,19	114	19,0	6,00	118	17,0	6,97
	25	51,5	11,5	4,49	54,4	10,4	5,25	56,9	9,26	6,14	59,1	8,10	7,30
	Minimum	47,4	10,6	4,49	49,9	9,47	5,27	51,8	8,40	6,17	53,5	7,25	7,37
75.4	100	219	54,2	4,04	232	49,1	4,71	242	44,5	5,44	251	40,2	6,23
	75	164	39,0	4,21	174	35,5	4,89	181	32,3	5,62	188	29,2	6,44
	50	110	24,6	4,45	116	22,4	5,17	121	20,3	5,97	125	18,1	6,93
	25	54,8	12,2	4,49	57,9	11,0	5,25	60,5	9,88	6,12	62,7	8,63	7,26
	Minimum	47,4	10,6	4,49	49,9	9,47	5,27	51,8	8,40	6,17	53,5	7,25	7,37
80.4	100	235	57,4	4,10	248	52,0	4,77	259	47,1	5,50	268	42,6	6,30
	75	176	41,7	4,23	186	37,9	4,91	194	34,4	5,64	201	31,2	6,44
	50	118	26,6	4,43	124	24,1	5,15	129	21,8	5,94	134	19,6	6,85
	25	58,8	13,1	4,50	62,1	11,8	5,26	64,7	10,6	6,13	67,1	9,26	7,24
	Minimum	47,5	10,5	4,53	50,0	9,41	5,31	51,9	8,33	6,23	53,6	7,19	7,46
85.4	100	255	62,8	4,06	269	56,9	4,73	280	51,6	5,44	291	46,7	6,22
	75	191	45,8	4,17	202	41,6	4,85	210	37,8	5,56	218	34,4	6,34
	50	127	29,0	4,40	134	26,3	5,11	140	23,8	5,89	145	21,4	6,78
	25	63,7	14,2	4,49	67,2	12,9	5,22	70,1	11,5	6,08	72,7	10,1	7,17
	Minimum	47,5	10,5	4,53	50,0	9,46	5,28	51,9	8,38	6,19	53,8	7,24	7,43
90.4	100	274	67,4	4,07	290	61,1	4,75	303	55,3	5,48	313	50,8	6,16
	75	206	48,8	4,22	218	44,2	4,92	227	40,2	5,65	235	37,1	6,33
	50	137	31,6	4,34	145	28,5	5,09	152	25,9	5,85	157	23,8	6,57
	25	68,6	15,6	4,39	72,5	14,1	5,16	75,8	12,7	5,97	78,3	11,5	6,80
	Minimum	47,1	10,6	4,42	49,7	9,50	5,23	51,6	8,46	6,10	53,0	7,53	7,03
100.4	100	301	73,8	4,08	317	67,1	4,73	332	61,3	5,43	345	56,7	6,08
	75	226	53,8	4,20	238	48,9	4,87	249	44,7	5,58	259	41,3	6,26
	50	150	34,5	4,37	159	31,4	5,06	166	28,7	5,79	173	26,4	6,53
	25	75,2	17,1	4,41	79,4	15,5	5,10	83,1	14,2	5,84	86,3	13,1	6,59
	Minimum	60,3	13,6	4,43	63,7	12,4	5,13	66,7	11,4	5,86	69,6	10,5	6,62
110.4	100	331	81,4	4,06	349	74,0	4,72	365	67,4	5,42	377	62,8	6,00
	75	248	59,5	4,17	262	54,1	4,84	274	49,4	5,55	283	45,9	6,16
	50	165	39,3	4,21	175	35,8	4,88	183	32,6	5,60	188	30,4	6,21
	25	82,6	19,1	4,33	87,3	17,4	5,02	91,3	15,9	5,74	94,2	14,8	6,36
	Minimum	75,2	17,3	4,36	79,2	15,7	5,04	82,6	14,3	5,77	85,3	13,3	6,39
120.4	100	375	90,1	4,16	396	81,5	4,86	413	74,3	5,55	428	68,3	6,27
	75	281	64,4	4,37	297	58,2	5,10	310	53,3	5,82	321	48,8	6,58
	50	188	40,4	4,64	198	36,5	5,42	206	33,5	6,16	214	30,7	6,98
	25	101	21,9	4,63	107	19,8	5,41	111	18,1	6,15	116	16,6	6,96
	Minimum	101	21,9	4,63	107	19,8	5,41	111	18,1	6,15	116	16,6	6,96
140.4	100	427	103	4,15	451	93,3	4,83	471	85,4	5,52	488	78,9	6,19
	75	321	73,7	4,35	338	66,7	5,06	353	61,4	5,76	366	56,9	6,44
	50	214	46,3	4,61	225	41,9	5,38	236	38,6	6,10	244	35,7	6,85
	25	107	22,8	4,69	113	20,5	5,49	118	18,8	6,26	122	17,2	7,08
	Minimum	103	21,8	4,70	108	19,7	5,50	113	18,0	6,27	117	16,5	7,10

kWf = Cooling capacity in kW kWe_tot = Overall electrical capacity input by the unit in kW
 Load = % of cooling capacity compared to the value at full load
 Internal exchanger water = leaving 7°C / entering * (variable) / constant flow- rate, equal to nominal value

Cooling performance at part loads

Size	Load	ENTERING WATER TEMPERATURE SOURCE SIDE / HOT (°C)											
		35°C			30°C			25°C			20°C		
		kWf	kWe_tot	EER	kWf	kWe_tot	EER	kWf	kWe_tot	EER	kWf	kWe_tot	EER
160.4	100	477	116	4,13	504	105	4,80	525	96,4	5,45	545	89,5	6,09
	75	358	83,3	4,30	378	75,7	5,00	394	69,6	5,66	409	64,7	6,32
	50	239	52,8	4,52	252	48,0	5,26	263	44,2	5,94	273	41,2	6,62
	25	127	28,2	4,51	134	25,5	5,25	139	23,5	5,93	144	21,9	6,60
	Minimum	127	28,2	4,51	134	25,5	5,25	139	23,5	5,93	144	21,9	6,60
180.4	100	542	130	4,15	570	119	4,81	594	108	5,51	613	98,8	6,20
	75	406	95,0	4,28	427	86,6	4,94	445	78,8	5,65	460	72,3	6,36
	50	271	60,4	4,49	285	55,2	5,16	297	50,3	5,90	306	46,1	6,65
	25	135	29,3	4,62	142	26,8	5,31	148	24,5	6,05	153	22,4	6,84
	Minimum	101	21,3	4,71	106	19,5	5,42	110	17,8	6,17	115	16,4	6,98
200.4	100	595	143	4,17	625	130	4,81	651	119	5,49	671	109	6,15
	75	446	104	4,29	469	94,9	4,94	488	90,5	5,40	504	81,5	6,18
	50	298	66,2	4,49	312	60,5	5,16	326	59,2	5,50	336	52,8	6,36
	25	149	32,7	4,55	156	30,1	5,20	163	28,1	5,79	168	25,9	6,49
	Minimum	126	27,5	4,57	132	25,3	5,21	137	23,2	5,90	143	21,8	6,53
220.4	100	644	157	4,11	676	143	4,74	705	130	5,43	725	119	6,10
	75	483	112	4,31	507	102	4,96	529	93,3	5,66	544	85,6	6,36
	50	322	71,5	4,51	338	65,3	5,18	352	59,9	5,88	363	55,0	6,59
	25	161	35,0	4,60	169	32,1	5,26	176	29,6	5,95	181	27,3	6,64
	Minimum	128	27,6	4,64	134	25,3	5,30	139	23,3	5,98	144	21,7	6,65
240.4	100	698	172	4,06	733	156	4,70	764	142	5,39	786	129	6,07
	75	523	124	4,23	550	113	4,89	573	102	5,60	589	93,6	6,30
	50	349	78,2	4,46	367	71,3	5,14	382	65,0	5,87	393	59,4	6,61
	25	184	41,2	4,46	192	37,5	5,13	200	34,0	5,87	205	31,1	6,60
	Minimum	184	41,2	4,46	192	37,5	5,13	200	34,0	5,87	205	31,1	6,60

kWf = Cooling capacity in kW

kWe_tot = Overall electrical capacity input by the unit in kW

Load = % of cooling capacity compared to the value at full load

Internal exchanger water = leaving 7°C / entering * (variable) / constant flow- rate, equal to nominal value

Configurations

B - Low water temperature (Brine)

Composed of suitable brazed plate heat exchanger closed-cell insulation 13mm thick, electronic expansion valve, functional calibration and safety devices suitable for particular uses. Enables an “unfreezable” solution to be cooled (for example, water and ethylene glycol in suitable quantities) up to a temperature of between +4°C and -8°C. Configuration also known as “Brine”. It includes:

- suitable exchangers with extra-thick closed-cell insulation
- electronic expansion valve, functional calibration and safety devices suitable for particular uses.

The unit in this configuration has a different operation range, indicated in the operating range section.

The glycol concentration must be chosen based on the minimum temperature the water can reach. The presence of glycol influences pressure drops on the water side and the unit's output as indicated in the table reporting the “correction factors for use with glycol”.

D - Partial energy recovery

Consisting of heat exchanger of a brazed plate heat exchanger made of 316 stainless steel, suitable for recovering a part of the capacity dispersed by the unit. Maximum operating pressure exchanger: 10 bar on the water side and 45 bar on the refrigerant side. A configuration which enables the production of hot water free-of-charge while operating in the cooling mode, thanks to the total recovery of condensation heat that would otherwise be disposed of into the external heat source. This option is also known as “desuperheater”. The partial recovery device is considered to be operating when it is powered by the water flow which is to be heated. This condition improves the unit performance. When the temperature of the water to be heated is particularly low, it is necessary to insert a flow regulation valve in the hydraulic circuit (user side), to maintain the recovery output temperature at higher than 35°C and thus avoid refrigerant condensation in the plate exchanger.

The power delivered by the partial recovery is 25% of the thermal power dissipation (cooling + electrical power absorbed by the compressors)

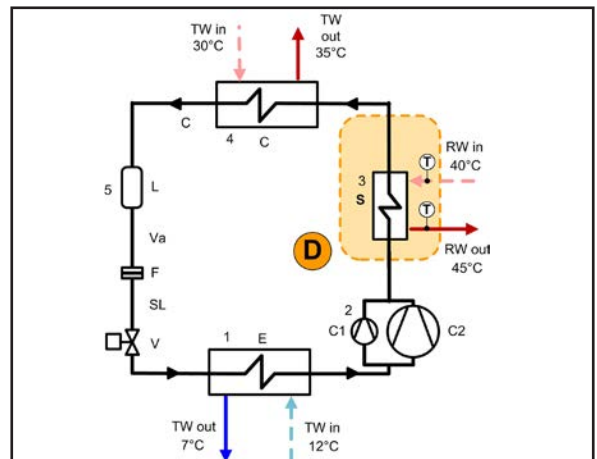

D - Partial recovery device
 TW in chilled water inlet
 TW out chilled water outlet
 1 - Internal exchanger
 2 - Compressors
 3 - Recovery exchanger (D)
 4 - External exchanger
 5 - Expansion electronic valve
 RW in - Recovery water input
 RW out - Recovery water output
 T - Temperature probe

Partial recovery heating capacity

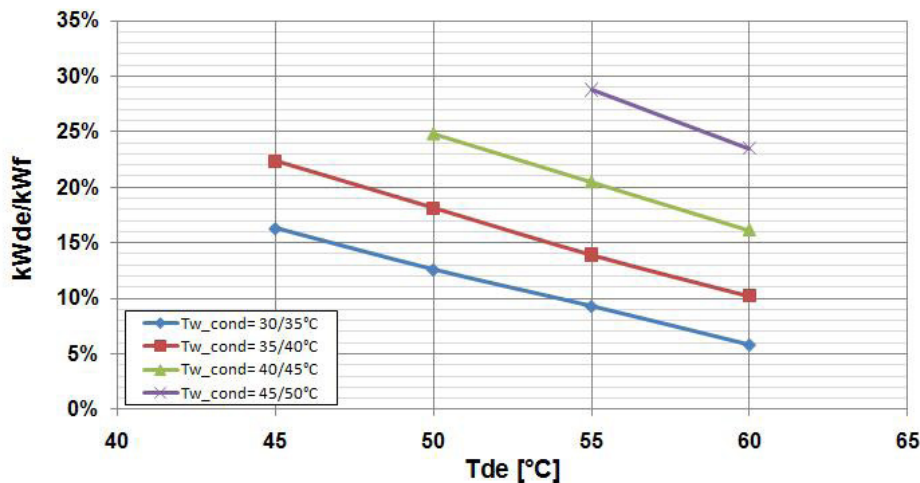

kWde/kWf = Heating capacity/cooling capacity [%]
 Tde = Leaving recovery exchanger water temperature [°C]
 Leaving exchanger water temperature user side = 7°C [°C]

Efficient use of energy with heat recovery

In almost all systems fitted with a chiller used to produce chilled water there is also the need to have hot water. The recovery of condensation heat is an efficient way of producing hot water while the chiller is in operation. It has the double benefit of both reducing the heat load to the condenser, thereby eliminating dissipation costs and generating free hot water, thereby reducing the costs of the auxiliary heater.

Application versatility of recovery devices

The hot water produced by heat recovery can be used in a number of ways: to reheat air in handling units, to preheat hot water for domestic use or industrial processes, to heat up water in swimming pools, showers and spas, to preheat hot water for laundries or industrial kitchens.



Post-heating in air handling units to control humidity levels in hospitals and labs



Preheating of hot water for domestic use or for industrial process



Heating of water in swimming pools, showers and SPAS



Preheating of hot water for laundries and industrial kitchens

Air heating

The heat recovery device can be used to cover the entire heat load required. The hot water supply temperature is controlled via a modulating control valve that needs to be fitted on the system at the outlet of the recovery unit. The auxiliary heating device is recommended to cover the thermal energy demand when the chiller is not in operation or is operating at part load.

Example of how heat recovery is used to cover the entire heat demand and control the operating temperature

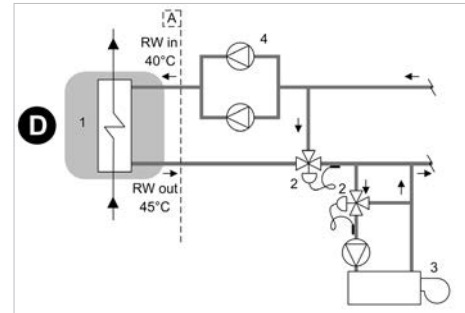

Water preheating

The heat recovery device can be used to preheat water at the inlet of the main heating device (e.g. boiler). In this case, the demand for hot water is greater than the amount of heat recovered by condensation and the recovery device only covers part of the required heat load. By preheating the water, heating consumption levels are therefore reduced and the main heating device has a lower installed power requirement.

Example of how heat recovery is used to preheat hot water in the system

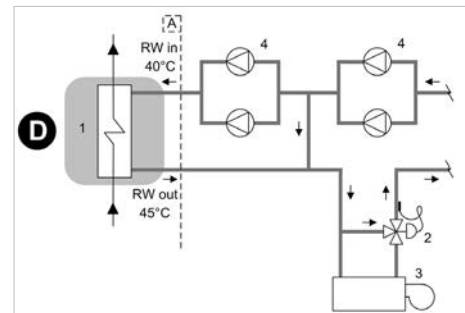

Domestic hot water production

The heat recovery device can be used to produce water for domestic use. In order to prevent contamination of domestic water with the chiller's process fluid, it is necessary to insert an intermediate heat exchanger. Using an inertial heat storage tank allows to have a reserve of preheated water and enables the intermediate exchanger to operate more efficiently.

Example of how heat recovery is used to preheat hot water for domestic use

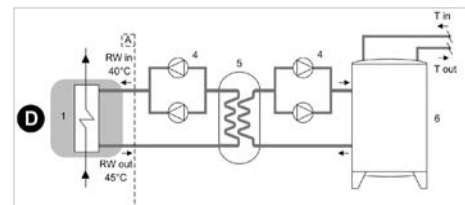

- A - Unit supply limit
- 1 - Recovery exchanger
- 3 - Auxiliary heating device (ex.boiler)
- 5 - Intermediate heat exchanger
- RW in - Recovery water input
- T in - Drinkable water inlet

- D - Partial energy recovery
- 2 - Control modulating valve
- 4 - Electric pump with standby pump
- 6 - Inertial heat storage
- RW out - Recovery water output
- T out - Drinkable water outlet to the auxiliary heater

The diagrams refer to partial energy recovery, though they also apply to total energy recovery (Clivet R). Please note that the diagrams are only meant as a guide.

Hydronic assemblies - heating side

VARYH - VARYFLOW+ (heating side 2 inverter pumps)

Configuration with 2 centrifugal electric pumps arranged in parallel and controlled by inverter, with housing and impeller made with AISI 304 stainless steel, and components as described on the water diagram key. All water fittings are Victaulic type.

The electric pumps are equipped with three-phase electric motor with IP55-protection and complete with thermoformed insulated casing.

The control, modulates the water flow-rate keeping constant the delta T. If the water temperature is in critical conditions, it allows to extend the unit operating ranges guaranteeing its operating, automatically reducing the water flow-rate. In the event of one of the two pumps is temporarily unavailable, it guarantees about the 80% of the nominal flow-rate.

Head (Size 70.4 ÷ 85.4)

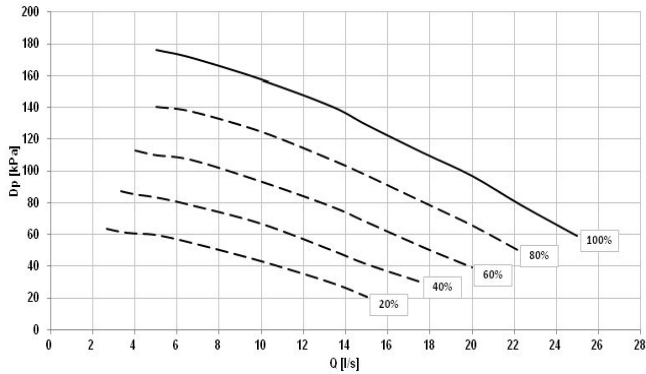

Q = Water flow rate [l/s] Dp = Head [kPa]

Absorption curves (Size 70.4 ÷ 85.4)

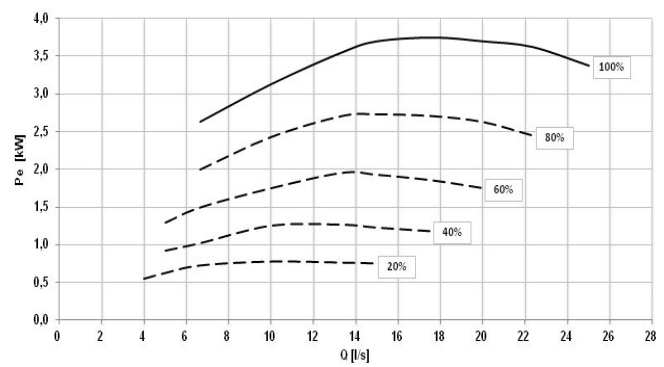

Q = Water flow rate [l/s] Pe = Power input[kW]

Head (Size 90.4 ÷ 110.4)

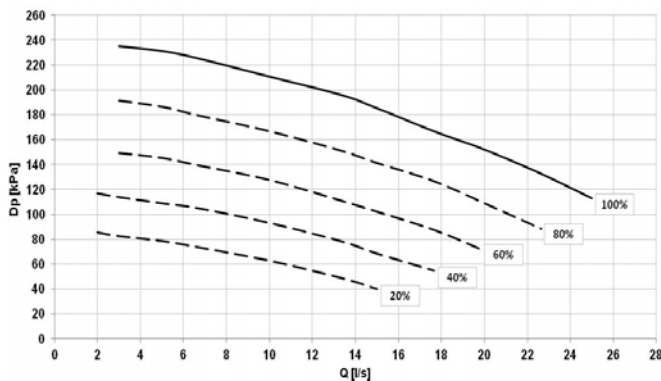

Q = Water flow rate [l/s] Dp = Head [kPa]

Absorption curves (Size 90.4 ÷ 110.4)

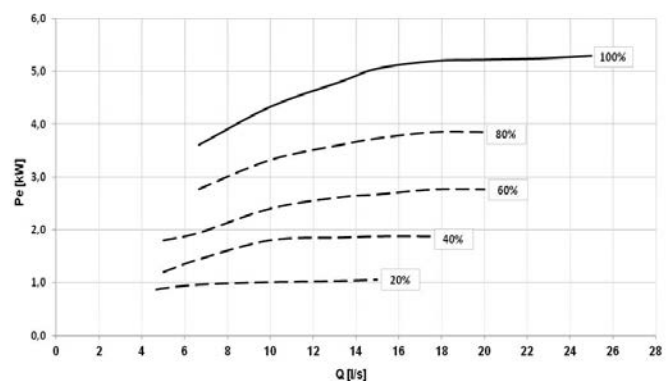

Q = Water flow rate [l/s] Pe = Power input[kW]

Head (Size 120.4 ÷ 160.4)

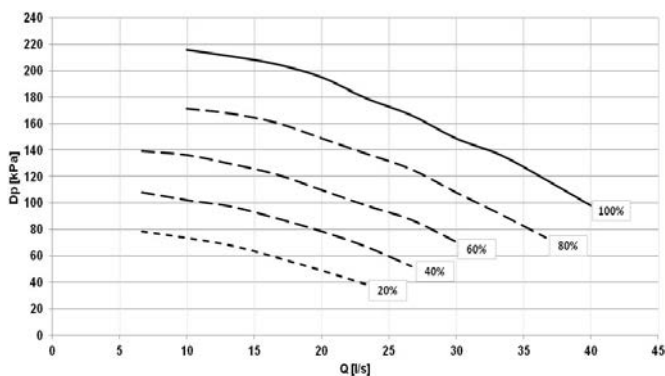

Q = Water flow rate [l/s] Dp = Head [kPa]

Absorption curves (Size 120.4 ÷ 160.4)

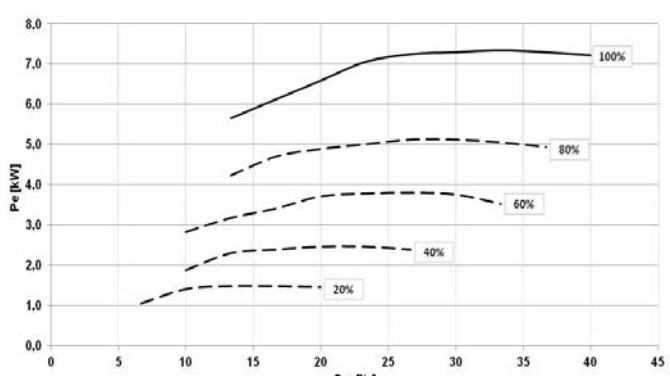

Q = Water flow rate [l/s] Pe = Power input[kW]



Caution: to obtain the available pressure values, you need to subtract the following from the head values represented in these diagrams:

- internal exchanger pressure drops
- IFVX accessory –Steel mesh filter on the water side (where applicable)

Hydronic assemblies - heating side

VARYH - VARYFLOW+ (heating side 2 inverter pumps)

Head (Size 180.4 ÷ 240.4)

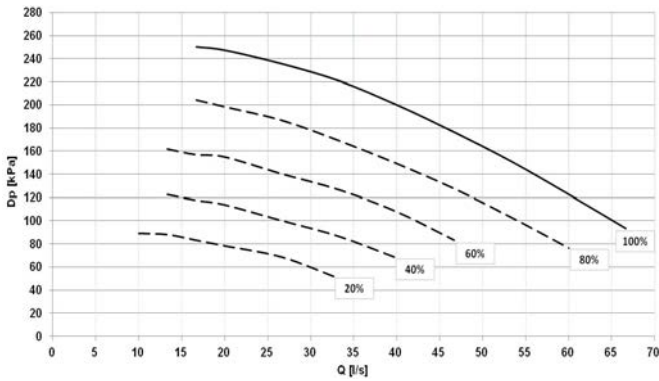

Q = Water flow rate [l/s] Dp = Head [kPa]

Absorption curves (Size 180.4 ÷ 240.4)

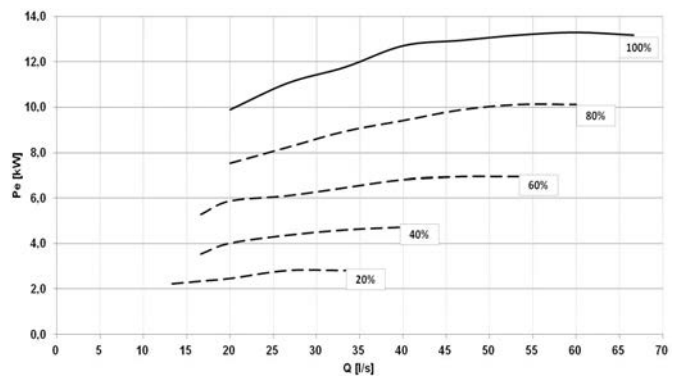

Q = Water flow rate [l/s] Pe = Power input [kW]



Caution: to obtain the available pressure values, you need to subtract the following from the head values represented in these diagrams:

- internal exchanger pressure drops
- IFVX accessory –Steel mesh filter on the water side (where applicable)

Water diagram

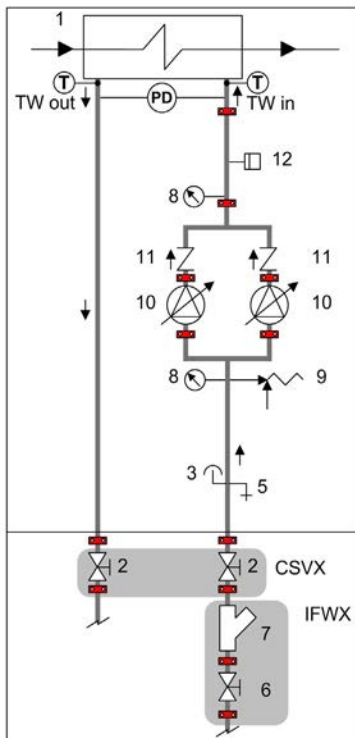

- 1 - Internal exchanger
- 2 - Cutoff valve
- 3 - Purge valve
- 5 - Drain valve
- 6 - Cutoff valve with quick joints
- 7 - Steel mesh strainer water side
- 8 - Manometer
- 9 - Safety valve (6 Bar)
- 10 - Packaged electric pump with high efficiency impeller activated by inverter
- 11 - Non return valve
- 12 - System safety pressure switch (prevents the pumps from operating if no water is present)

T - Temperature probe
PD - Differential pressure switch

TW in chilled water inlet
TW out chilled water outlet

IFWX = Steel mesh strainer on the water side
CSVX = Couple of manually operated shut-off valves

The grey area indicates further optional components.

Hydronic assemblies - heating side

HYGH1 - Heating side hydronic assembly with 1 ON/OFF pump

Configuration with 1 centrifugal electric pump, with housing and impeller made with AISI 304 stainless steel, and components as described on the water diagram key. All water fittings are Victaulic type.

The electric pump is equipped with three-phase electric motor with IP55-protection and complete with thermoformed insulated casing.

Head (Size 70.4 ÷ 240.4)

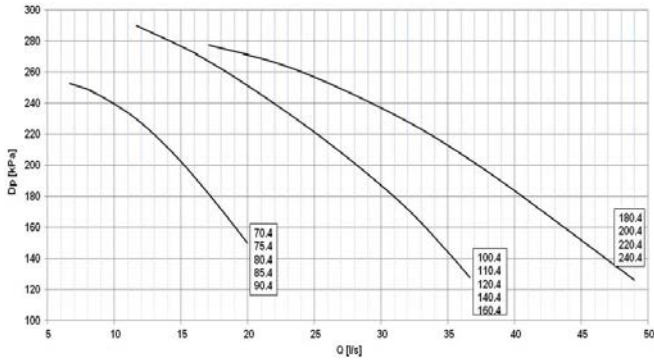

Q = Water flow rate [l/s] Dp = Head [kPa]

Absorption curves (Size 70.4 ÷ 240.4)

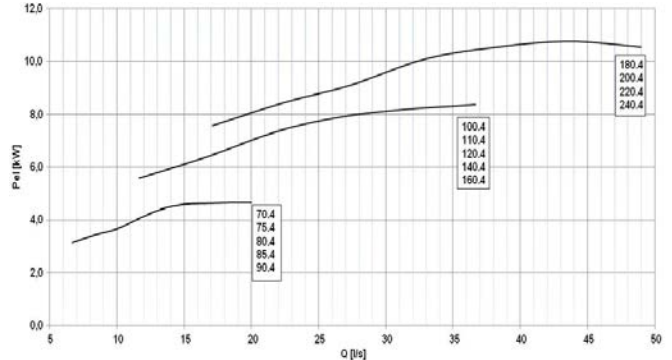

Q = Water flow rate [l/s] Pe = Power input [kW]

Caution: to obtain the available pressure values, you need to subtract the following from the head values represented in these diagrams:



- internal exchanger pressure drops
- IFVX accessory –Steel mesh filter on the water side (where applicable)

Water diagram

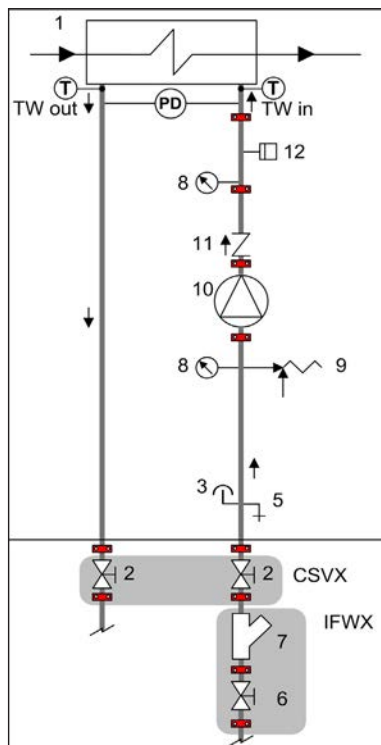

- 1 - Internal exchanger
- 2 - Cutoff valve
- 3 - Purge valve
- 5 - Drain valve
- 6 - Cutoff valve with quick joints
- 7 - Steel mesh strainer water side
- 8 - Manometer
- 9 - Safety valve (6 Bar)
- 10 - Packaged electric pump with high efficiency impeller
- 11 - Non return valve
- 12 - System safety pressure switch (prevents the pumps from operating if no water is present)

T - Temperature probe
PD - Differential pressure switch

TW in chilled water inlet
TW out chilled water outlet

IFWX = Steel mesh strainer on the water side
CSVX = Couple of manually operated shut-off valves

The grey area indicates further optional components.

Hydronic assemblies - heating side

HYGH2 - Heating side hydronic assembly with 2 ON/OFF pumps

Configuration with 2 centrifugal electric pumps, 1 stand-by, with housing and impeller made with AISI 304 stainless steel, and components as described on the water diagram key. All water fittings are Victaulic type.

The electric pumps are equipped with three-phase electric motor with IP55-protection and complete with thermoformed insulated casing.

The control balances the operating hours and in case of failure it is signaled and the stand-by pump is automatically activated.

Head (Size 70.4 ÷ 240.4)

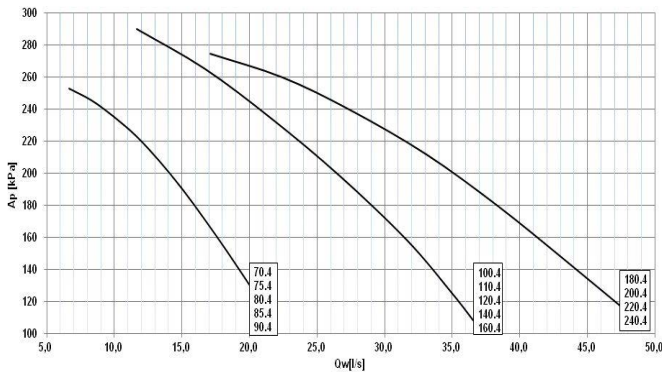

Q = Water flow rate [l/s] Dp = Head [kPa]

Absorption curves (Size 70.4 ÷ 240.4)

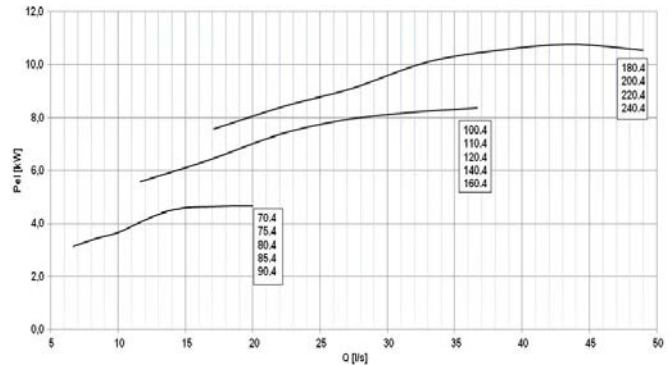

Q = Water flow rate [l/s] Pe = Power input [kW]



Caution: to obtain the available pressure values, you need to subtract the following from the head values represented in these diagrams:

- internal exchanger pressure drops
- IFVX accessory –Steel mesh filter on the water side (where applicable)

Water diagram

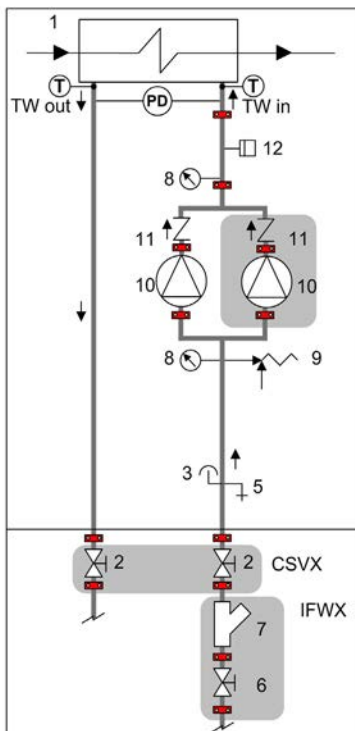

- 1 - Internal exchanger
- 2 - Cutoff valve
- 3 - Purge valve
- 5 - Drain valve
- 6 - Cutoff valve with quick joints
- 7 - Steel mesh strainer water side
- 8 - Manometer
- 9 - Safety valve (6 Bar)
- 10 - Packaged electric pump with high efficiency impeller
- 11 - Non return valve
- 12 - System safety pressure switch (prevents the pumps from operating if no water is present)
- 13 - Antifreeze heater

T - Temperature probe
PD - Differential pressure switch

TW in chilled water inlet
TW out chilled water outlet

IFWX = Steel mesh strainer on the water side
CSVX = Couple of manually operated shut-off valves

The grey area indicates further optional components.

Hydronic assemblies - heating side

2PMH - Hydropack heating side with 2 pumps

Pumping unit supplied on the unit consisting of 2 parallel electric pumps (all in duty) with a self-adaptive modular activation logic.

Centrifugal electric pump with impeller made with AISI 304 steel and AISI 304 stainless steel body or grey cast iron (depending on models). Mechanical seal using ceramic, carbon and EPDM elastomer components.

Three-phase electric motor with IP55 protection and class F insulation. Complete with thermoformed insulated casing, Victaulic type quick connections with insulated casing, non return valve, safety valve (6 bar), pressure gauges, system load safety pressure switch, stainless steel antifreeze immersion heaters located at the return and supply point.



The HYP2S option is supplied with a kit made up of 2 quick blind connections, for the removal of one pump in case of maintenance.



Provided with hydraulic interceptions to the outside of the unit (option 'CSVX - A pair of manually operated shut-off valves') to facilitate any major maintenance

Head (Size 70.4 ÷ 240.4)

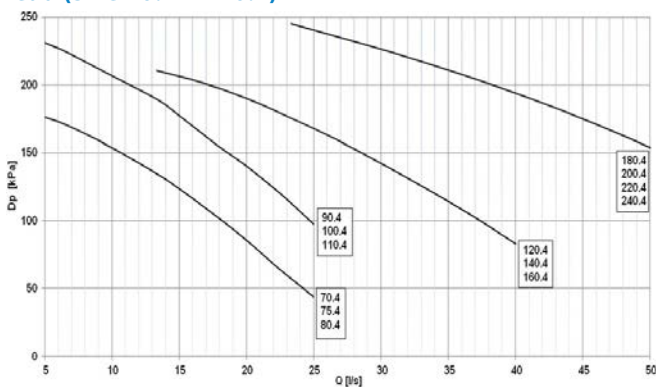

Q = Water flow rate [l/s] Dp = Head [kPa]

Absorption curves (Size 70.4 ÷ 240.4)

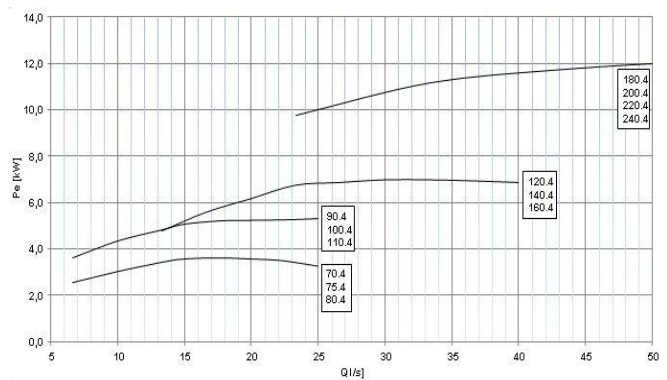

Q = Water flow rate [l/s] Pe = Power input [kW]



Caution: to obtain the available pressure values, you need to subtract the following from the head values represented in these diagrams:

- internal exchanger pressure drops
- IFVX accessory –Steel mesh filter on the water side (where applicable)

Water diagram

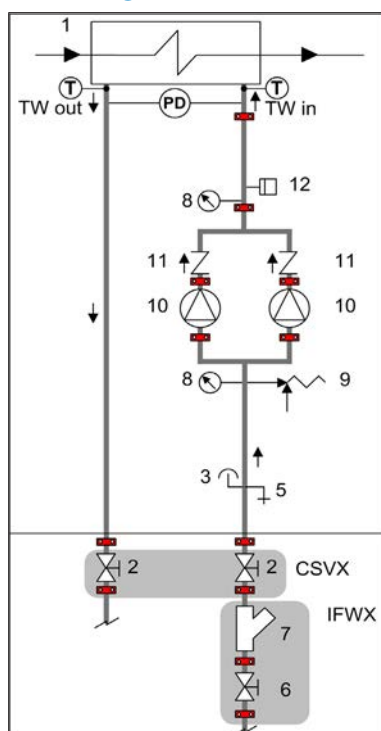

- 1 - Internal exchanger
- 2 - Cutoff valve
- 3 - Purge valve
- 5 - Drain valve
- 6 - Cutoff valve with quick joints
- 7 - Steel mesh strainer water side
- 8 - Manometer
- 9 - Safety valve (6 Bar)
- 10 - Packaged electric pump with high efficiency impeller
- 11 - Non return valve
- 12 - System safety pressure switch (prevents the pumps from operating if no water is present)

T - Temperature probe
PD - Differential pressure switch

TW in chilled water inlet
TW out chilled water outlet

IFWX = Steel mesh strainer on the water side
CSVX = Couple of manually operated shut-off valves

The grey area indicates further optional components.

Hydronic assemblies - heating side

VS2MH - Heating side 2-way modulating valve

Configuration with 1 globe modulating 2-way valve, equal-percentage source side and components according to the key indicated on the water diagram. All water fittings are Victaulic type.

The valve is suitable for pressure difference up to 2 bar for size from 70.4 to 110.4 and up to 1,5 bar for size from 120.4 to 240.4.

The 2-way source side modulating valve, installed on the source side exchanger inlet, modulates the flow of water in response to a 0-10 V signal from the unit's controller.

Heating side 2-way modulating valve pressure drops

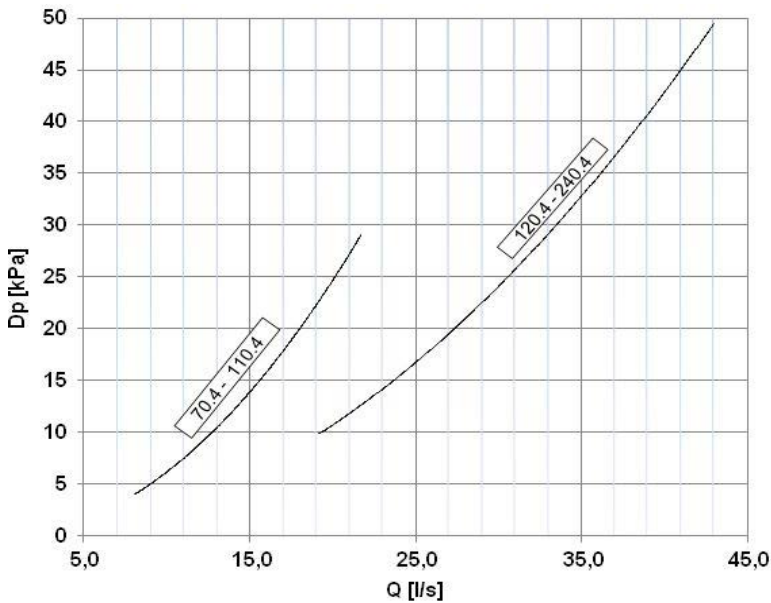

The pressure drops, water side, are calculated considering an average water temperature of 7°C.

Q = Water flow rate [l/s]
DP = Pressure drops [kPa]

Max opening DP	[bar]	2	2	2	2	2	2	2	1,5	1,5	1,5	1,5	1,5	1,5	1,5
Max. seeping	[l/min]	2,4	2,4	2,4	2,4	2,4	2,4	2,4	3,7	3,7	3,7	3,7	3,7	3,7	3,7
Diameter		4"	4"	4"	4"	4"	4"	4"	5"	5"	5"	5"	5"	5"	5"

Water diagram

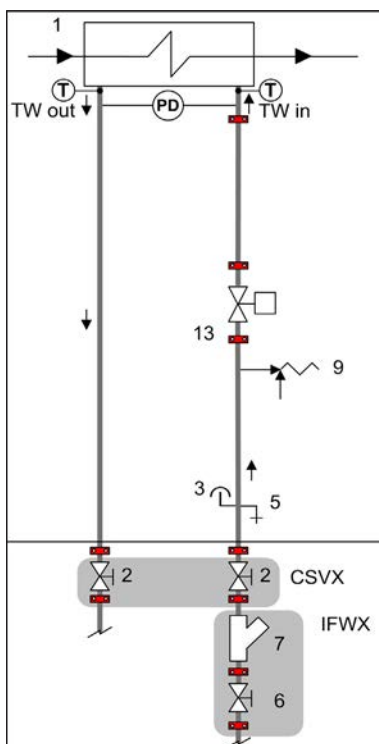

- 1 - Internal exchanger
- 2 - Cutoff valve
- 3 - Purge valve
- 5 - Draw off cock
- 6 - Cutoff valve with quick joints
- 7 - Steel mesh strainer water side
- 9 - Safety valve (6 Bar)
- 13 - 2-way modulating valve

T - Temperature probe
PD - Differential pressure switch

TW in chilled water inlet
TW out chilled water outlet

IFWX = Steel mesh strainer on the water side
CSVX = Couple of manually operated shut-off valves

The grey area indicates further optional components.

Hydronic assemblies - heating side

V2MHP - Heating side 2-way modulating valve for high DP

Configuration with 1 ball modulating 2-way valve, equal-percentage source side and components according to the key indicated on the water diagram. All water fittings are Victaulic type.

The valve is suitable for pressure difference up to 4 bar and guarantees a seeping equal to 0.

The 2-way source side modulating valve, installed on the source side exchanger inlet, modulates the flow of water in response to a 0-10 V signal from the unit's controller.

Heating side 2-way modulating valve pressure drops for high DP

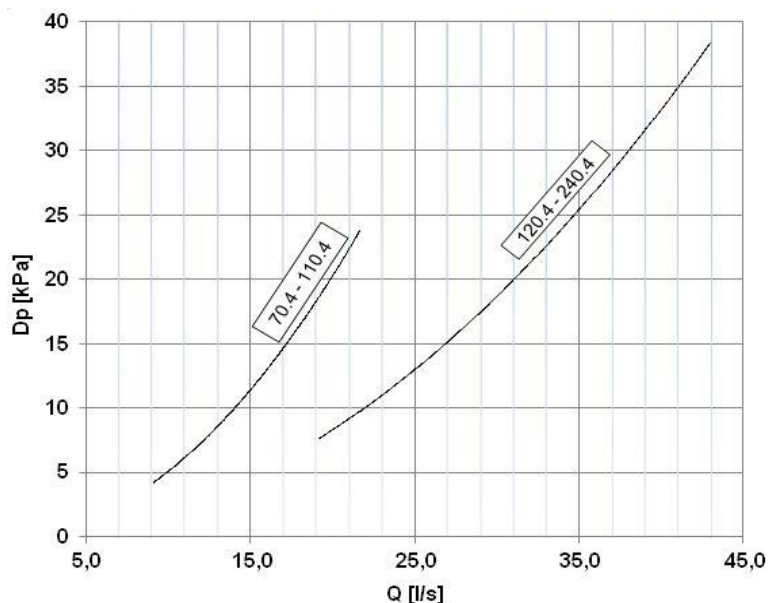

The pressure drops, water side, are calculated considering an average water temperature of 7°C.

Q = Water flow rate [l/s]
DP = Pressure drops [kPa]

Max opening DP	[bar]	4	4	4	4	4	4	4	4	4	4	4	4	4	4
Max. seeping	[l/min]	0	0	0	0	0	0	0	0	0	0	0	0	0	0
Diameter		4"	4"	4"	4"	4"	4"	4"	4"	5"	5"	5"	5"	5"	5"

Water diagram

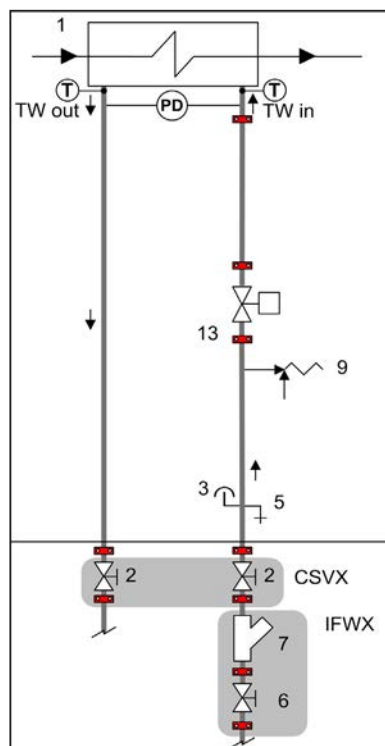

- 1 - Internal exchanger
- 2 - Cutoff valve
- 3 - Purge valve
- 5 - Drain valve
- 6 - Cutoff valve with quick joints
- 7 - Steel mesh strainer water side
- 9 - Safety valve (6 Bar)
- 13 - 2-way modulating valve for high DP

T - Temperature probe
PD - Differential pressure switch

TW in chilled water inlet
TW out chilled water outlet

IFWX = Steel mesh strainer on the water side
CSVX = Couple of manually operated shut-off valves

The grey area indicates further optional components.

Hydronic assemblies - Cooling side

VARYC - VARYFLOW+ (heating side 2 inverter pumps)

Configuration with 2 centrifugal electric pumps arranged in parallel and controlled by inverter, with housing and impeller made with AISI 304 stainless steel, and components as described on the water diagram key. All water fittings are Victaulic type.

The electric pumps are equipped with three-phase electric motor with IP55-protection and complete with thermoformed insulated casing.

The control, modulates the water flow-rate keeping constant the delta T. If the water temperature is in critical conditions, it allows to extend the unit operating ranges guaranteeing its operating, automatically reducing the water flow-rate. In the event of one of the two pumps is temporarily unavailable, it guarantees about the 80% of the nominal flow-rate.

Head (Size 70.4 ÷ 85.4)

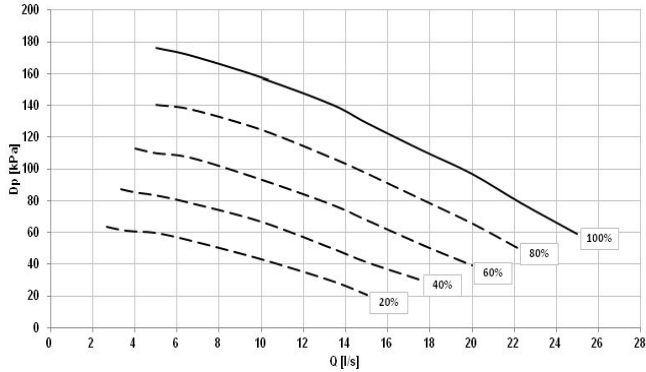

Q = Water flow rate [l/s] Dp = Head kPa

Absorption curves (Size 70.4 ÷ 85.4)

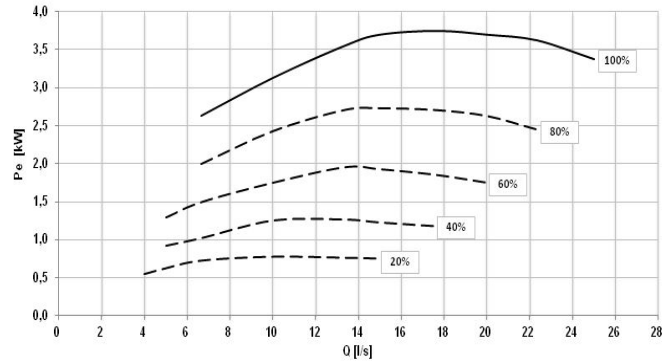

Q = Water flow rate [l/s] Pe = Power input[kW]

Head (Size 90.4 ÷ 110.4)

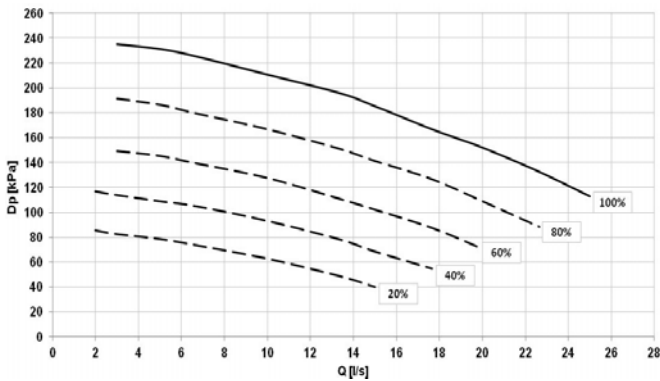

Q = Water flow rate [l/s] Dp = Head kPa

Absorption curves (Size 90.4 ÷ 110.4)

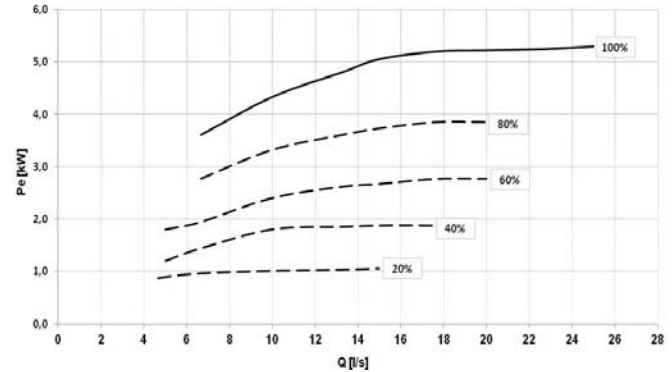

Q = Water flow rate [l/s] Pe = Power input[kW]

Head (Size 120.4 ÷ 160.4)

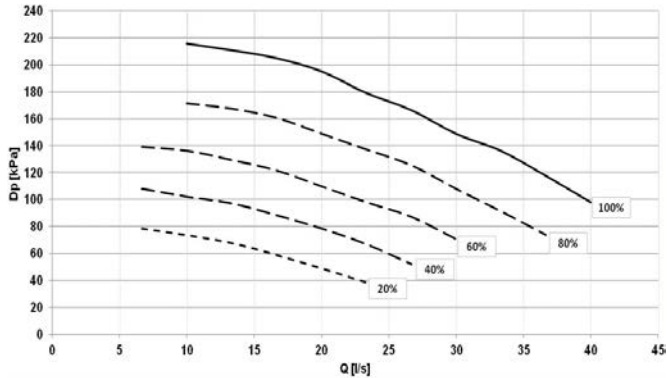

Q = Water flow rate [l/s] Dp = Head kPa

Absorption curves (Size 120.4 ÷ 160.4)

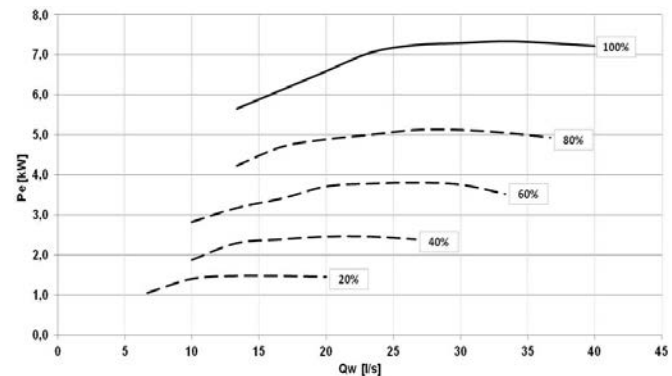

Q = Water flow rate [l/s] Pe = Power input[kW]



Caution: to obtain the available pressure values, you need to subtract the following from the head values represented in these diagrams:

- internal exchanger pressure drops
- IFVX accessory –Steel mesh filter on the water side (where applicable)

Hydronic assemblies - Cooling side

VARYC - VARYFLOW+ (heating side 2 inverter pumps)

Head (Size 180.4 ÷ 240.4)

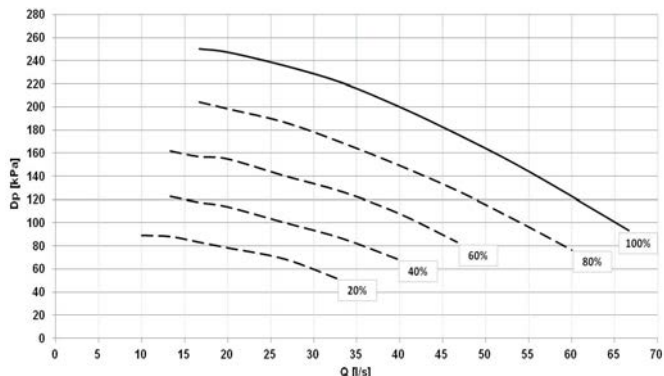

Q = Water flow rate [l/s] Dp = Head [kPa]

Absorption curves (Size 180.4 ÷ 240.4)

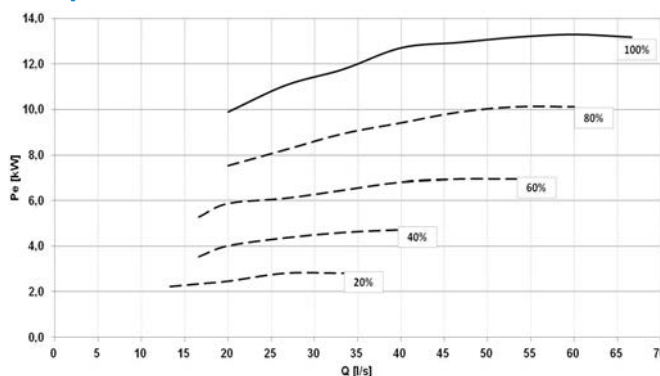

Q = Water flow rate [l/s] Pe = Power input [kW]

Caution: to obtain the available pressure values, you need to subtract the following from the head values represented in these diagrams:



- internal exchanger pressure drops
- IFVX accessory –Steel mesh filter on the water side (where applicable)

Water diagram

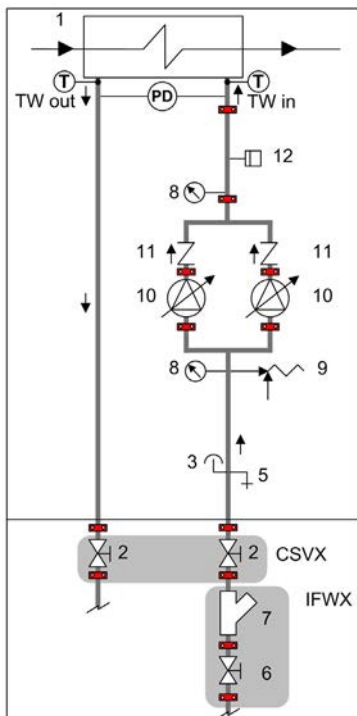

- 1 - Internal exchanger
- 2 - Cutoff valve
- 3 - Purge valve
- 5 - Drain valve
- 6 - Cutoff valve with quick joints
- 7 - Steel mesh strainer water side
- 8 - Manometer
- 9 - Safety valve (6 Bar)
- 10 - Packaged electric pump with high efficiency impeller activated by inverter
- 11 - Non return valve
- 12 - System safety pressure switch (prevents the pumps from operating if no water is present)

T - Temperature probe
PD - Differential pressure switch

TW in chilled water inlet
TW out chilled water outlet

IFWX = Steel mesh strainer on the water side
CSVX = Couple of manually operated shut-off valves

The grey area indicates further optional components.

Hydronic assemblies - Cooling side

HYGC1 - Cooling side hydronic assembly with 1 ON/OFF pump

Configuration with 1 centrifugal electric pump, with housing and impeller made with AISI 304 stainless steel, and components as described on the water diagram key. All water fittings are Victaulic type.

The electric pump is equipped with three-phase electric motor with IP55-protection and complete with thermoformed insulated casing.

Head (Size 70.4 ÷ 240.4)

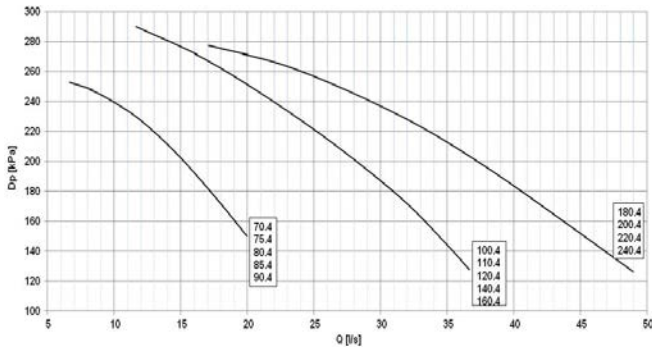

Q = Water flow rate [l/s] Dp = Head [kPa]

Absorption curves (Size 70.4 ÷ 240.4)

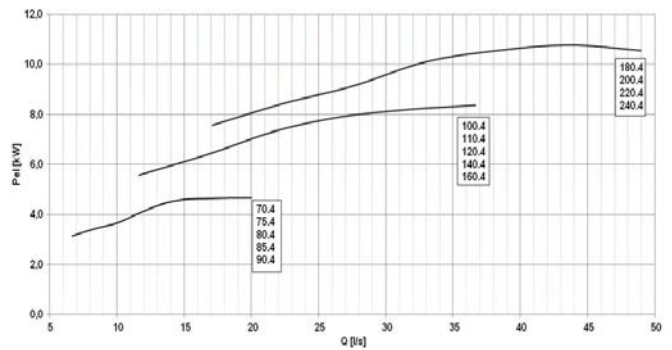

Q = Water flow rate [l/s] Pe = Power input[kW]



Caution: to obtain the available pressure values, you need to subtract the following from the head values represented in these diagrams:

- internal exchanger pressure drops
- IFWX accessory –Steel mesh filter on the water side (where applicable)

Water diagram

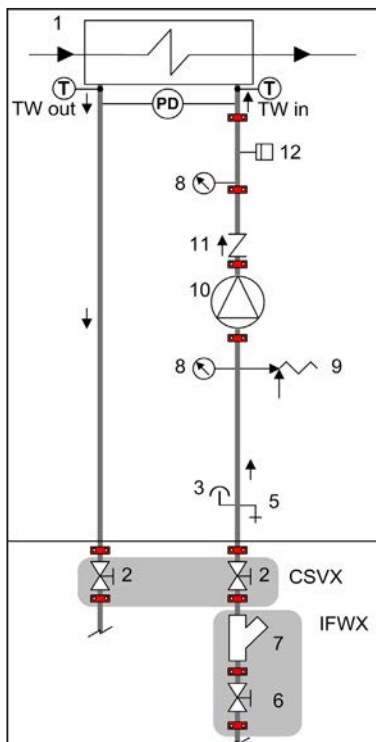

- 1 - Internal exchanger
- 2 - Cutoff valve
- 3 - Purge valve
- 5 - Drain valve
- 6 - Cutoff valve with quick joints
- 7 - Steel mesh strainer water side
- 8 - Manometer
- 9 - Safety valve (6 Bar)
- 10 - Packaged electric pump with high efficiency impeller
- 11 - Non return valve
- 12 - System safety pressure switch (prevents the pumps from operating if no water is present)

T - Temperature probe
PD - Differential pressure switch

TW in chilled water inlet
TW out chilled water outlet

IFWX = Steel mesh strainer on the water side
CSVX = Couple of manually operated shut-off valves

The grey area indicates further optional components.

Hydronic assemblies - Cooling side

HYGC2 - Cooling side hydronic assembly with 2 ON/OFF pumps

Configuration with 2 centrifugal electric pumps, 1 stand-by, with housing and impeller made with AISI 304 stainless steel, and components as described on the water diagram key. All water fittings are Victaulic type.

The electric pumps are equipped with three-phase electric motor with IP55-protection and complete with thermoformed insulated casing.

The control balances the operating hours and in case of failure it is signaled and the stand-by pump is automatically activated.

Head (Size 70.4 ÷ 240.4)

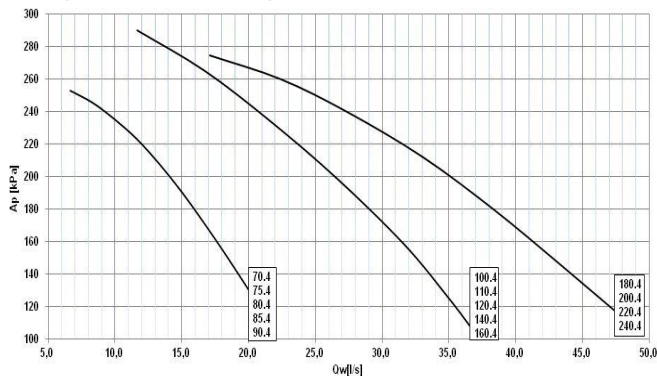

Q = Water flow rate [l/s] Dp = Head [kPa]

Absorption curves (Size 70.4 ÷ 240.4)

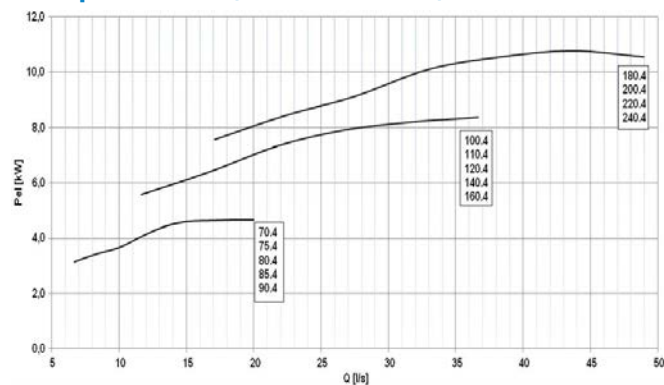

Q = Water flow rate [l/s] Pe = Power input [kW]



Caution: to obtain the available pressure values, you need to subtract the following from the head values represented in these diagrams:

- internal exchanger pressure drops
- IFVX accessory –Steel mesh filter on the water side (where applicable)

Water diagram

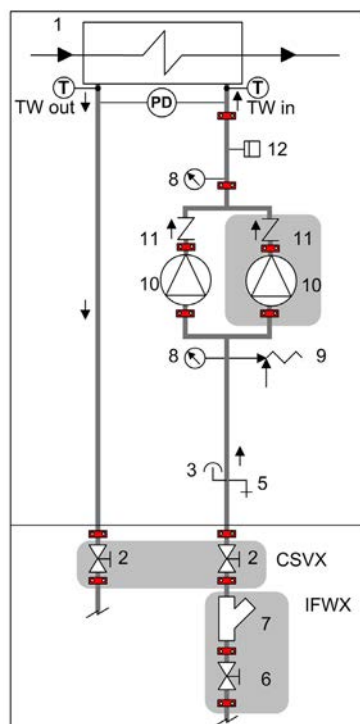

- 1 - Internal exchanger
- 2 - Cutoff valve
- 3 - Purge valve
- 5 - Drain valve
- 6 - Cutoff valve with quick joints
- 7 - Steel mesh strainer water side
- 8 - Manometer
- 9 - Safety valve (6 Bar)
- 10 - Packaged electric pump with high efficiency impeller
- 11 - Non return valve
- 12 - System safety pressure switch (prevents the pumps from operating if no water is present)

T - Temperature probe
PD - Differential pressure switch

TW in chilled water inlet
TW out chilled water outlet

IFWX = Steel mesh strainer on the water side
CSVX = Couple of manually operated shut-off valves

The grey area indicates further optional components.

Hydronic assemblies - Cooling side

2PMC - Hydropack cooling side with 2 pumps

Pumping unit supplied on the unit consisting of 2 parallel electric pumps (all in duty) with a self-adaptive modular activation logic.

Centrifugal electric pump with impeller made with AISI 304 steel and AISI 304 stainless steel body or grey cast iron (depending on models). Mechanical seal using ceramic, carbon and EPDM elastomer components.

Three-phase electric motor with IP55 protection and class F insulation. Complete with thermoformed insulated casing, Victaulic type quick connections with insulated casing, non return valve, safety valve (6 bar), pressure gauges, system load safety pressure switch, stainless steel antifreeze immersion heaters located at the return and supply point.



The HYP2S option is supplied with a kit made up of 2 quick blind connections, for the removal of one pump in case of maintenance.



Provided with hydraulic interceptions to the outside of the unit (option 'CSVX - A pair of manually operated shut-off valves') to facilitate any major maintenance

Head (Size 70.4 ÷ 240.4)

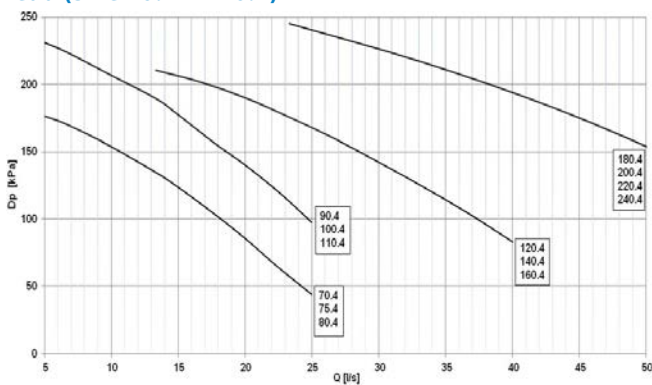

Q = Water flow rate [l/s] Dp = Head [kPa]

Absorption curves (Size 70.4 ÷ 240.4)

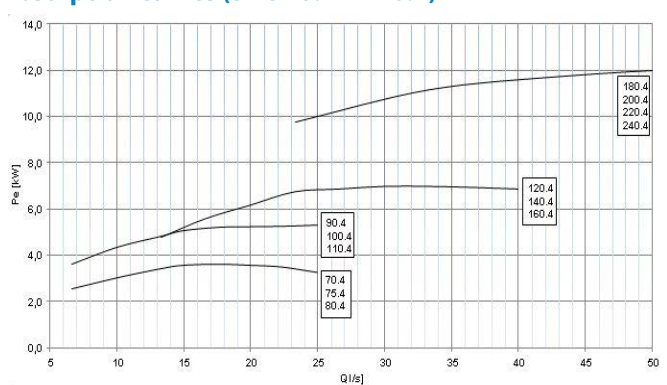

Q = Water flow rate [l/s] Pe = Power input[kW]



Caution: to obtain the available pressure values, you need to subtract the following from the head values represented in these diagrams:

- internal exchanger pressure drops
- IFVX accessory –Steel mesh filter on the water side (where applicable)

Water diagram

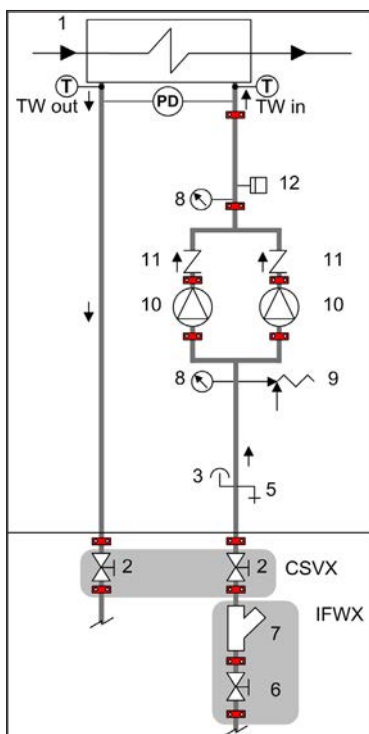

- 1 - Internal exchanger
- 2 - Cutoff valve
- 3 - Purge valve
- 5 - Draw off cock
- 6 - Cutoff valve with quick joints
- 7 - Steel mesh strainer water side
- 8 - Manometer
- 9 - Safety valve (6 Bar)
- 10 - Packaged electric pump with high efficiency impeller
- 11 - Non return valve
- 12 - System safety pressure switch (prevents the pumps from operating if no water is present)

T - Temperature probe
PD - Differential pressure switch

TW in chilled water inlet
TW out chilled water outlet

IFWX = Steel mesh strainer on the water side
CSVX = Couple of manually operated shut-off valves

The grey area indicates further optional components.

Hydronic assemblies - Cooling side

VS2MC - Cooling side 2-way modulating valve

Configuration with 1 globe modulating 2-way valve, equal-percentage source side and components according to the key indicated on the water diagram. All water fittings are Victaulic type.

The valve is suitable for pressure difference up to 2 bar for size from 70.4 to 110.4 and up to 1,5 bar for size from 120.4 to 240.4.

The 2-way source side modulating valve, installed on the source side exchanger inlet, modulates the flow of water in response to a 0-10 V signal from the unit's controller.

2-way modulating valve pressure drops

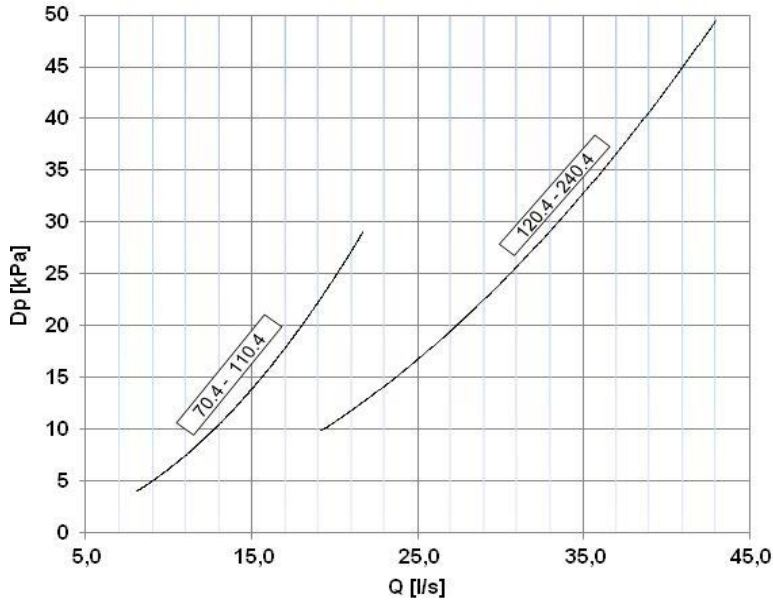

The pressure drops, water side, are calculated considering an average water temperature of 7°C.

Q = Water flow rate [l/s]
DP = Pressure drops [kPa]

Max opening DP	[bar]	2	2	2	2	2	2	2	2	1,5	1,5	1,5	1,5	1,5	1,5	1,5
Max. seeping	[l/min]	2,4	2,4	2,4	2,4	2,4	2,4	2,4	2,4	3,7	3,7	3,7	3,7	3,7	3,7	3,7
Diameter		4"	4"	4"	4"	4"	4"	4"	4"	5"	5"	5"	5"	5"	5"	5"

Water diagram

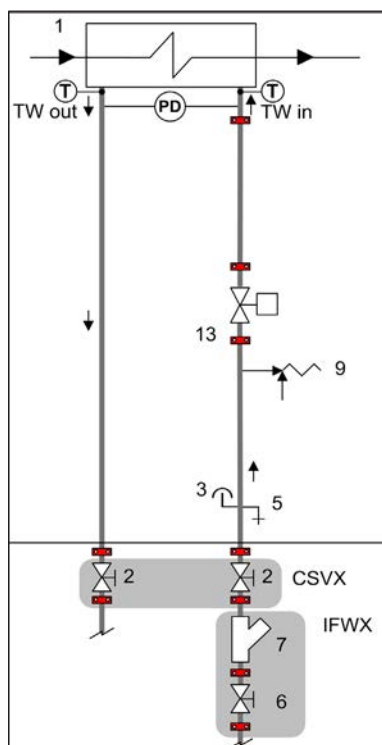

- 1 - Internal exchanger
- 2 - Cutoff valve
- 3 - Purge valve
- 5 - Draw off cock
- 6 - Cutoff valve with quick joints
- 7 - Steel mesh strainer water side
- 9 - Safety valve (6 Bar)
- 13 - 2-way modulating valve

T - Temperature probe
PD - Differential pressure switch

TW in chilled water inlet
TW out chilled water outlet

IFWX = Steel mesh strainer on the water side
CSVX = Couple of manually operated shut-off valves

The grey area indicates further optional components.

Hydronic assemblies - Cooling side

V2MCP - Cooling side 2-way modulating valve for high DP

Configuration with 1 ball modulating 2-way valve, equal-percentage source side and components according to the key indicated on the water diagram. All water fittings are Victaulic type.

The valve is suitable for pressure difference up to 4 bar and guarantees a seeping equal to 0.

The 2-way source side modulating valve, installed on the source side exchanger inlet, modulates the flow of water in response to a 0-10 V signal from the unit's controller.

Cooling side 2-way modulating valve pressure drops for high DP

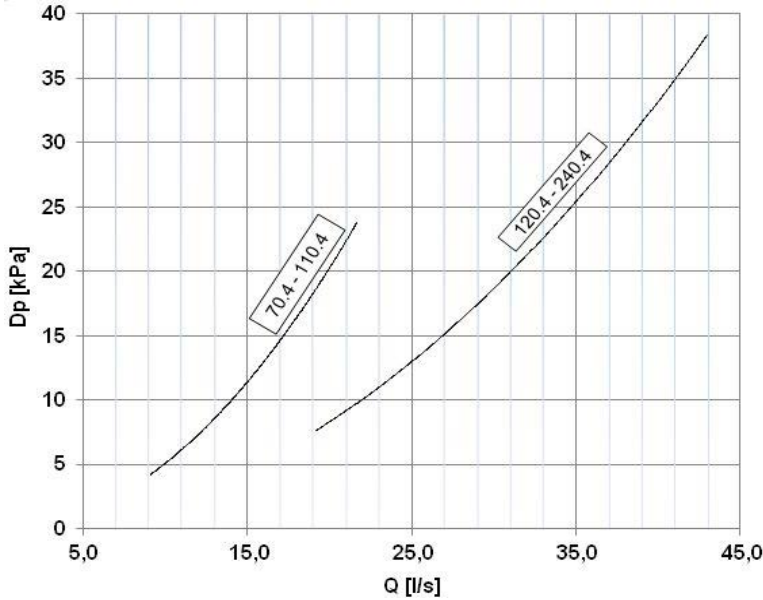

The pressure drops, water side, are calculated considering an average water temperature of 7°C.

Q = Water flow rate [l/s]
DP = Pressure drops [kPa]

Max opening DP	[bar]	4	4	4	4	4	4	4	4	4	4	4	4	4	4
Max. seeping	[l/min]	0	0	0	0	0	0	0	0	0	0	0	0	0	0
Diameter		4"	4"	4"	4"	4"	4"	4"	5"	5"	5"	5"	5"	5"	5"

Water diagram

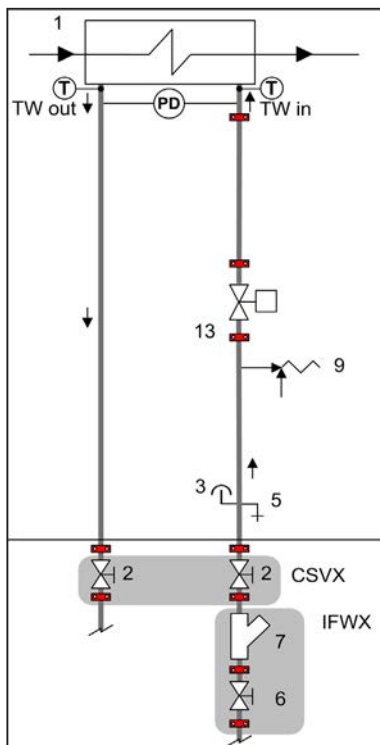

- 1 - Internal exchanger
- 2 - Cutoff valve
- 3 - Purge valve
- 5 - Draw off cock
- 6 - Cutoff valve with quick joints
- 7 - Steel mesh strainer water side
- 9 - Safety valve (6 Bar)
- 13 - 2-way modulating valve for high DP

T - Temperature probe
PD - Differential pressure switch

TW in chilled water inlet
TW out chilled water outlet

IFWX = Steel mesh strainer on the water side
CSVX = Couple of manually operated shut-off valves

The grey area indicates further optional components.

Accessories

MHP - High and low pressure gauges

It includes two liquid pressure gauges for the analog measurement of refrigerant pressures on suction and discharge lines of the compressors with pressure sockets installed in the unit in an easily accessible location.



SDV - Cutoff valve on compressor supply and return

An option which integrates the supply cutoff valve, which is supplied as standard. The presence of the cock at the intake as well enables the compressors to be isolated and substituted without discharging the refrigerant from within the refrigeration circuit. This means that the extraordinary maintenance activities are facilitated.

The device is installed built-in the unit.

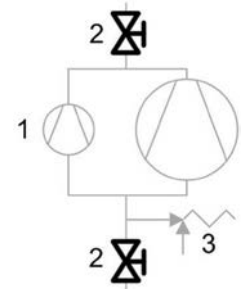

1. Compressors
2. SDV option
3. Safety valve

PFCP - Power factor correction capacitors (cosfi > 0.9)

The component is necessary to lower the phase difference between current and voltage in the electromagnetic components of the unit (e.g. asynchronous motors). The component allows to put the cosfi power factor to values on average higher than 0.9, reducing the network reactive power. This often leads to an economic benefit which the energy provider grants to the final user.

The device is installed and wired built-in the unit.



MF2 - Multi-function phase monitor

The multifunction phase monitor controls all phases and their sequence, checks for voltage anomalies (+/-10%), and automatically restores operation of the unit as soon as the power supply returns to normal.

This control allows to:

- salvaguardare i componenti interni dell'unità, che essendo alimentati da una tensione anomala potrebbero funzionare in modo non corretto o rompersi;
- quickly identify, among the alarms of the unit's components, the real cause of the malfunction due to the sudden change in voltage.

ECS - ECOSHARE function for the automatic management of a group of units

Device allows automatic management of units that operate on the same hydraulic circuit, by creating a local communication network. There are three control modes that can be set via a parameter during the units start-up. Two control modes distribute the heat load on the available units by following the distribution logic to benefit of efficiency levels at part load and one shift the supply water set-point temperature on the group of units.

Moreover:

Mode 1 - distribute the heat load and keeps all the pumps active;

Mode 2 - distribute the heat load and activates only the pumps of the unit required to operate.

The device allows for rotation based on the criterion of minimum wear and management of units in stand-by. In case of failure of one unit the load is distributed in the other units.

The units can be of various sizes but of the same type: all reversible heat pumps, or all air-cooled liquid chiller. The set of units is controlled by a Master unit. The local network can be extended up to 7 units (1 Master and 6 Slave).



The unit supplied with this device can also be equipped at the same time with the RCMRX option and one of the CMSC11 / CMSC9 / CMSC10 options.

SFSTR – Disposal for inrush current reduction

Electronic device which automatically starts up the compressors gradually, reducing the starting current for the unit by around 40% in comparison with the nominal value. This results in the reduction of the starting torque of the ON/OFF compressor, it is more protected from mechanical stresses leading to an increased life of the component. The noise is also reduced.

Device installed and wired built-in the unit.



In sizes 180.4, 200.4, 220.4 and 240.4 the larger size compressor is standard equipped with device for progressive start-up, defined part-winding. For these units the soft-starter benefits are guaranteed on lower size compressors, maintaining unchanged the M.I.C. (max. inrush current) of the standard unit.



The compressors with 60 HP of nominal capacity need the standard device for the progressive start-up defined part-winding.

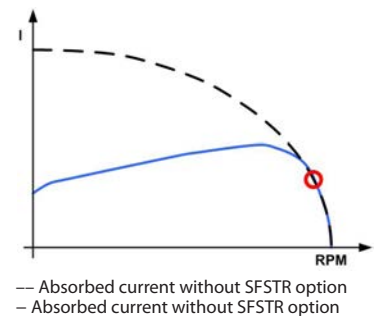

CMSC8 - Serial communication module for BACnet supervisor

Module allows the serial connection of the supervision system, using BACnet as the communication protocol. It enables access to the complete list of operational variables, commands and alarms. Using this accessory every unit can dialogue with the main supervision systems.

Device installed and wired built-in the unit.



The configuration and management activities for the BACnet networks are the responsibility of the client.



The total length of each serial line do not exceed 1000 meters and the line must be connected in bus typology (in/out)

CMSC9 - Serial communication module for Modbus supervisor

Module allows the serial connection of the supervision system, using Modbus as the communication protocol. It enables access to the complete list of operational variables, commands and alarms. Using this accessory every unit can dialogue with the main supervision systems.

Device installed and wired built-in the unit.



The total length of each serial line do not exceed 1000 meters and the line must be connected in bus typology (in/out)

CMSC10 - Serial communication module for LonWorks supervisor

Module allows the serial connection of the supervision system which uses the LonWorks communication protocol. It enables access to a list of operating variables, commands and alarms which comply with the Echelon® standard.

Device installed and wired built-in the unit.



The configuration and management activities for the LonWorks networks are the responsibility of the client.



LonWorks technology uses the LonTalk® protocol for communicating between the network nodes. Contact the service supplier for further information.



The total length of each serial line do not exceed 1000 meters and the line must be connected in bus typology (in/out)

IVFDT - Inverter driven variable flow-rate user side control depending on the temperature differential

Option allows water flow-rate modulation to the unit during partial load conditions, maintaining stable the temperature difference between inlet and outlet to the heat exchanger. Flow-rate modulation is managed by embedded logic thanks to built-in flow-rate control device and temperature probes.

Designed for systems with primary circuit variable flow-rate systems decoupled from secondary circuit. With no building load the unit switches off the compressors while concerning pumps is possible to select:

- Active pumps with minimum flow-rate, monitoring secondary circuit temperature variations
- Pump switching off, periodically activating them (settable time) leading secondary circuit temperatures on primary circuit
- Pump switching off and waiting for the user signal for activation (free potential).

Device installed and wired built-in the unit, available only with VARYFLOW+ option.



The airflow control is active only with thermoregulation on the return temperature.

CONTA2 - Energy meter

Allows to display and record the unit's main electrical parameters. The data can be displayed on the device display or via the supervisor through the specific protocol variables.

It is possible to control:

- voltage (V),
- absorbed current (A),
- frequency (Hz),
- cosφi,
- power input (KW),
- absorbed energy (KWh),
- harmonic components (%).

The device is installed and wired built-in the unit.



On the device is present a serial port with Modbus protocol for the connection to the supervision system.

SCP4 - Set-point compensation with 0-10 V signal

Device allows the changing of the preset set point by means to an external 0÷10 V signal. The interruption of the signal the set-point is at the nominal set value. The limit values can be changed within wide values.

Device installed and wired built-in the unit.



SPC2 - Set-point compensation with outdoor temperature probe

Device allows the automatic regulation of the preset set-point depending of the outside temperature air measured by the unit probe. This device allows to get the sliding supply water temperature, which varies depending on external conditions, enabling energy savings throughout the entire system.

Device installed and wired built-in the unit.

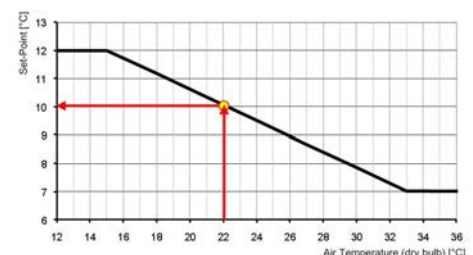

RPRPDI - Refrigerant leak detector with pump down function in the casing

Leak detector device built-in installed and placed inside the compressor box, It detects leaks of the internal refrigeration circuit and automatically enables the “pump-down” function, storing the refrigerant inside the finned coil exchanger. During pump-down, cooling capacity is not produced by the unit. At the end of the operation the unit is switched off and a dedicated alarm signal is available directly inside the electrical panel.

ACIE - Antifreeze heater for internal exchanger protection

The option makes it possible to avoid the formation of ice in the plate exchanger and to preserve its correct operation.

This is an electric heating element fastened to the outside of the exchanger. It activates if the water temperature drops below a set limit.

The device is recommended during the winter when the unit is in stand-by or if the system is not in use for long periods of time.

The device is installed and wired built-in the unit.



When the unit is electrically disconnected, the device is not in operation.



The device only protects the water side exchanger. Anti-freeze protection of the plumbing connections is the responsibility of the client.

EHCS - Source side antifreeze electric heaters

The option makes it possible to avoid the formation of ice in the plate exchanger and to preserve its correct operation.

This is an electric heating element fastened to the outside of the exchanger. It activates if the water temperature drops below a set limit.

The device is recommended during the winter when the unit is in stand-by or if the system is not in use for long periods of time.

The device is installed and wired built-in the unit.



When the unit is electrically disconnected, the device is not in operation.



The device only protects the water side exchanger. Anti-freeze protection of the plumbing connections is the responsibility of the client.

AP - Rear water fittings

The basic acoustic configuration (BN) is without water fittings both on source side and the user side. The water connection is made inside the unit (provided by the Customer).

This option simplifies the water connection placing the fittings flush to the unit both on source side and on user side.

It includes 4 internal pipes up to the unit external panel, 8 Victaulic fittings, 4 pieces “to be brazed” for the connection of the installation.



The rear water fittings are an option automatically selected matched to any hydronic assembly built-in to the unit (user side and source side).

Accessories separately supplied

CSVX - Couple of manually operated shut-off valves

Kit composed of:

- no. 2 cast-iron shut-off butterfly valves, it includes: fast fittings and activation lever with a mechanical calibration lock
- no. 2 of Victaulic type quick connection with insulated casing to isolate the hydraulic circuit at the inlet and outlet.



Installation is the responsibility of the Client, externally to the unit.

PSX - Mains power supply

The device allows the unit and the remote control to communicate with the user interface even when the serial line is longer than 350m.

It must be connected to the serial line at a distance of 350m from the unit and allows to extend the length to 700m maximum in total. The device requires an external power supply at 230V AC.



Power supply at 230V AC provided by Customer

RCMRX - Remote control via microprocessor control

This option allows to have full control over all the unit functions from a remote position.

It can be easily installed on the wall and has the same aspect and functions of the user interface on the unit.

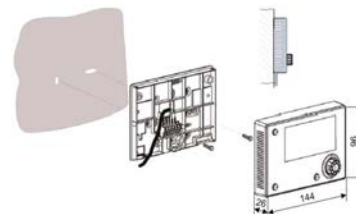

All device functions can be repeated with a normal portable PC connected to the unit with an Ethernet cable and equipped with an internet navigation browser.

The device must be installed on the wall with suitable plugs and connected to the unit (installation and wiring to be conducted by the Customer). Maximum remote control distance 350 m without auxiliary power supply. For distances greater than 350 m and in any case less than 700 m it is necessary to install the 'PSX - Mains power unit' accessory.

Data and power supply serial connection cable n.1 twisted and shielded pair. Diameter of the individual conductor 0.8 mm.

Installation provided by Customer

AVIBX - Antivibration mount support

The rubber antivibration mounts are attached in special housing on the support frame and serve to smooth the vibrations produced by the unit thus reducing the noise transmitted to the support structure.

Installation provided by Customer

IFWX - Steel mesh strainer on the water side

Mechanical steel mesh strainer to place on the water input line to avoid fouling of the exchanger from being clogged by any impurities which are in the hydraulic circuit, easily dismantled for periodical maintenance and cleaning. It also includes: cast-iron shut-off butterfly valve with quick connections and activation lever with a mechanical calibration lock, Victaulic type quick connections with insulated casing.

STEEL MESH FILTER PRESSURE DROP

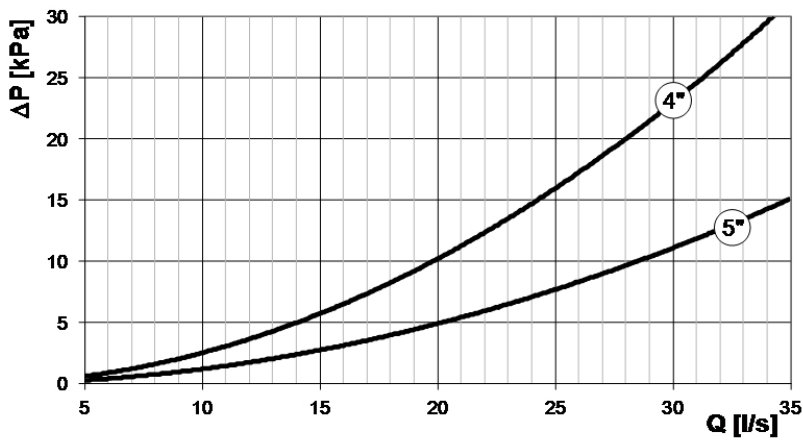

STEEL MESH FILTER FEATURES

Diameter	4"	5"
Degree of filtration	1,6 mm	



Pressure drop referred to a clean filter



Installation is the responsibility of the Client, externally to the unit



Check for the presence of the required hydraulic shut-off valves in the system, in order to undertake periodical maintenance

Separately supplied accessory and available both for user and recovery exchanger.

VS2MHX- Heating side 2-way modulating valve

VS2MCX- Cooling side 2-way modulating valve

Accessory with 1 globe modulating 2-way valve, equal-percentage.

The valve is suitable for pressure difference up to 2 bar for size from 70.4 to 110.4 and up to 1,5 bar for size from 120.4 to 240.4.

The 2-way modulating valve, modulates the flow of water in response to a 0-10 V signal from the unit's controller.

Installation is the responsibility of the Client.



Water fittings are flanged

2-way modulating valve pressure drops

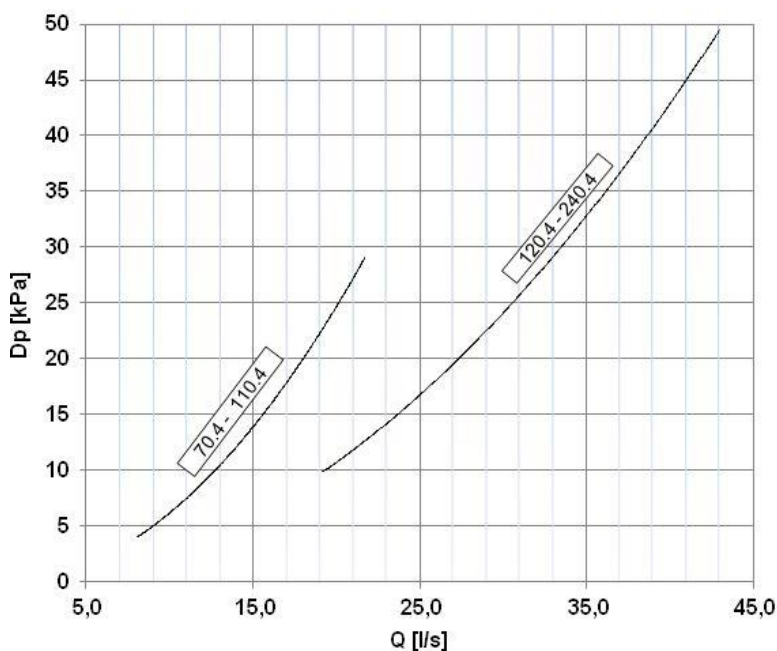

Max opening DP	[bar]	2	1,5
Max. seeping	[l/min]	2,4	3,7
Diameter		4"	5"

Q = Water flow rate [l/s]
DP = Pressure drop [kPa]

VS3MHX - Heating side 3-way modulating valve

VS3MHX - Cooling side 3-way modulating valve

Accessory with 1 globe modulating 3-way valve, equal-percentage.

The valve is suitable for pressure difference up to 2 bar for size from 70.4 to 110.4 and up to 1,5 bar for size from 120.4 to 240.4.

The 3-way modulating valve connects the source side exchanger intake and output, thus bypassing the exchanger and reducing the flow of water inside it, while keeping the machine's delivery flow constant.

The valve modulation is managed by a 0-10V signal generated by the unit electronic control.

Installation is the responsibility of the Client.



Water fittings are flanged

3-way modulating valve pressure drops

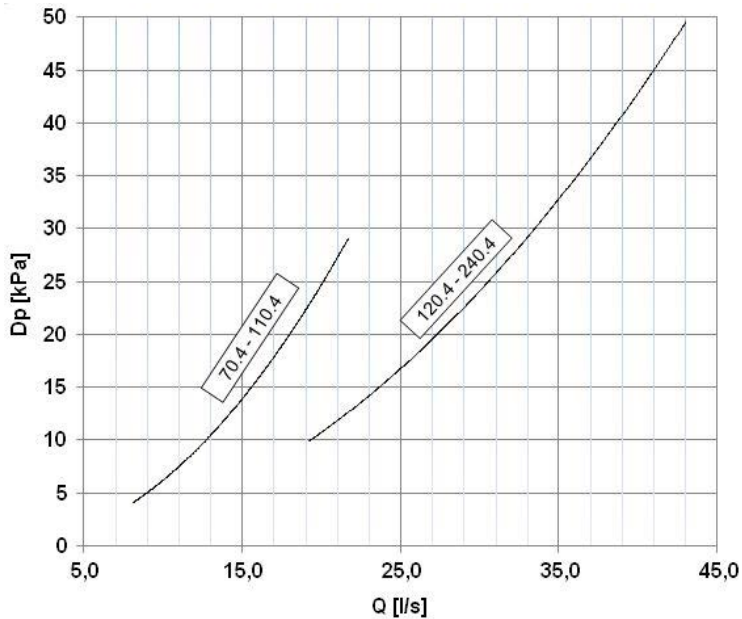

Max opening DP	[bar]	2	1,5
Max. seeping	[l/min]	2,4	3,7
Diametro		4"	5"

Q = Water flow rate [l/s]
DP = Pressure drop [kPa]

V2MHPX - Heating side 2-way modulating valve for high DP

V2MCPX - Cooling side 2-way modulating valve for high DP

Accessory with 1 ball modulating 2-way valve, equal-percentage.

The valve is suitable for pressure difference up to 4 bar and guarantees a seeping equal to 0.

The 2-way modulating valve, modulates the flow of water in response to a 0-10 V signal from the unit's controller.

Installation is the responsibility of the Client.



Water fittings are flanged

2-way modulating valve for high DP pressure drops

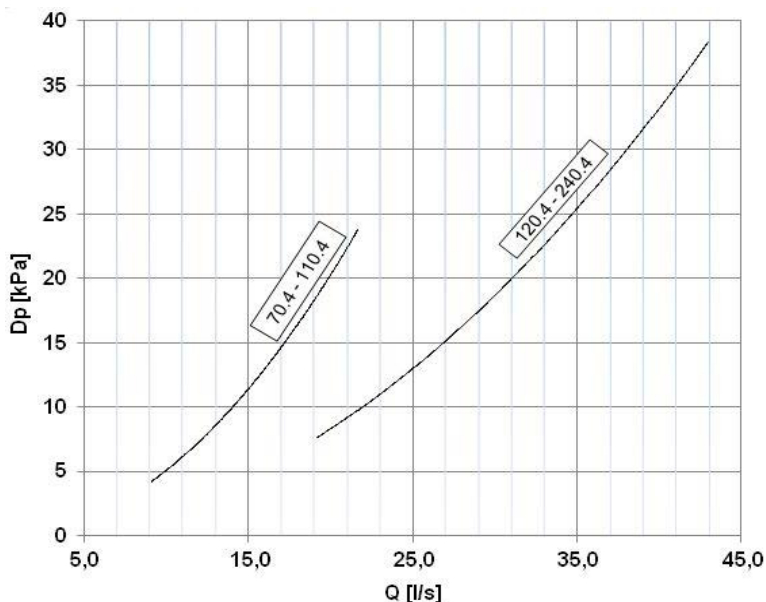

Max opening DP	[bar]	4	4
Max. seeping	[l/min]	0	0
Diameter		4"	5"

Q = Water flow rate [l/s]
DP = Pressure drop [kPa]

Option compatibility - Cooling only version (OCO)

REFERENCE	DESCRIPTION	70.4	75.4	80.4	85.4	90.4	100.4	110.4	120.4	140.4	160.4	180.4	200.4	220.4	240.4
CONFIGURATIONS AND MAIN ACCESSORIES															
(SFSTR)	Soft Start	0	0	0	0	0	0	0	0	0	0	-	-	-	-
EN - SUPER-SILENCED ACOUSTIC CONFIGURATION															
(ACL)	Internal water fittings provided by the Customer	-	-	-	-	-	-	-	-	-	-	-	-	-	-
(AP)	Water connections at the rear	•	•	•	•	•	•	•	•	•	•	•	•	•	•
BN - BASIC ACOUSTIC CONFIGURATION															
(ACL)	Internal water fittings by the Customer	•	•	•	•	•	•	•	•	•	•	•	•	•	•
(AP)	Water fittings at the rear	0	0	0	0	0	0	0	0	0	0	0	0	0	0
ACL - INTERNAL WATER FITTINGS PROVIDED BY THE CUSTOMER															
(VS3MC)	Cooling side three-way modulating valve	-	-	-	-	-	-	-	-	-	-	-	-	-	-
(VS2MCX)	Cooling side two-way modulating valve (separately supplied)	0	0	0	0	0	0	0	0	0	0	0	0	0	0
(VS3MCX)	Cooling side three-way modulating valve (separately supplied)	0	0	0	0	0	0	0	0	0	0	0	0	0	0
(VARYC)	Varyflow + (cooling side 2 inverter pumps)	-	-	-	-	-	-	-	-	-	-	-	-	-	-
(2PMC)	Hydropack cooling side with 2 pumps	-	-	-	-	-	-	-	-	-	-	-	-	-	-
(V2MCP)	Cooling side 2-way modulating valve for high DP	-	-	-	-	-	-	-	-	-	-	-	-	-	-
(V2MCPX)	Cooling side 2-way modulating valve for high DP (separately supplied)	0	0	0	0	0	0	0	0	0	0	0	0	0	0
(HYGH1)	Heating side hydronic unit with one on-off pump	-	-	-	-	-	-	-	-	-	-	-	-	-	-
(HYGH2)	Heating side hydronic unit with two on-off pumps	-	-	-	-	-	-	-	-	-	-	-	-	-	-
(VARYH)	Varyflow + (heating side 2 inverter pumps)	0	0	0	0	0	0	0	0	0	0	0	0	0	0
(VS2MH)	Heating side two-way modulating valve	-	-	-	-	-	-	-	-	-	-	-	-	-	-
(VS3MH)	Heating side three-way modulating valve	-	-	-	-	-	-	-	-	-	-	-	-	-	-
(VS2MHX)	Heating side two-way modulating valve (separately supplied)	0	0	0	0	0	0	0	0	0	0	0	0	0	0
(VS3MHX)	Heating side three-way modulating valve (separately supplied)	0	0	0	0	0	0	0	0	0	0	0	0	0	0
(2PMH)	Hydropack heating side with 2 pumps	-	-	-	-	-	-	-	-	-	-	-	-	-	-
(V2MHP)	Heating side 2-way modulating valve for high DP	-	-	-	-	-	-	-	-	-	-	-	-	-	-
(V2MHPX)	Heating side 2-way modulating valve for high DP (separately supplied)	0	0	0	0	0	0	0	0	0	0	0	0	0	0
IVFDT - INVERTER DRIVEN VARIABLE FLOW-RATE USER SIDE CONTROL DEPENDING ON THE TEMPERATURE DIFFERENTIAL															
(HYGC1)	Cooling side hydronic unit with one on-off pump	-	-	-	-	-	-	-	-	-	-	-	-	-	-
(HYGC2)	Cooling side hydronic unit with two on-off pumps	-	-	-	-	-	-	-	-	-	-	-	-	-	-
(VARYC)	Varyflow + (cooling side 2 inverter pumps)	0	0	0	0	0	0	0	0	0	0	0	0	0	0
(2PMC)	Hydropack cooling side with 2 pumps	-	-	-	-	-	-	-	-	-	-	-	-	-	-
OCO - COOLING ONLY															
(HYGC1)	Cooling side hydronic unit with one on-off pump	0	0	0	0	0	0	0	0	0	0	0	0	0	0
(HYGC2)	Cooling side hydronic unit with two on-off pumps	0	0	0	0	0	0	0	0	0	0	0	0	0	0
(VS2MC)	Cooling side two-way modulating valve	-	-	-	-	-	-	-	-	-	-	-	-	-	-
(VS3MC)	Cooling side three-way modulating valve	-	-	-	-	-	-	-	-	-	-	-	-	-	-
(VS2MCX)	Cooling side two-way modulating valve (separately supplied)	-	-	-	-	-	-	-	-	-	-	-	-	-	-
(VS3MCX)	Cooling side three way modulating valve (separately supplied)	-	-	-	-	-	-	-	-	-	-	-	-	-	-
(VARYC)	Varyflow + (cooling side 2 inverter pumps)	0	0	0	0	0	0	0	0	0	0	0	0	0	0
(2PMC)	Hydropack cooling side with 2 pumps	0	0	0	0	0	0	0	0	0	0	0	0	0	0
(V2MCP)	Cooling side 2-way modulating valve for high DP	-	-	-	-	-	-	-	-	-	-	-	-	-	-
(V2MCPX)	Cooling side 2-way modulating valve for high DP (separately supplied)	-	-	-	-	-	-	-	-	-	-	-	-	-	-
(E-LWF)	External exchanger low flow-rate	0	0	0	0	0	0	0	0	0	0	0	0	0	0
(E-SWF)	External exchanger standard flow-rate	•	•	•	•	•	•	•	•	•	•	•	•	•	•

• Standard

0 Option

- Not available

Option compatibility - Heating only version (OHO)

REFERENCE	DESCRIPTION	70.4	75.4	80.4	85.4	90.4	100.4	110.4	120.4	140.4	160.4	180.4	200.4	220.4	240.4
CONFIGURATIONS AND MAIN ACCESSORIES															
(SFSTR)	Soft Start	0	0	0	0	0	0	0	0	0	0	-	-	-	-
EN - SUPER-SILENCED ACOUSTIC CONFIGURATION															
(ACL)	Internal water fittings provided by the Customer	-	-	-	-	-	-	-	-	-	-	-	-	-	-
(AP)	Water connections at the rear	•	•	•	•	•	•	•	•	•	•	•	•	•	•
BN - BASIC ACOUSTIC CONFIGURATION															
(ACL)	Internal water fittings by the Customer	•	•	•	•	•	•	•	•	•	•	•	•	•	•
(AP)	Water fittings at the rear	0	0	0	0	0	0	0	0	0	0	0	0	0	0
ACL - INTERNAL WATER FITTINGS PROVIDED BY THE CUSTOMER															
(VS3MC)	Cooling side three-way modulating valve	-	-	-	-	-	-	-	-	-	-	-	-	-	-
(VS2MCX)	Cooling side two-way modulating valve (separately supplied)	0	0	0	0	0	0	0	0	0	0	0	0	0	0
(VS3MCX)	Cooling side three-way modulating valve (separately supplied)	0	0	0	0	0	0	0	0	0	0	0	0	0	0
(VARYC)	Varyflow + (cooling side 2 inverter pumps)	-	-	-	-	-	-	-	-	-	-	-	-	-	-
(2PMC)	Hydropack cooling side with 2 pumps	-	-	-	-	-	-	-	-	-	-	-	-	-	-
(V2MCP)	Cooling side 2-way modulating valve for high DP	-	-	-	-	-	-	-	-	-	-	-	-	-	-
(V2MCPX)	Cooling side 2-way modulating valve for high DP (separately supplied)	0	0	0	0	0	0	0	0	0	0	0	0	0	0
(HYGH1)	Heating side hydronic unit with one on-off pump	-	-	-	-	-	-	-	-	-	-	-	-	-	-
(HYGH2)	Heating side hydronic unit with two on-off pumps	-	-	-	-	-	-	-	-	-	-	-	-	-	-
(VARYH)	Varyflow + (heating side 2 inverter pumps)	0	0	0	0	0	0	0	0	0	0	0	0	0	0
(VS2MH)	Heating side two-way modulating valve	-	-	-	-	-	-	-	-	-	-	-	-	-	-
(VS3MH)	Heating side three-way modulating valve	-	-	-	-	-	-	-	-	-	-	-	-	-	-
(VS2MHX)	Heating side two-way modulating valve (separately supplied)	0	0	0	0	0	0	0	0	0	0	0	0	0	0
(VS3MHX)	Heating side three-way modulating valve (separately supplied)	0	0	0	0	0	0	0	0	0	0	0	0	0	0
(2PMH)	Hydropack heating side with 2 pumps	-	-	-	-	-	-	-	-	-	-	-	-	-	-
(V2MHP)	Heating side 2-way modulating valve for high DP	-	-	-	-	-	-	-	-	-	-	-	-	-	-
(V2MHPX)	Heating side 2-way modulating valve for high DP (separately supplied)	0	0	0	0	0	0	0	0	0	0	0	0	0	0
IVFDT - INVERTER DRIVEN VARIABLE FLOW-RATE USER SIDE CONTROL DEPENDING ON THE TEMPERATURE DIFFERENTIAL															
(HYGH1)	Heating side hydronic unit with one on-off pump	-	-	-	-	-	-	-	-	-	-	-	-	-	-
(HYGH2)	Heating side hydronic unit with two on-off pumps	-	-	-	-	-	-	-	-	-	-	-	-	-	-
(VARYH)	Varyflow + (heating side 2 inverter pumps)	0	0	0	0	0	0	0	0	0	0	0	0	0	0
(2PMH)	Hydropack heating side with 2 pumps	-	-	-	-	-	-	-	-	-	-	-	-	-	-
OHO - HEATING ONLY															
(HYGH1)	Heating side hydronic unit with one on-off pump	0	0	0	0	0	0	0	0	0	0	0	0	0	0
(HYGH2)	Heating side hydronic unit with two on-off pumps	0	0	0	0	0	0	0	0	0	0	0	0	0	0
(VARYH)	Varyflow + (heating side 2 inverter pumps)	0	0	0	0	0	0	0	0	0	0	0	0	0	0
(VS2MH)	Heating side two-way modulating valve	-	-	-	-	-	-	-	-	-	-	-	-	-	-
(VS3MH)	Heating side three-way modulating valve	-	-	-	-	-	-	-	-	-	-	-	-	-	-
(VS2MHX)	Heating side two-way modulating valve (separately supplied)	-	-	-	-	-	-	-	-	-	-	-	-	-	-
(VS3MHX)	Heating side three-way modulating valve (separately supplied)	-	-	-	-	-	-	-	-	-	-	-	-	-	-
(2PMH)	Hydropack heating side with 2 pumps	0	0	0	0	0	0	0	0	0	0	0	0	0	0
(V2MHP)	Heating side 2-way modulating valve for high DP	-	-	-	-	-	-	-	-	-	-	-	-	-	-
(V2MHPX)	Heating side 2-way modulating valve for high DP (separately supplied)	-	-	-	-	-	-	-	-	-	-	-	-	-	-
(E-LWF)	External exchanger low flow-rate	-	-	-	-	-	-	-	-	-	-	-	-	-	-
(E-SWF)	External exchanger standard flow-rate	•	•	•	•	•	•	•	•	•	•	•	•	•	•

• Standard

0 Option

- Not available

Dimensional drawings

Acoustic configuration: Super-silenced (EN)

Size 70.4-110.4

DAA8Q70.4_110.4_EN REV00
Data/Date 03/08/2016

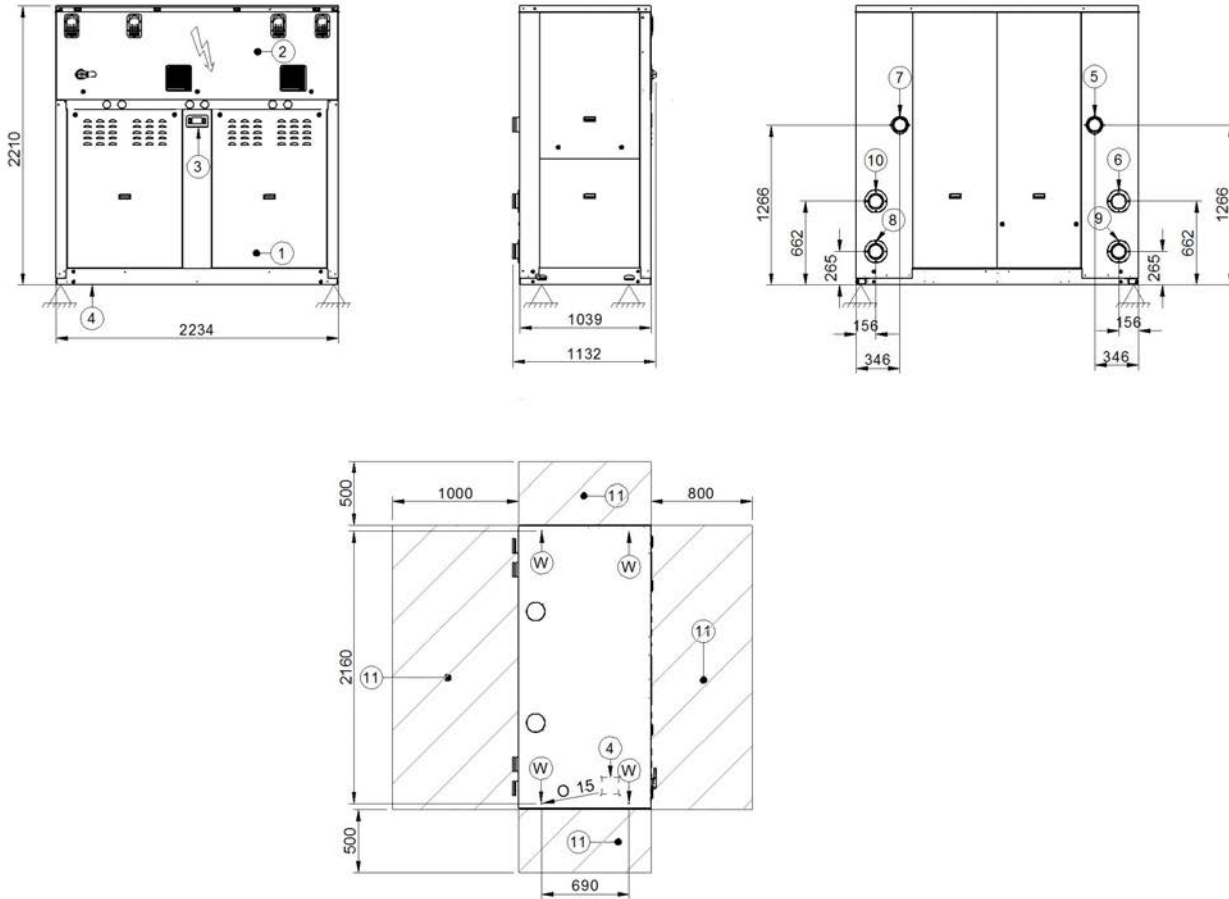

- | | |
|--|--|
| <ul style="list-style-type: none"> 1. Compressor enclosure 2. Electrical panel 3. Control keypad 4. Power input 5. Hot side return from the system water with pumps (4"Viciaulic) 6. Hot side supply to the system water (4"Viciaulic) | <ul style="list-style-type: none"> 7. Cold side return from the system water with pumps (4"Viciaulic) 8. Cold side supply to the system water (4"Viciaulic) 9. Hot side return from the system water without pumps (4"Viciaulic) 10. Cold side return from the system water without pumps (4"Viciaulic) 11. Functional spaces |
|--|--|

Size		70.4	75.4	80.4	85.4	90.4	100.4	110.4
A - Length	mm	2234	2234	2234	2234	2234	2234	2234
B - Depth	mm	1132	1132	1132	1132	1132	1132	1132
C - Height	mm	2210	2210	2210	2210	2210	2210	2210
Shipping weight	kg	1187	1209	1269	1289	1342	1593	1645
Operating weight	kg	1246	1268	1336	1356	1419	1692	1751

The presence of optional accessories may result in a substantial variation of the weights shown in the table.

Dimensional drawings

Acoustic configuration: Super-silenced (EN)

Size 120.4-240.4

DAA8Q120.4_240.4_EN REV00
Data/Date 03/10/2016

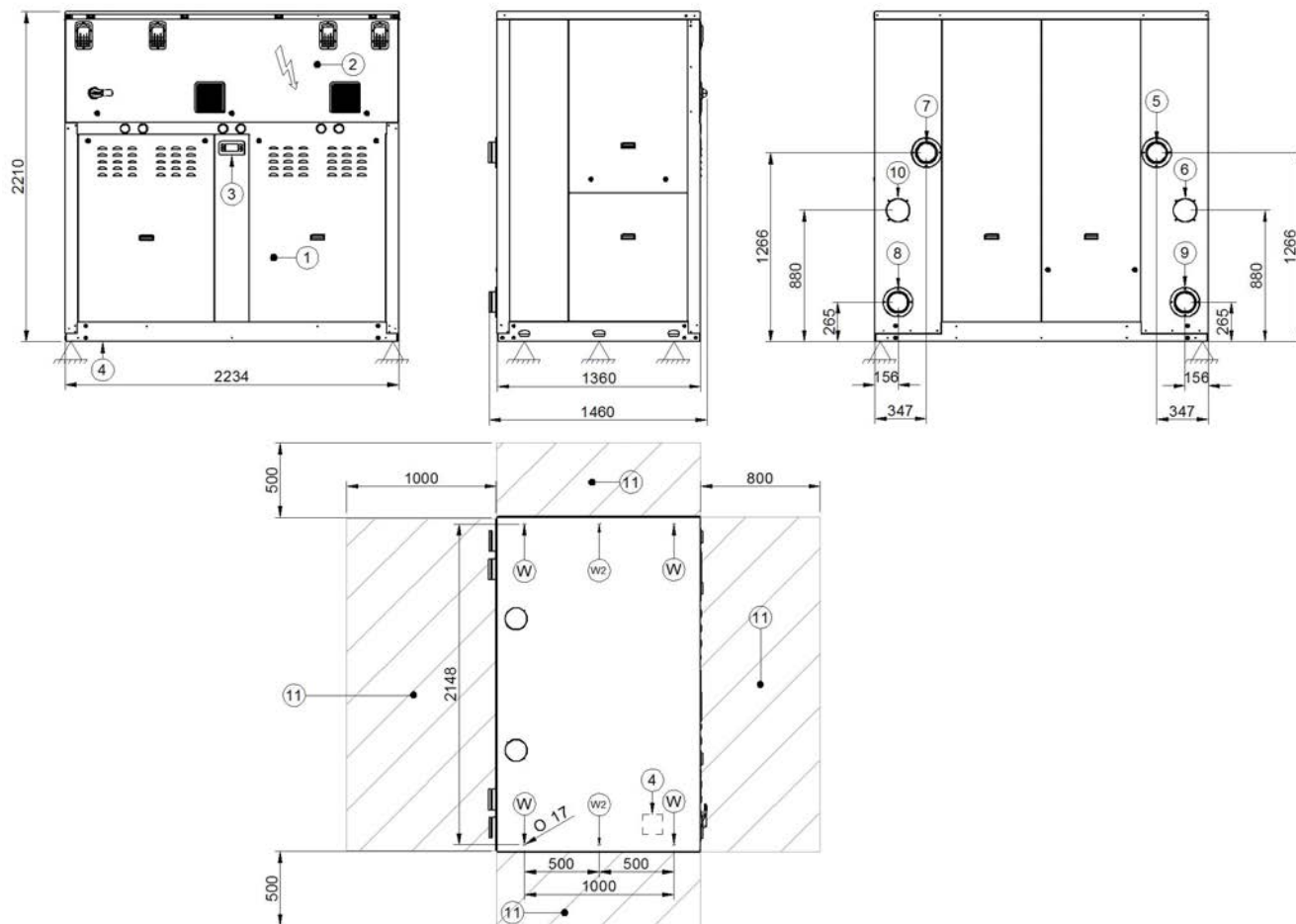

- | | |
|--|---|
| 1. Compressor enclosure | 7. Cold side return from the system (5"Vicaltic) |
| 2. Electrical panel | 8. Cold side supply to the system (5"Vicaltic) |
| 3. Control keypad | 9. Hot side supply from the system water without pumps (5"Vicaltic) |
| 4. Power input | 10. Cold side return from the system without pumps (5"Vicaltic) |
| 5. Hot side supply from the system water(5"Vicaltic) | 11. Functional spaces |
| 6. Hot side supply to the system(5"Vicaltic) | |

Size		120.4	140.4	160.4	180.4	200.4	220.4	240.4
A - Length	mm	2234	2234	2234	2234	2234	2234	2234
B - Depth	mm	1460	1460	1460	1460	1460	1460	1460
C - Height	mm	2210	2210	2210	2210	2210	2210	2210
Shipping weight	kg	1818	1934	2080	2263	2190	2332	2449
Operating weight	kg	1935	2052	2213	2412	2496	2650	2779

The presence of optional accessories may result in a substantial variation of the weights shown in the table.

Dimensional drawings

Acoustic configuration: basic (BN)

Size 70.4-110.4

DAA8Q70.4_110.4_BN REV00
Data/Date 03/08/2016

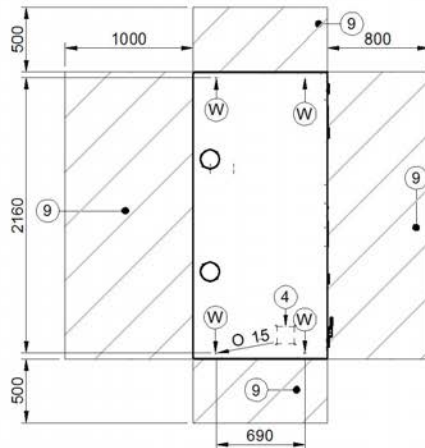
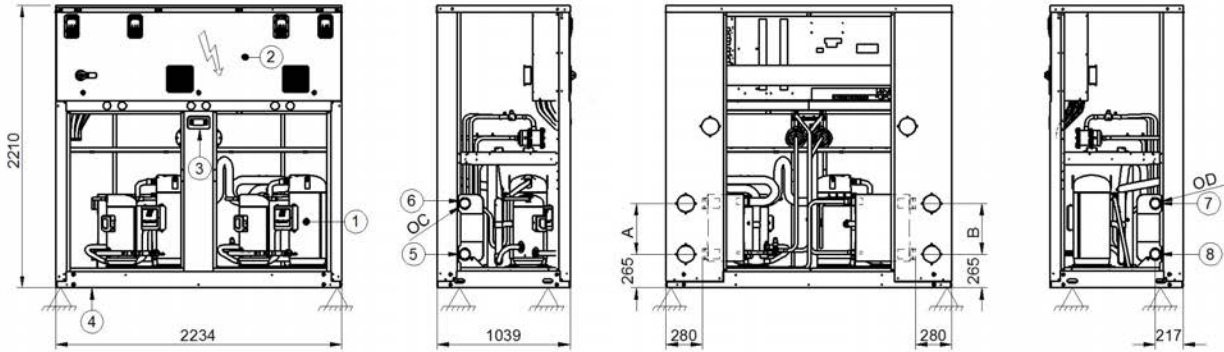

- 1. Compressor enclosure
- 2. Electrical panel
- 3. Control keypad
- 4. Power input
- 5. Hot side return from the system water
- 6. Hot side supply to the system water

- 7. Cold side return from the system water
- 8. Cold side supply to the system water
- 9. Functional spaces

With on-board pumps or tube kits, refer to the dimensional drawings of the "EN" version.

Size		70.4	75.4	80.4	85.4	90.4	100.4	110.4
A - Length	mm	2234	2234	2234	2234	2234	2234	2234
B - Depth	mm	1040	1040	1040	1040	1040	1040	1040
C - Height	mm	2210	2210	2210	2210	2210	2210	2210
Shipping weight	Kg	1057	1079	1139	1159	1212	1463	1515
Operating weight	Kg	1115	1137	1206	1226	1288	1562	1621

The presence of optional accessories may result in a substantial variation of the weights shown in the table .

Dimensional drawings

Acoustic configuration: basic (BN)

Size 120.4-240.4

DAA8Q120.4_240.4_BN REV00
Data/Date 03/10/2016

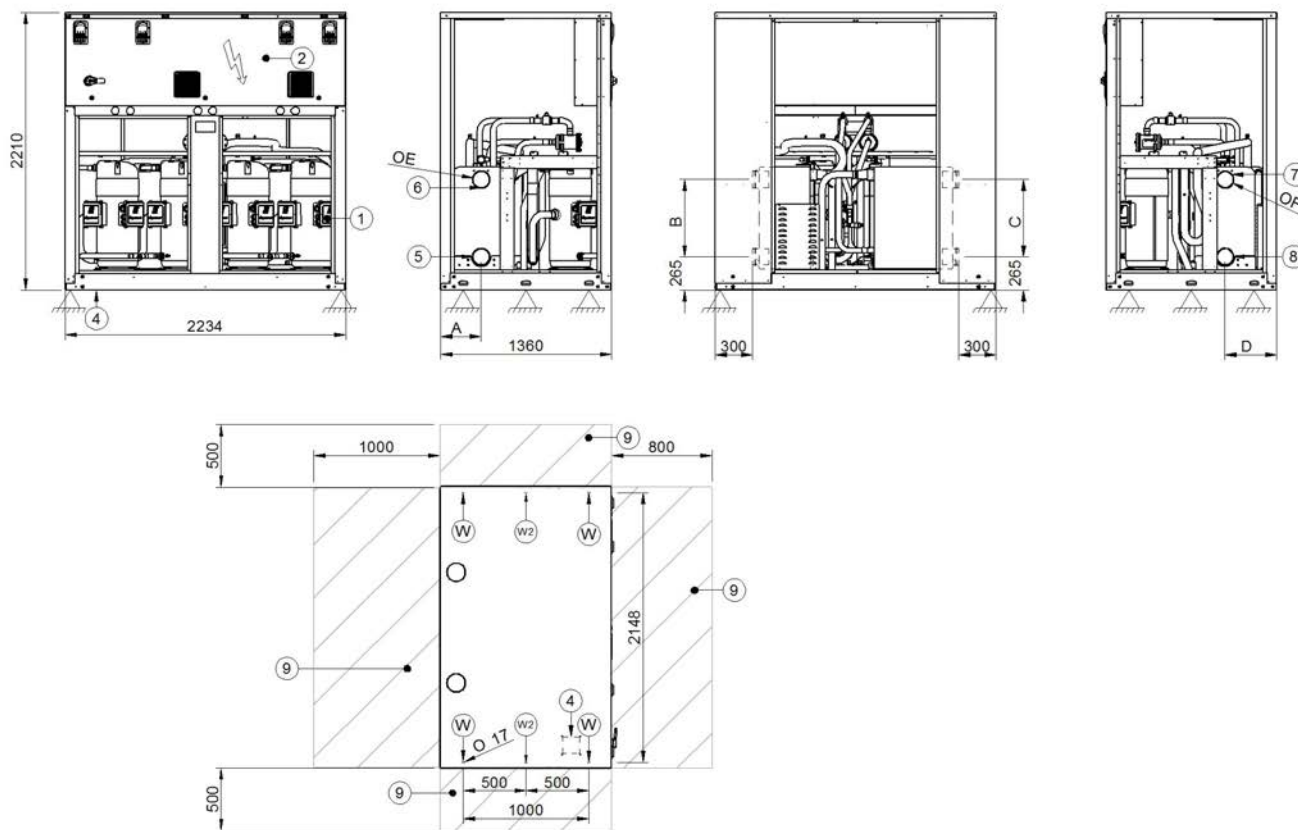

1. Compressor enclosure
2. Electrical panel
3. Control keypad
4. Power input
5. Hot side supply from the system water
6. Hot side supply to the system

7. Cold side return from the system
8. Cold side supply to the system
9. Functional spaces

With on-board pumps or tube kits, refer to the dimensional drawings of the "EN" version.

Size		120.4	140.4	160.4	180.4	200.4	220.4	240.4
A - Length	mm	2234	2234	2234	2234	2234	2234	2234
B - Depth	mm	1360	1360	1360	1360	1360	1360	1360
C - Height	mm	2210	2210	2210	2210	2210	2210	2210
Shipping weight	Kg	1660	1776	1922	2105	2190	2332	2449
Operating weight	Kg	1777	1893	2054	2253	2337	2491	2621

The presence of optional accessories may result in a substantial variation of the weights shown in the table.

Page intentionally left blank

Page intentionally left blank

**CLIVET SPA**

Via Camp Lonc 25, Z.I. Villapaiera - 32032 Feltre (BL) - Italy
Tel. + 39 0439 3131 - Fax + 39 0439 313300 - info@clivet.it

CLIVET GROUP UK Limited

4 Kingdom Close, Segensworth East - Fareham, Hampshire - PO15 5TJ - United Kingdom
Tel. + 44 (0) 1489 572238 - Fax + 44 (0) 1489 573033 - enquiries@clivetgroup.co.uk

CLIVET GROUP UK Limited (Operations)

Units F5&F6 Railway Triangle Ind Est, Walton Road - Portsmouth, Hampshire - PO6 1TG - United Kingdom
Tel. +44 (0) 2392 381235 - Fax. +44 (0) 2392 381243 - service@clivetgroup.co.uk

CLIVET ESPAÑA S.A.U.

C/ Bac de Roda, 36 - 08019 Barcelona - España
Tel: +34 93 8606248 - Fax +34 93 8855392 - info@clivet.es

Av.Manoterás Nº 38, Oficina C303 - 28050 Madrid - España
Tel. +34 91 6658280 - Fax +34 91 6657806 - info@clivet.es

CLIVET GmbH

Hummelsbütteler Steindamm 84, 22851 Norderstedt - Germany
Tel. + 49 (0) 40 32 59 57-0 - Fax + 49 (0) 40 32 59 57-194 - info.de@clivet.com

CLIVET RUSSIA

Elektrozavodskaya st. 24, office 509 - 107023, Moscow, Russia
Tel. + 74956462009 - Fax + 74956462009 - info.ru@clivet.com

CLIVET MIDEAST FZCO

Dubai Silicon Oasis (DSO), High Bay Complex, Office N. 20, PO BOX 342009, Dubai, UAE
Tel. + 9714 3208499 - Fax + 9714 3208216 - info@clivet.ae

CLIVET AIRCONDITIONING SYSTEMS PRIVATE LIMITED

4BA, Gundecha Onclave, Kherani Road - Sakinaka, Andheri (East) - Mumbai 400 072 - India
Tel. +91 22 6193 7000 - Fax +91 22 6193 7001 - info.in@clivet.com

www.clivet.com
www.clivetlive.com

A Group Company of

