



*A single-unit reversible air/
water heat pump for heating,
cooling and the production of
domestic hot water*

Edge EVO 2.0 - EXC WiSAN-YME 1 S 2.1-14.1 RANGE



TECHNICAL BULLETIN



3	Technical features of a standard unit
5	Hybrid version
6	Built-in options
7	Accessories supplied separately
11	View and functional diagram
13	General technical data
17	Electrical data
19	Operating range
20	Hydraulic data
23	User interface (HMI)
24	Connection of a DHW boiler
25	Main functions
34	Management of auxiliary heat sources
38	Management of units in cascade
40	Connectivity
45	Electrical connections
46	Connection of external elements
47	Performance in heating
51	Data for calculation UNI/TS 11300-4
55	Performance in cooling
57	Data for calculation UNI/TS 11300-3
58	Dimensions, weights and connections
61	Clearances for installation
62	Compatibility of accessories/configurations
64	Accessories and configurations: technical details
98	Simplified diagrams of the system
105	Protections for unit and water circuit
108	Electrical protections
109	Electrical protections



Clivet is taking part in the EUROVENT certification programme up to 1,500 kW.
The products concerned appear in the certified products list of the EUROVENT
www.eurovent-certification.com site.

Technical features of a standard unit

Edge EVO 2.0 - EXC is a monobloc reversible air/water heat pump for heating, cooling and domestic hot water production. The unit was designed and made to be installed outdoors, with the need to only connect the power supply and water pipes.

Seasonal efficiency class in heating mode (according to EU 811/2013):

- A++ or A+ (water supply at 55 °C)
- A++ or A++ (water supply at 35 °C)



Refrigeration circuit

The unit is equipped with a steam compression refrigeration circuit, which comprises:

- brushless DC inverter hermetic rotary compressor with intake and supply gas temperature probes and heater for preheating the oil
- source side finned coil heat exchanger with “Blue fin” treatment
- user side plate heat exchanger with antifreeze heater
- electronic thermostatic expansion valve with self-regulating PWM logic
- 4-way valve for reversing the refrigeration cycle
- suction liquid separator and receiver
- dehydrator filter
- high and low pressure switches

Compressor

Twin Rotary DC hermetic type compressor with soft start and controlled by an inverter that allows the power delivered to be constantly modulated according to actual demand, ensuring the best in terms of reliability, low consumption and high seasonal efficiency. It is equipped with a motor protection device for overheating, overcurrents and excessive temperatures of the supply gas, and comes with oil charge. A guard heater with automatic insertion prevents the refrigerant from diluting the oil when the compressor stops. It is mounted on vibration-absorbing rubber mounts to ensure vibration-free operation under all operating conditions and has a sound-proofed casing which minimises noise emissions.

Refrigerant

Eco-friendly refrigerant gas R-32

Fan

Single fan (for sizes 2.1 to 8.1) or double axial fan (for sizes 9.1 to 14.1) with sickle-shaped blades made of ABS resin, housed in an aerodynamically shaped nozzle to increase efficiency and lower the noise level. Condensation is controlled by means of a directly coupled high-efficiency variable speed brushless DC motor, which regulates its speed continuously.

User side exchanger

AISI 316 stainless steel brazed plate heat exchanger with low refrigerant content and high exchange surface, complete with external anti-condensation thermal insulation 10 mm thick in sintered expanded polypropylene.

There are water temperature probes at the inlet and outlet of the heat exchanger for constant monitoring and protection: they activate the antifreeze function when the room temperature and/or the water supply temperature fall below the limit values. The antifreeze function is also active when the unit is in stand-by mode.

Source side exchanger

Direct expansion finned coil exchanger made with aluminium fins and copper pipes mechanically expanded to better adhere to the fin collar. The spacing between the fins is carefully designed to maximise heat exchange efficiency and reduce defrosting in the interest of seasonal efficiency. The fins are made of aluminium with “Blue fin” hydrophilic treatment which facilitates the elimination of condensate, further improving defrosting.

The unit has been designed in such a way that, when it is in Heating mode, the refrigerant fluid circulates effectively inside the exchanger during evaporation to prevent the formation of ice at the bottom. There are also two probes that detect the outdoor air temperature and the temperature of the heat exchanger, in order to monitor and optimize defrosting.

Structure

Structure designed for outdoor installation, base and supporting structure in sheet steel with 12/10 thick hot-dip galvanized surface treatment, and insulation in thermoformed material. Full polyester powder coating in RAL 9001 for exposed parts, which guarantees complete resistance to corrosion and weathering over time.

Panelling

RAL 9001 painted zinc-magnesium sheet metal panels for outdoor installation that ensures superior resistance to corrosion and eliminates the need for periodic painting. Each panel can be easily removed to allow full access to internal components for the purpose of inspection and maintenance.

Water circuit

The unit can be connected to a water circuit and is equipped with:

- high-efficiency primary circulator
- automatic vent valve
- 3 bar pressure relief valve
- flow switch for water circulation control
- pressure gauge
- 8-litre system-side expansion vessel (with an available volume of 4.8 litres and a pre-charge pressure of 1 bar)

Pump

Modulating primary circulator equipped with brushless DC motor, with IP44 protection rating.

Control for sizes 2.1 to 8.1 is with a self-regulating inverter: it adjusts its speed depending on how much the water supply temperature (T1) follows the required set-point.

Control for sizes 9.1 to 14.1 is with a 3-speed selector: maximum speed is set by default but can be changed in the field as required.

Electrical panel (power supply and control)

Electrical panel inside the unit with door for ease of access and a power section and control section.

The power section consists of:

- inverter board for management of the compressor
- main power terminals

The control section consists of:

- board for management of the refrigeration circuit, connected to all the sensors that detect the temperature of the outdoor air, evaporation, condensation and compressor. Optimised algorithm for efficient management of defrosting
- board for hydronic management of the system, connected to the flow switch that protects against water shortage and to the temperature probes of the return and supply water
- inverter board for management of the compressor
- connection terminals for controlling the functions of the unit
- terminals for connecting the user interface
- inputs for connecting 1 or 2 zone thermostats
- remote ON/OFF input
- inputs for connection of optional probes (auxiliary heat source, DHW storage, secondary circuit)
- defrosting alarm and status outputs
- outputs for management of secondary pumps, recirculation of domestic hot water, and solar thermal power
- output for management of an auxiliary heat source
- output for electrical management of the heater of the domestic hot water storage tank (max. 4kW)
- RS485 communication port with Modbus output (in the user interface)

User interface

The user interface is used to control the operating parameters of the unit and to manage certain components of the system. It has an integrated temperature sensor and can also be used as a zone thermostat. It also has a Wi-Fi module for management via an App.

The main functions on the user interface are:

- basic settings (ON/OFF, change of operating mode, room/water/DHW temperature settings)
- daily and weekly programming (ON/OFF, set-point and mode settings)
- automatic management of the set-point according to outdoor temperature (in Heating and Cooling mode)
- management of a second zone of the system
- priority management of auxiliary heat sources
- management and programming of ECO, SILENT and anti-legionella modes
- control of all functions of the unit
- displaying of alarms

Accessories supplied with the unit

Some accessories are supplied with the unit that require installation on site:

- user interface with removable microprocessor control with single-zone thermostat function
- 10-metre long water temperature probe, with various uses: for regulating domestic hot water storage tanks, an auxiliary heat source, a mixed zone and the solar circuit, or to detect the temperature of a hydraulic separator.
- steel mesh Y filter
- condensate drain connection

Hybrid version

The hybrid version envisages the installation of a boiler to support/supplement the heat pump. The boiler can produce DHW instantly and is managed by the logic of the heat pump with ON/OFF request and optionally with 0-10V signal for modulation of the set-point.

The integrated €/switch function optimises the integration between the two generators, activating the most cost-effective one based on operating conditions and system efficiency.

Hybrid version

Boiler to be combined with hybrid heat pump to form a system that can work together with the boiler, as a back-up for the heat pump. The logic of the heat pump controls all the boilers with an ON/OFF signal to ensure optimal operation of the system. The boilers can be used as standard with natural gas or LPG, depending on the type of supply available in the field.

The kit includes a condensing boiler and a 10-metre long temperature probe (T1) to be connected in the field.

⚠ *The hybrid version excludes the possibility of selecting electric heaters in the system*

Stand-alone systems

GAS BOILER_UC / GAS BOILER_FE 24.4-33.4 - 4-pipe condensing boiler for hybrid heat pumps

The boiler can produce DHW instantly, allowing the heat pump to work in heating or cooling mode at the same time.

For the FE version, the setpoint via 0-10V signal is controlled by the heat pump. Flue gas intake/discharge fittings can be connected to all versions of the boiler and are to be selected according to the required installation.

Note: to work with LPG, the UC versions require a reducer (supplied as standard with the boiler) which is to be fitted on the nozzle in the field



Flue accessories for boilers

KCSAFX

Vertical coaxial fitting \varnothing 60/100mm

Vertical coaxial flanged polypropylene fitting, measuring 60/100mm in diameter, for the discharge of gas and intake of air for combustion via two coaxial ducts



CCOAX

90° coaxial elbow for \varnothing 60/100 mm horizontal outlet that can be adjusted at 360°

Elbow for the discharge of gas and intake of air, that can be combined with \varnothing 60/100 coaxial pipe with terminal.

The internal section is used for the discharge of the combustion gas while the external section is used for the intake of combustion air.



TCOAX

Coaxial pipe L = 1000mm \varnothing 60/100 with terminal

Pipe for flue gas discharge and air intake through an external wall, with discharge terminal

The internal section is used for the discharge of the combustion gas while the external section is used for the intake of combustion air.



KAS80X

\varnothing 80 mm vertical fittings

Two vertical flanged polypropylene fittings, 80 mm diameter, with inspection ports, which allow the combustion gas discharge and air intake to be split directly from the boiler body

⚠ *Only compatible with GAS BOILER UC 24.4-33.4*



KSDFX

\varnothing 80mm flue gas splitter kit

Polypropylene kit to split the air intake and the flue gas discharge into two 80 mm connections with inspection ports to connect to vertical or bent pipes

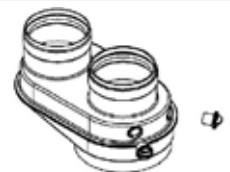

Centralized systems

GAS BOILER_UC 70.2-115.2-200F.2 - 2-pipe condensing boiler for hybrid heat pumps

All the versions use the 0-10V signal of the heat pump to control the set-point, and version 200F.2 also uses Modbus communication.

The 70.2 and 115.2 versions are for wall installation, while the 200F.2 is for installation on a base.



INAILX

INAIL safety kit for installation of single boiler

INAIL-approved 1/2" safety hydraulic kit including pressure gauge, pressure gauge holder, 2 inspection wells, 100 °C lockout thermostat, thermometer, safety pressure switch.

FH100X

ø 100 mm vertical flue gas terminal

Discharge terminal for boilers for outdoor installation, with weather protection



HIDUCX

Remote control for UC 70.2-115.2 boilers

Remote control to manage Heating/ACS parameters and display the operating parameters and alarms.

It also permits communication via Modbus

⚠ Only compatible with GAS BOILER UC 70.2-115.2



Built-in options

IBH

Integrated back-up heater

Electric heater kit integrated in the body of the unit, factory-wired and already equipped with T1 management probe.

The unit's logic manages the ON/OFF function of the heater, which can support, replace or back up the heat pump and can work in Heating mode only, DHW mode only or both modes.

- units 2.1-8.1: 3 kW heater
- units 6.1T to 8.1T: 3/6/9 kW heater with three selections

⚠ Units with this configuration are not stocked and are ordered on demand, with significantly longer lead times than standard units.
⚠ The configuration with backup electric heater excludes the hybrid version with boiler.

Accessories supplied separately

KTFLX

Hose kit for connection to the unit

Kit for connecting the unit to the system, consisting of:

- two 300mm hoses, connections with female swivel flat seat couplings with diameter of 1" (sizes 2.1 to 3.1) or 1 1/4" (sizes 4.1 to 14.1)
- two concealed nipples 1" M - 1" M (sizes 2.1 to 3.1) or 1 1/4" M - 1 1/4" M (sizes 4.1 to 14.1)
- two insulation seals for fixing.



FDMX

Magnetic dirt separator filter for water distribution systems

Magnetic dirt separator filter with minimal pressure drop, to be used to protect the unit (in particular the pump, valves and plate heat exchanger) from damage caused by impurities in the water.

For sizes 2.1 to 8.1, the filter has a transparent bottom for visual inspection without the need for disassembly.

⚠ *It is advisable to use this filter in addition to the normal mesh filter in the system-side circuit.*



ACS200X

200-litre DHW boiler

ACS300X

300-litre DHW boiler

ACS500X

500-litre DHW boiler

ACS1000X

1,000-litre DHW boiler

ACS10SX

1,000 litre DHW boiler with solar coil

Domestic hot water boilers made of carbon steel with internal vitrification treatment according to DIN 4753-3 and UNI 10025. They are equipped with a water/water exchange coil with a surface area compatible with the power ratings of the heat pumps, an inspection flange at the bottom (ACS200/300/500X), a magnesium anode for corrosion protection, and an electric heater.

The boilers have an integrated electric heater and are equipped with removable 70 mm polyurethane (ACS200/300/500X) or 100 mm polyester (ACS1000/10SX) external insulation to minimise heat loss and ensure high efficiency.

For connection to solar thermal circuit:

- the 200, 300 and 500-litre versions can be connected to a solar thermal circuit with a specific optional kit
- the 1,000-litre version has a dedicated tank that, compared to the standard version, has a second integrated coil located in the lower part of the tank

⚠ *Electrical connection to the heat pump requires the optional QERAX kit (for ACS200X, ACS300X or ACS500X) or QERATX (for ACS1000X or ACS10SX)*



SCS08X

Solar coil for ACS200X/ACS300X DHW boilers

SCS12X

Solar coil for ACS ACS500X DHW boilers

Kit for connection of the solar thermal circuit to DHW boilers consisting of a tin-plated finned copper coil and including a perforated flange, flange cover and bolts for fastening

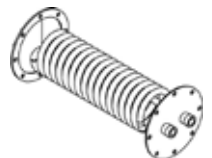

QERAX

Connection kit for single-phase heater on DHW storage tank

QERATX

Connection kit for three-phase heater on DHW storage tank

Kit for managing the electric heater of a DHW storage tank, consisting of:

- Gewiss box to contain and protect the components
- back-up relay to transfer the incoming ON/OFF signal from the unit to the heater of the storage tank (230V voltage signal for QERAX, 400V for QERATX)
- protection fuse



⚠ *The cable of the heater is 1.5m long, so the accessory must be installed close to the storage tank. For installations involving greater distances, replace the cable with one of suitable length*

3DHWX

System/DHW 3-way switching valve

Motorised 3-way switching valve with actuator and 1 1/4" M connections, for diverting the flow of water from the system to the domestic hot water storage tank.

Kits available:

- for sizes 2.1 - 3.1: valve, 1 1/4" F - 1" F reduction and 1" concealed nipple
- for sizes 4.1 to 14.1 (recommended for storage tanks up to 500 litres): valve and M-F connection
- for sizes 4.1 to 14.1 (recommended for storage tanks over 500 litres): valve and M-F fitting



KIRE2HX
KIRE2HLX

Double zone distribution unit: direct + direct

Double zone distribution unit: direct + mixed (with mixing valve)

Kit for managing two-zone distribution systems with 1" F primary side and 1" 1/2 F secondary side connections.

The kit consists of an insulated box for wall installation including manifold/separator, support bracket, anti-rotation jig, 2 distribution units with circulators, water temperature probe and complete water circuits.

The KIRE2HLX version is also equipped with a mixing valve.



KCSX

Secondary circuit kit (1-litre hydraulic circuit breaker + pump)

Kit for single-zone systems with 1" F primary side and 1" M secondary side connections, with insulated separator and internal hydraulic components.

The kit consists of:

- sheet metal case with holes for wall mounting
- 1-litre single-zone hydraulic separator
- variable speed zone circulator
- connecting pipes



DIX
DI50-2X
DI100X

1-litre hydraulic circuit breaker

50-litre hydraulic circuit breaker

100-litre hydraulic circuit breaker

Hydraulic separator used to make the connected water circuits independent, also with inertial storage and deaerator function. The 50-litre and 100-litre versions have 2 pairs of connections on the supply side and 2 pairs of connections on the return one.

The external insulation is made of polyurethane foam (30 mm for DI50-2X and DI100X) to minimize thermal leakage and ensure high efficiency.

Note: DI50-2X and DI100X are supplied with wall mounting kits and 4 caps with gaskets for any unused connections. DI100X is also equipped with feet for floor mounting.

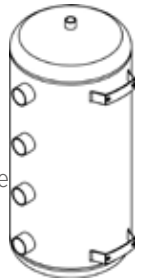

TANKX
KTCAX

System inertial storage tank

Hose kit for connecting the unit to the inertial storage tank

Horizontal inertial storage tank for installation under the base of the unit and connection hose kit.

Sizes 2.1 to 3.1

30-litre tank and hose kit with 1" M connections

Sizes 4.1 to 8.1

70-litre tank and pipe kit with 1"1/4 M connections

Sizes 9.1 to 14.1

100-litre tank and pipe kit with 1"1/4 M connections



T1BX
T1B30X

DHW temperature probe and additional heating source at 10 m

DHW temperature probe and additional heating source at 30 m

NTC water temperature probe with 10 m or 30 m cable.









The probe can be used to detect temperatures:

- Tsolar: solar thermal circuit
- T1: boiler or external electric heater
- T5: DHW tank
- Tw2: mixed zone 2
- Tbt1/Tbt2: hydraulic separator

⚠ The unit is equipped with a T1BX probe as standard.



Accessories supplied separately

<p>PCSX PCS2X</p>	<p>Circulation pump for secondary circuit Oversized circulation pump for secondary circuit Variable speed self-regulating circulator for secondary circuit with standard or increased head.</p>	
<p>PRSX</p>	<p>DHW recirculation pump Circulator with 3-speed selector switch for DHW recirculation</p>	
<p>IBHX IBHTX</p>	<p>Back-up electric heater (single-phase) Back-up electric heater (three-phase) Electric integration/back-up heater kit with power that can be selected in the field from three steps, with power supply 230V/50Hz or 400V+N/50Hz. Kits available: IBHX with 2/4/6 kW output power or IBHTX with 3/6/9 kW output power The kit includes contactors and safety devices for correct operation: manual reset thermostat, automatic reset thermostat and fuses for protection against abnormal overcurrent.</p>	
<p>VAGX</p>	<p>Safety antifreeze valve for system The kit consists of antifreeze valves that allow the fluid to be discharged from the circuit when its temperature reaches a limit value, preventing the formation of ice in the system and consequent damage to the unit and pipes. Kits available: - 2 valves with 1" M connections (for sizes 2.1-3.1) or 1"1/4 M connections (for sizes 4.1 to 8.1) - 1 valve with 1" M connections with a 3/4" - 1" fitting (for sizes 9.1 to 14.1)</p>	
<p>VDACSX</p>	<p>Thermostatic switching valve for domestic water The valve is equipped with 1"1/4 M connections and is designed for hybrid versions with boilers for instant production of DHW in systems that also include DHW boilers. Its function is to divert water from the domestic water storage tank directly to the user when the water temperature is suitable for use. If the temperature is not sufficient for direct use, the switching valve ensures the water passes inside the boiler which, thanks to instant production, guarantees continuous supply.</p>	
<p>DTX</p>	<p>Drain pan with electric heater Drain pan to be fitted to the base of the unit for collecting condensate, with fitting for connection to the drain trap. The drain pan has an automatically activated antifreeze heater that prevents the condensate from freezing, controlled by a dedicated thermostat.</p>	
<p>AMRX AMMSX ASTFX</p>	<p>Kit of antivibration mounts for floor installation Kit of anti-seismic antivibration mounts for floor installation Kit of antivibration mounts for installation on wall brackets, inertial storage tank or tray Vibration dampers to be installed on each of the 6 support points of the unit's base, to reduce the vibrations produced by the compressor during its operation. <ul style="list-style-type: none"> • standard: rubber with integrated fixing bar • for wall-mounted units / units on inertial storage tank with base / units with drain pan: rubber without fixing bar • anti-seismic: spring-loaded with containment of horizontal displacement to prevent the unit from tipping over in the event of multi-directional forces (e.g. wind or earthquake) </p>	
<p>KSIPX</p>	<p>Kit with wall fixing brackets Wall fixing bracket for outdoor unit, adjustable, in galvanised steel painted with polyester powders for outdoor use.</p>	

Accessories supplied separately

HID-TCXBX Black HID-TConnect chronothermostat
HID-TCXNX White HID-TConnect chronothermostat
SWCX IoT SwitchConnect receiver / switch

Chronothermostat for semi-recessed installation with temperature probe. The thermostat is able to manage request for the heat pump and allows control of the system with the App (Clivet Home Connect) or voice assistant (Amazon Alexa or Google Home).

The thermostat can be combined with a radio receiver for managing the request of terminal units or radiant systems, the changing of mode of the heat pump, or the systems with double set-point



ELFOControl³ EVO

Energy assistant for the air-conditioning system that enables efficient management of up to 12 climate zones and, in combination with photovoltaic systems, energy management and monitoring of electricity consumption and self-consumption. Installation of this allows class A control according to EN15232.

See the specific documentation for more details.

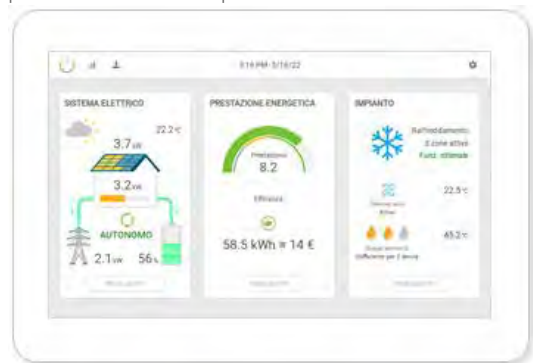

ELFOSun²

Flat-plate solar thermal manifold for empty or pressurised systems for connection to domestic hot water production systems, with optional circulation kit consisting of pump unit, control unit and expansion tank. The panels can be combined in series (up to 5) and are suitable for horizontal or inclined installation with specific kits.

See the specific documentation for more details



View and functional diagram

Sizes 2.1 to 8.1

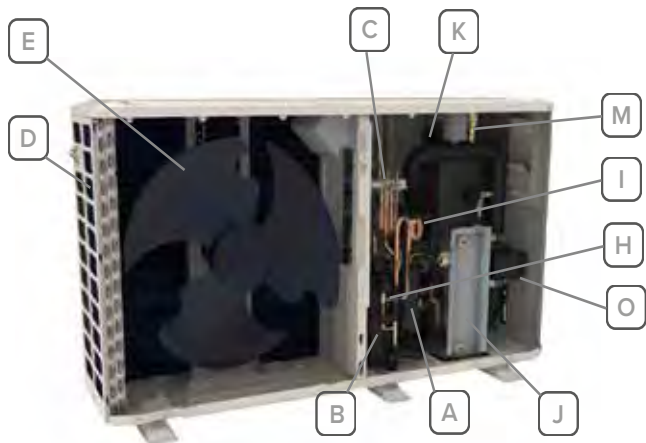

Sizes 9.1 to 14.1

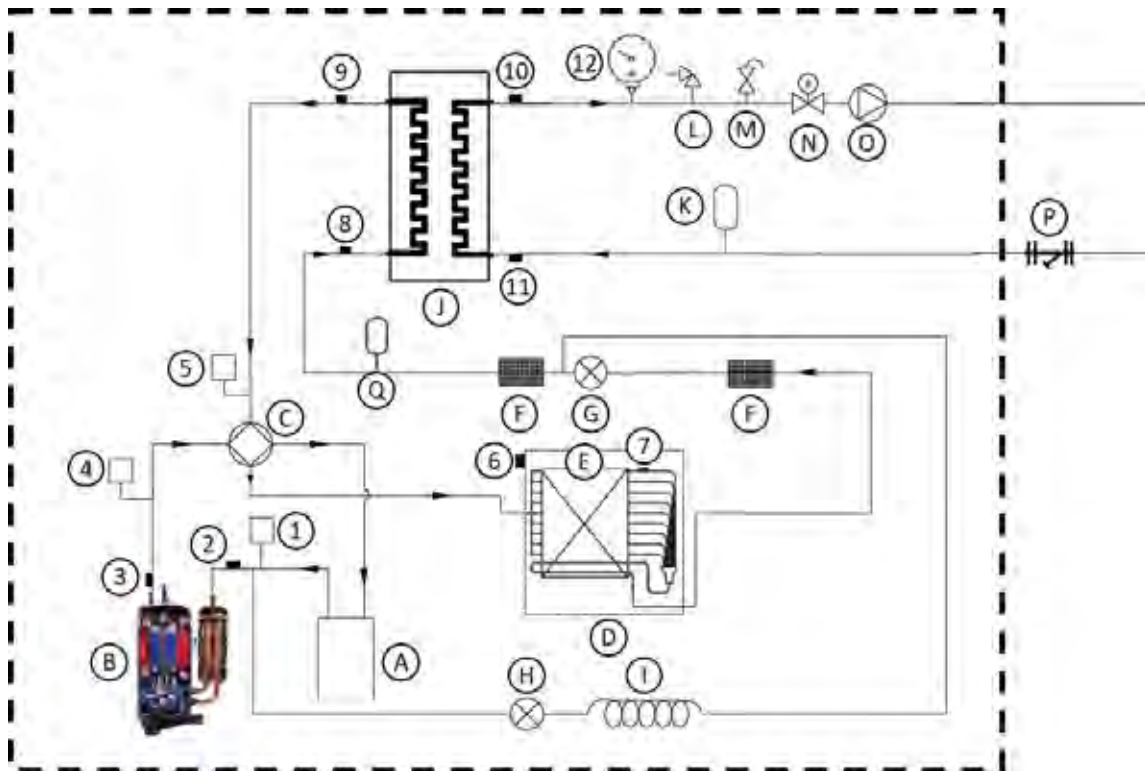
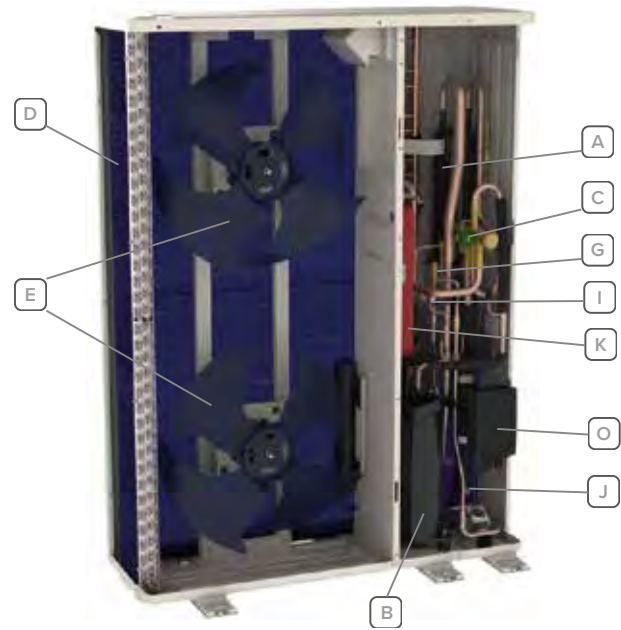

----- Perimeter of the unit

1. LP pressure switch
2. Compressor suction temperature probe
3. Compressor discharge temperature probe
4. HP pressure switch
5. Pressure sensor
6. Outdoor air temperature probe (T4)
7. Source-side heat exchanger temperature probe (T3)
8. Two-phase refrigerant temperature probe (T2)
9. Superheated gas temperature probe (T2b)
10. Flow water temperature probe (T_{wout})
11. Return water temperature probe (T_{win})
12. Pressure gauge (sizes 9.1 to 14.1 only)

- A. Liquid separator
- B. Compressor
- C. 4-way cycle reversing valve
- D. Source side exchanger
- E. Fan
- F. Filter
- G. Laminating valve
- H. Solenoid valve
- I. Capillary
- J. User side exchanger
- K. System expansion vessel
- L. Pressure relief valve
- M. Automatic air vent valve
- N. Flow switch
- O. Water supply pump
- P. Y-filter (supplied as standard, to be installed in the field)
- Q. Liquid receiver (gr. 9.1-14.1 only)

⚠ The diagram refers to operation in Cooling mode

Unit terminology

Parameter	Description
AHS	Backup boiler
IBH	Backup electric heater
P_i	Unit pump or Zone 1 pump (for double zone systems)
P_o	Secondary circuit pump (or Zone 1 pump for double zone systems)
P_c	Zone 2 pump (for double zone systems)
P_d	DHW recirculation pump
P_s	Solar circuit pump
Pe	Evaporation pressure in Cooling mode or condensation pressure in Heating mode
SV1	3-way circuit/DHW diverter valve
SV2	2-way diverter valve for direct 2-zone systems
SV3	3-way mixing valve for mixed circuit
T1	Water supply temperature from additional heating source (with IBH heater or AHS boiler)
T2	Refrigerant temperature entering the user side exchanger (plate heat exchanger) in Cooling mode (or leaving in Heating mode)
T3	Refrigerant temperature leaving the source exchanger (coil) in Cooling mode (or entering in Heating mode)
T4	Outdoor air temperature
T5	DHW tank temperature
T1S	Water supply temperature setpoint
Ta	Room air temperature, detected by the probe in the HMI
Tbt1	Temperature of the upper part of the inertial storage tank
TBH	Backup electric heater for DHW (Domestic Hot Water) storage tank
Th	Compressor suction refrigerant temperature
Tp	Compressor discharge refrigerant temperature
Tsolar	Water temperature in the solar thermal circuit
Tw2	Water supply temperature for the mixed zone (for double zone systems)
TWin	Unit water return temperature
TWout	Unit water supply temperature

General technical data

Heating

SIZES		2.1	3.1	4.1	5.1	6.1 / 6.1T	7.1 / 7.1T	8.1 / 8.1T	9.1	10.1	12.1	14.1
Air 7 °C - Water 35 °C												
Nominal heating capacity	1 kW	4.20	6.35	8.40	10.0	12.1	14.5	15.9	18.0	22.0	26.0	30.1
Total power input	1 kW	0.82	1.28	1.63	2.02	2.44	3.15	3.53	3.83	5.00	6.37	7.70
COP	1 -	5.10	4.95	5.15	4.95	4.95	4.60	4.50	4.70	4.40	4.08	3.91
Water flow-rate	1 l/s	0.20	0.30	0.40	0.48	0.58	0.69	0.76	0.86	1.05	1.25	1.44
Nominal available pressure	1 kPa	85	85	86	86	88	87	87	112	111	111	110
Air 2 °C - Water 35 °C												
Nominal heating capacity	2 kW	4.40	5.50	7.10	8.20	9.20	11.0	13.0	18.0	22.0	24.0	26.0
Total power input	2 kW	1.10	1.41	1.73	2.05	2.36	3.06	3.77	5.33	7.10	8.33	9.29
COP	2 -	4.00	3.90	4.10	4.00	3.90	3.60	3.45	3.38	3.10	2.88	2.80
Water flow-rate	2 l/s	0.21	0.26	0.34	0.39	0.44	0.53	0.62	0.86	1.05	1.15	1.25
Nominal available pressure	2 kPa	85	85	85	85	88	88	87	112	111	111	111
Air -7 °C - Water 35 °C												
Nominal heating capacity	3 kW	4.70	6.00	7.00	8.00	10.0	12.0	13.1	18.0	21.0	22.0	23.0
Total power input	3 kW	1.52	2.00	2.19	2.62	3.33	4.21	4.85	6.67	8.08	8.80	9.39
COP	3 -	3.10	3.00	3.20	3.05	3.00	2.85	2.70	2.70	2.60	2.50	2.45
Water flow-rate	3 l/s	0.23	0.29	0.34	0.38	0.48	0.57	0.63	0.86	1.01	1.05	1.10
Nominal available pressure	3 kPa	85	85	85	85	88	88	87	112	111	111	111
Air 7 °C - Water 45 °C												
Nominal heating capacity	4 kW	4.30	6.30	8.10	10.0	12.3	14.1	16.0	18.0	22.0	26.0	30.0
Total power input	4 kW	1.13	1.70	2.10	2.67	3.32	3.92	4.57	5.14	6.47	8.39	10.3
COP	4 -	3.80	3.70	3.85	3.75	3.70	3.60	3.50	3.50	3.40	3.10	2.90
Water flow-rate	4 l/s	0.21	0.30	0.39	0.48	0.59	0.68	0.77	0.86	1.05	1.25	1.44
Nominal available pressure	4 kPa	85	85	85	86	88	87	87	112	111	111	110
Air 7 °C - Water 55 °C												
Nominal heating capacity	5 kW	4.40	6.00	7.50	9.50	11.9	13.8	16.0	18.0	22.0	26.0	30.0
Total power input	5 kW	1.49	2.03	2.36	3.06	3.90	4.68	5.61	6.55	8.30	10.6	13.0
COP	5 -	2.95	2.95	3.18	3.10	3.05	2.95	2.85	2.75	2.65	2.45	2.30
Water flow-rate	5 l/s	0.21	0.29	0.36	0.45	0.57	0.66	0.77	0.86	1.05	1.25	1.44
Nominal available pressure	5 kPa	85	85	85	86	88	87	87	112	111	111	110

Data according to EN 14511:2018.

1. inlet/outlet water temperature 30/35 °C, outdoor air temperature 7 °C dry bulb / 6 °C wet bulb
2. inlet/outlet water temperature 30/35 °C, outdoor air temperature 2 °C dry bulb / 1 °C wet bulb
3. inlet/outlet water temperature 30/35 °C, outdoor air temperature 7 °C dry bulb / 8 °C wet bulb
4. inlet/outlet water temperature 40/45 °C, outdoor air temperature 7 °C dry bulb / 6 °C wet bulb
5. inlet/outlet water temperature 47/55 °C, outdoor air temperature 7 °C dry bulb / 6 °C wet bulb

Cooling

SIZES		2.1	3.1	4.1	5.1	6.1 / 6.1T	7.1 / 7.1T	8.1 / 8.1T	9.1	10.1	12.1	14.1
Air 35 °C - Water 18 °C												
Nominal cooling capacity	6 kW	4.50	6.50	8.30	9.90	12.0	13.5	14.2	18.5	23.0	27.0	31.0
Total power input	6 kW	0.82	1.35	1.64	2.18	3.04	3.74	3.94	3.90	5.00	6.28	7.75
EER	6 -	5.50	4.80	5.05	4.55	3.95	3.61	3.61	4.75	4.60	4.30	4.00
Water flow-rate	6 l/s	0.22	0.31	0.40	0.47	0.57	0.65	0.68	0.89	1.10	1.29	1.48
Nominal available pressure	6 kPa	85	85	85	86	88	87	87	112	111	111	110
Air 35 °C - Water 7 °C												
Nominal cooling capacity	7 kW	4.70	7.00	7.45	8.20	11.5	12.4	14.0	17.0	21.0	26.0	29.5
Total power input	7 kW	1.36	2.33	2.22	2.52	4.18	4.96	5.60	5.57	7.12	9.63	11.6
EER	7 -	3.45	3.00	3.35	3.25	2.75	2.50	2.50	3.05	2.95	2.70	2.55
Water flow-rate	7 l/s	0.23	0.34	0.36	0.39	0.55	0.59	0.67	0.81	1.01	1.25	1.41
Nominal available pressure	7 kPa	85	85	85	85	88	88	87	112	112	111	111

Data according to EN 14511:2018.

6. inlet/outlet water temperature 23/18 °C, outdoor air temperature 35 °C dry bulb / 27 °C wet bulb
7. inlet/outlet water temperature 12/7 °C, outdoor air temperature 35 °C dry bulb / 27 °C wet bulb

ErP

SIZES			2.1	3.1	4.1	5.1	6.1	7.1	8.1	6.1T	7.1T	8.1T	9.1	10.1	12.1	14.1
Average climatic conditions - Heat pump for Average temperature application																
Nominal power	7	kW	4,4	5,7	6,6	7,7	11,6	11,6	13,0	12,1	12,1	13,0	17,7	22,4	26,2	29,7
SCOP	7	-	3,31	3,52	3,37	3,47	3,45	3,47	3,41	3,45	3,47	3,41	3,20	3,23	3,15	3,15
Generator energy class	7	-	A++	A++	A++	A++	A++	A++	A++	A++	A++	A++	A+	A++	A+	A+
η_s	7	%	129	138	131	137	135	135	133	135	135	133	125	126	123	123
Energy class of gas hybrid system	7	-	A	A	A	A	A	A	A	A	A	A	A	A	A	A
η_s of gas hybrid system	7	%	96	96	96	96	97	96	97	97	96	97	96	96	96	97
Energy class of solar hybrid system	7	-	A++	A++	A++	A++	A++	A++	A++	A++	A++	A++	A++	A++	A++	A++
η_s of solar hybrid system	7	%	158	160	149	152	148	146	143	147	146	143	134	134	130	130
Average climatic conditions - Heat pump for Low temperature application																
Nominal power	8	kW	5,5	6,8	8,1	9,2	12,0	13,7	15,2	12,0	13,7	15,2	18,0	22,3	25,0	29,2
SCOP	8	-	4,85	4,95	5,22	5,20	4,81	4,72	4,62	4,81	4,72	4,62	4,60	4,53	4,5	4,2
Generator energy class	8	-	A+++	A+++	A+++	A+++	A+++	A+++	A+++	A+++	A+++	A+++	A+++	A+++	A+++	A++
η_s	8	%	191	195	205	205	189	186	182	189	186	182	181	179	177	165
Energy class of gas hybrid system	8	-	D	D	D	D	D	D	D	D	D	D	D	D	D	D
η_s of gas hybrid system	8	%	96	96	96	96	96	96	98	96	96	98	96	96	96	97
Energy class of solar hybrid system	8	-	A+++	A+++	A+++	A+++	A+++	A+++	A+++	A+++	A+++	A+++	A+++	A+++	A+++	A++
η_s of solar hybrid system	8	%	221	216	222	219	201	197	192	201	197	192	190	187	184	172
Average climatic conditions - Heat pump for application with Fan coil																
Nominal power	9	kW	4,7	6,4	7,4	8,7	11,3	12,2	14,3	11,3	12,2	14,3	16,6	20,6	25,5	29,5
SEER	9	-	4,99	5,34	5,83	5,98	4,89	4,86	4,69	4,86	4,83	4,67	4,70	4,69	4,66	4,48
η_s	9	%	197	211	230	236	192	191	184	191	190	184	185	185	183	176

The product is conforming with the European ErP Directives, which includes Commission Delegated Regulation (EU) no. 811/2018 and Commission Delegated Regulation no. 813/2018 of the Commission.

Data according to EN 14825

7. Average climate, Medium temperature 47/55 °C

8. Average climate, Low temperature 30/35 °C

9. Average climate, Low temperature 12/7 °C

Technical specifications

SIZES			2.1	3.1	4.1	5.1	6.1 / 6.1T	7.1 / 7.1T	8.1 / 8.1T	9.1	10.1	12.1	14.1		
Refrigeration circuit															
Compressor	no./type	-	1	1	1	1	1	1	1	1	1	1	1		
Oil	type	-	Twin Rotary	Twin Rotary	Twin Rotary	Twin Rotary	Twin Rotary	Twin Rotary	Twin Rotary	Twin Rotary	Twin Rotary	Twin Rotary	Twin Rotary		
	charge	-	ml	460	460	460	460	1100	1100	1100	1500	1500	1500		
Refrigerant	type/GWP	1	-	R-32 / 675											
	charge	-	kg	1,40	1,40	1,40	1,40	1,75	1,75	1,75	5,00	5,00	5,00		
	CO ₂ equiv.	-	t _{CO2}	945	945	945	945	1181	1181	1181	3375	3375	3375		
Number of fans	-	-	1	1	1	1	1	1	1	2	2	2	2		
Water circuit															
Minimum system water content	-	l	30	30	70	70	70	70	70	100	100	100	100		
Admissible water flow rate	minimum	2	l/s	0,11	0,11	0,11	0,11	0,20	0,20	0,20	0,50	0,50	0,50		
	maximum	-	l/s	0,25	0,35	0,46	0,58	0,69	0,76	0,83	1,03	1,26	1,49		
Maximum system pressure	-	bar	3	3	3	3	3	3	3	3	3	3	3		
System expansion vessel	volume	3	l	4,8	4,8	4,8	4,8	4,8	4,8	4,8	4,8	4,8	4,8		
	pre-charge	-	bar	1	1	1	1	1	1	1	1	1	1		
Hydraulic connections	-	inches	1" M	1" M	1 1/4" M	1 1/4" M	1 1/4" M	1 1/4" M	1 1/4" M	1 1/4" M	1 1/4" M	1 1/4" M	1 1/4" M		
Sound data															
Sound pressure at 1 metre	4	dB(A)	41	44	45	46	50	50	53	50	50	53	55		
Sound power	4	dB(A)	55	58	59	60	65	65	68	65	65	68	70		
Dimensions and weights															
Dimensions (Length x Height x Depth)	unit	-	mm	1295x717x426				1385x864x523				1120x1557x528			
	packaging	-	mm	1375x885x475				1465x1035x560				1220x1735x565			
Weight	unit	-	kg	86	86	105	105	129 / 144	129 / 144	129 / 144	177	177	177		
	packaging	-	kg	107	107	132	132	155 / 172	155 / 172	155 / 172	206	206	206		

- it contains fluorinated greenhouse gases
- consider the water content of the area with less volume
- sufficient volume up to a maximum of 60 litres of water content in the system.
- Sound power levels are determined using the intensimetric method (UNI EN ISO 9614-2). Data referring to the following conditions at full load.
Heating: inlet/outlet water temperature 47/55 °C, outdoor air temperature 7 °C.
Cooling: water inlet/outlet temperature 12/7 °C, outdoor air temperature 35 °C.

General technical data

Boilers for stand-alone installations

MODEL				UC 24.4	UC 33.4	FE 24.4	FE 33.4
Heating Performance							
Nominal heat capacity (Qn)	-	Maximum	[kW]	24.0	34.0	24.5	34.8
		Minimum	[kW]	5.0	5.0	4.8	5.0
Heating capacity (Pn)	60/80 °C	Maximum	[kW]	23.4	33.2	24.0	34.0
		Minimum	[kW]	4.8	4.8	4.7	4.9
	30/50 °C	Maximum	[kW]	25.2	35.8	26.0	37.0
		Minimum	[kW]	5.3	5.4	5.2	5.4
Efficiency	60/80 °C	Maximum	%	97.7	97.7	97.8	97.7
		Minimum	%	96.5	96.4	97.6	97.2
	30/50 °C	Maximum	%	105.1	105.2	106.1	106.2
		Minimum	%	106.9	107.0	107.3	107.1
30% of Pn	-	%	108.7	108.6	109.7	109.7	
Boiler water content	-	-	[l]	2.5	2.8	3.4	4.3
Operating pressure	PMS	Maximum	[bar]	3	3	3	3
	-	Minimum	[bar]	0.5	0.5	0.8	0.8
Expansion tank	Volume	-	[l]	10	10	8	10
	Pre-charge	-	[bar]	1	1	0.8	0.8
DHW performance							
Nominal heat capacity (Qnw)	-	Maximum	[kW]	28.0	34.0	28.5	34.8
		Minimum	[kW]	5.0	5.0	4.7	5.0
Heating capacity	-	Maximum	[kW]	27.3	33.2	28.0	34.0
		Minimum	[kW]	4.8	4.8	4.7	4.8
DHW flow rate	ΔT=25 °C	-	[l/min]	16.2	19.2	16.1	19.5
	ΔT=30 °C	-	[l/min]	13.5	16.0	13.4	16.2
	ΔT=45 K	-	[l/min]	9.0	10.6	8.9	10.8
DHW production in continuous operation	ΔT=40 K	-	[l/min]	10.1	11.9	10.0	12.1
	ΔT=35 K	-	[l/min]	11.6	13.6	11.5	13.9
	ΔT=30 K	-	[l/min]	13.5	15.8	13.4	16.2
	ΔT=25 K	-	[l/min]	16.2	19.0	16.1	19.5
Water temperature		Maximum	[°C]	60	60	65	65
		Minimum	[°C]	38	38	40	40
Operating pressure	PMW	Maximum	[bar]	6	6	9	9
	-	Minimum	[bar]	0.5	0.5	0.3	0.3
ErP data							
Seasonal eff. Average climate	Heating	ηs	%	93	93	94	94
		Energy class	-	A	A	A	A
	DHW	ηwh	%	87	90	85	85
		Energy class	-	A	A	A	A
		Withdrawal profile	-	XL	XL	XL	XXL
Sound power level		Lwa	[dB(A)]	53	56	49	52
Thermal losses and discharge of flue gas							
Flue loss	burner ON 80/60 °C	Pmax	%	2.33	2.27	2.00	2.10
		Pmin	%	2.24	2.32	2.00	2.90
	burner ON 50/30 °C	Pmax	%	1.70	1.15	1.40	1.40
		Pmin	%	1.37	1.44	1.00	1.00
Flue gas temperature	80/60 °C	Pmax	[°C]	66.5	64.9	66	67
		Pmin	[°C]	64.3	65.9	64	62
	50/30 °C	Pmax	[°C]	53.6	52.7	52	53
		Pmin	[°C]	47.2	48.4	44	45
Flue gas flow rate	-	Pmax	[g/s]	13.8	15.6	11.2	16
	-	Pmin	[g/s]	2.3	2.3	2.3	2.4
Nitrogen oxide (NOX) emissions		Class	-	6	6	6	6
		-	[mg/kWh]	45	49	35	33

Boilers for centralised systems

MODEL			UC 70.2	UC 115.2	UC 200.2		
Heating Performance							
Modulation ratio	-	-	-	1: 7	1: 5.75	1: 10	
Nominal heat capacity (Qn)	-	Maximum	[kW]	67.5	115.0	199.0	
		Minimum	[kW]	9.6	20.0	20.0	
Heating capacity (Pn)	60/80 °C	Maximum	[kW]	65.7	111.5	194.8	
		Minimum	[kW]	9.1	19.2	19.1	
	30/50 °C	Maximum	[kW]	68.7	120.0	205.2	
		Minimum	[kW]	10.3	21.8	21.1	
Efficiency	60/80 °C	Maximum	%	97.3	97.1	97.9	
		Minimum	%	94.9	95.9	95.6	
	30/50 °C	Maximum	%	101.7	104.6	103.1	
		Minimum	%	107.6	108.8	105.4	
	30% of Pn	-	%	107.3	107.3	108.9	
Combustion efficiency	Reduced load		%	98.3	98.3	98.2	
	Nominal load		%	97.4	97.7	98.0	
Water content			[l]	3.9	9.0	22.0	
Operating pressure	PMS	Maximum	[bar]	6	6	6	
	-	Minimum	[bar]	0.5	0.5	0.5	
ErP data							
Seasonal eff.	Heating	ηs	%	93	92	93	
Average climate		Energy class	-	A	A	A	
Sound power level			Lwa	[dB(A)]	63	-	-
Thermal losses and discharge of flue gas							
Casing losses	burner ON	Qn	%	0.09	0.7	0.14	
		Qmin	%	3.44	2.69	2.60	
Flue loss	burner ON	Pmax	%	2.62	2.29	2.00	
		Pmin	%	1.66	1.87	1.80	
Flue gas temperature (T _f -T _a)			Pmax	[°C]	51.3	46.6	40
			Pmin	[°C]	34	36	34
Flue gas flow rate	-	Pmax	[g/s]	111.4	184.6	319.57	
		Pmin	[g/s]	15.9	34.3	34.3	
Nitrogen oxide (NOx) emissions			Class	-	6	6	6
			-	[mg/kWh]	59	47	68

“Factory made” hybrid combinations

	Heat pumps		Compatible boiler				
	Combination	Power	24.4	33.4	70.2	115.2	200F.2
1 unit	2.1	kW 4.20	✓	✓	✓	✓	✓
	3.1	kW 6.35	✓	✓	✓	✓	✓
	4.1	kW 8.40	✓	✓	✓	✓	✓
	5.1	kW 10.0	✓	✓	✓	✓	✓
	6.1	kW 12.1	-	✓	✓	✓	✓
	7.1	kW 14.5	-	✓	✓	✓	✓
	8.1	kW 15.9	-	✓	✓	✓	✓
	9.1	kW 18.0	-	-	✓	✓	✓
	10.1	kW 22.0	-	-	✓	✓	✓
	12.1	kW 26.0	-	-	✓	✓	✓
	14.1	kW 30.1	-	-	✓	✓	✓
	2.1+2.1	kW 8.4	✓	✓	✓	✓	✓
	3.1+3.1	kW 12.7	-	✓	✓	✓	✓
	4.1+4.1	kW 16.8	-	-	✓	✓	✓
2 units (cascade)	5.1+5.1	kW 20.0	-	-	✓	✓	✓
	6.1+6.1	kW 24.2	-	-	✓	✓	✓
	7.1+7.1	kW 29.0	-	-	✓	✓	✓
	8.1+8.1	kW 31.8	-	-	✓	✓	✓
	9.1+9.1	kW 36.0	-	-	-	✓	✓
	10.1+10.1	kW 44.0	-	-	-	✓	✓
	12.1+12.1	kW 52.0	-	-	-	✓	✓
	14.1+14.1	kW 60.2	-	-	-	-	✓
	2.1+2.1+2.1	kW 12.6	-	✓	✓	✓	✓
	3.1+3.1+3.1	kW 19.1	-	-	✓	✓	✓
	4.1+4.1+4.1	kW 25.2	-	-	✓	✓	✓
	5.1+5.1+5.1	kW 30.0	-	-	✓	✓	✓
	6.1+6.1+6.1	kW 36.3	-	-	-	✓	✓
	7.1+7.1+7.1	kW 43.5	-	-	-	✓	✓
8.1+8.1+8.1	kW 47.7	-	-	-	✓	✓	
9.1+9.1+9.1	kW 54.0	-	-	-	-	✓	
10.1+10.1+10.1	kW 66.0	-	-	-	✓	✓	
12.1+12.1+12.1	kW 78.0	-	-	-	-	✓	
14.1+14.1+14.1	kW 90.3	-	-	-	-	✓	
3 units (cascade)	2.1+2.1+2.1+2.1	kW 16.8	-	-	✓	✓	✓
	3.1+3.1+3.1+3.1	kW 25.4	-	-	✓	✓	✓
	4.1+4.1+4.1+4.1	kW 33.6	-	-	-	✓	✓
	5.1+5.1+5.1+5.1	kW 40.0	-	-	-	✓	✓
	6.1+6.1+6.1+6.1	kW 48.4	-	-	-	✓	✓
	7.1+7.1+7.1+7.1	kW 58.0	-	-	-	-	✓
	8.1+8.1+8.1+8.1	kW 63.6	-	-	-	-	✓
	9.1+9.1+9.1+9.1	kW 72.0	-	-	-	-	✓
	10.1+10.1+10.1+10.1	kW 88.0	-	-	-	-	✓
	12.1+12.1+12.1+12.1	kW 104.0	-	-	-	-	-
	14.1+14.1+14.1+14.1	kW 120.4	-	-	-	-	-
	2.1+2.1+2.1+2.1+2.1	kW 21.0	-	-	✓	✓	✓
	3.1+3.1+3.1+3.1+3.1	kW 31.8	-	-	✓	✓	✓
	4.1+4.1+4.1+4.1+4.1	kW 42.0	-	-	-	✓	✓
5.1+5.1+5.1+5.1+5.1	kW 50.0	-	-	-	✓	✓	
6.1+6.1+6.1+6.1+6.1	kW 60.5	-	-	-	-	✓	
7.1+7.1+7.1+7.1+7.1	kW 72.5	-	-	-	-	✓	
8.1+8.1+8.1+8.1+8.1	kW 79.5	-	-	-	-	✓	
9.1+9.1+9.1+9.1+9.1	kW 90.0	-	-	-	-	✓	
10.1+10.1+10.1+10.1+10.1	kW 110.0	-	-	-	-	-	
12.1+12.1+12.1+12.1+12.1	kW 130.0	-	-	-	-	-	
14.1+14.1+14.1+14.1+14.1	kW 150.5	-	-	-	-	-	
2.1+2.1+2.1+2.1+2.1+2.1	kW 25.2	-	-	✓	✓	✓	
3.1+3.1+3.1+3.1+3.1+3.1	kW 38.1	-	-	-	✓	✓	
4.1+4.1+4.1+4.1+4.1+4.1	kW 50.4	-	-	-	✓	✓	
5.1+5.1+5.1+5.1+5.1+5.1	kW 60.0	-	-	-	-	✓	
6.1+6.1+6.1+6.1+6.1+6.1	kW 72.6	-	-	-	-	✓	
7.1+7.1+7.1+7.1+7.1+7.1	kW 87.0	-	-	-	-	✓	
8.1+8.1+8.1+8.1+8.1+8.1	kW 95.4	-	-	-	-	✓	
9.1+9.1+9.1+9.1+9.1+9.1	kW 108.0	-	-	-	-	-	
10.1+10.1+10.1+10.1+10.1+10.1	kW 132.0	-	-	-	-	-	
12.1+12.1+12.1+12.1+12.1+12.1	kW 156.0	-	-	-	-	-	
14.1+14.1+14.1+14.1+14.1+14.1	kW 180.6	-	-	-	-	-	

Electric data

Sizes			2.1	3.1	4.1	5.1	6.1	7.1	8.1	6.1T	7.1T	8.1T	9.1	10.1	12.1	14.1
Power supply	1	V/Hz/p					230/50/1				400/50/3+N					
Standard Unit																
F.L.I. - Power input at max admissible conditions	-	kW	2.3	2.7	3.4	3.7	5.5	5.8	6.2	5.5	5.8	6.2	10.6	12.5	13.8	14.5
F.L.A. - Absorbed current at maximum admissible conditions	-	A	12.0	14.0	16.0	17.0	25.0	26.0	27.0	10.0	11.0	12.0	21.0	24.5	27.0	28.5
IBH configuration: built-in additional electric heater																
F.L.I. - Power input at max admissible conditions	2	kW	5.6	6.0	6.7	7.0	8.8	9.1	9.5	15.4	15.7	16.1	-	-	-	-
F.L.A. - Absorbed current at maximum admissible conditions	2	A	24.3	26.1	29.1	30.4	38.3	39.6	41.3	67.0	68.3	70.0	-	-	-	-

Boilers for hybrid versions

Model			FE 24.4	FE 33.4	UC 24.4	UC 33.4	UC 70.2	UC 115.2	UC 200F.2
Power supply	-	[V-Hz]	230/50	230/50	230/50	230/50	230/50	230/50	230/50
F.L.A. - Absorbed current at maximum admissible conditions	2	[A]	0.41	0.53	0.36	0.43	1.16	1.37	2.52
F.L.I. - Power input at max admissible conditions	2	[kW]	0.095	0.122	0.082	0.099	0.267	0.314	0.58
Protection rating	IP	-	X5D	X5D	X4D	X4D	X4D	X5D	X5D

Accessories

ACS200X / ACS300X / ACS500X TBH and QERAX heater	F.L.I.	4	kW	2.10
	F.L.A.	4	A	9.13
ACS1000X / ACS10SX - TBH and QERATX heater	F.L.I.	4	kW	4.73
	F.L.A.	4	A	6.82
IBHX	F.L.I.	3-4	kW	6.6
	F.L.A.	3-4	A	28.7
IBHTX	F.L.I.	3-4	kW	9.9
	F.L.A.	3-4	A	14.3
DTX - antifreeze heater	F.L.I.	2	W	110
	F.L.A.	2	mA	480
KIRE2HX / KIRE2HLX - two identical circulators	F.L.I.	4	W	90
	F.L.A.	4	mA	880
KCSX - circulator	F.L.I.	4	W	60
	F.L.A.	4	mA	580
PRSX - circulator	F.L.I.	4	W	76
	F.L.A.	4	mA	330
PCSX - circulator	F.L.I.	4	W	52
	F.L.A.	4	mA	520
PCS2X - circulator	F.L.I.	4	W	140
	F.L.A.	4	mA	1100

The units comply with the requirements of European standard IEC EN 60335.

- permissible power supply: 220-240V±10% and 380-415V±6%.
- data to be added to standard unit values
- data on the maximum installable power (3 stages). It is possible to power 1 or 2 stages and the electrical sizing values are proportional to the number of stages
- the application requires independent power supply: data required for sizing the relevant power lines

The tanks are supplied with immersed electric heater

⚠ When defining the size, make sure all absorption values are compliant with current power supply contracts in the country of installation.

Current data for *Power limitation* function

This function is used to limit the current consumed by the unit according to predefined profiles, which can be set at 0-8.

Maximum current limitation [A] according to the selected profile:

SIZES	#							
	1	2	3	4	5	6	7	8
2.1 TO 3.1	18	16	15	14	13		12	
4.1 TO 5.1	19	18	16	14			12	
6.1M-7.1M	30	28	26	24	22	20	18	16
8.1M	30	29	27	25	23	21	19	17
6.1T-8.1T	14	13	12	11	10		9	
9.1	18	17	16	15	14	13	12.5	12
10.1	21	20	19	18	17	16	15	14
12.1	24	23	22	21	20	19	18	17
14.1	28	27	26	25	24	23	22	21

⚠ By enabling the function, the performance of the unit will be less than the nominal one.

Sound levels

SIZES			2.1	3.1	4.1	5.1	6.1	7.1	8.1	6.1T	7.1T	8.1T	9.1	10.1	12.1	14.1	
Sound power	standard	-	dB(A)	55	58	59	60	65	65	68	65	65	68	70	72	74	77
	silent	1	dB(A)	54	56	56	57	61	61	63	61	61	63	66	64	71	75
	supersilent	2	dB(A)	53	55	54	55	59	59	59	59	59	59	63	62	70	73
Sound pressure @1m	standard	-	dB(A)	41	44	45	46	50	50	53	50	50	53	55	56	58	61
	silent	1	dB(A)	40	42	42	42	46	46	48	46	46	48	51	48	55	59
	supersilent	2	dB(A)	39	41	40	40	44	44	44	44	44	44	48	46	54	57

Sound power level

SIZE	Octave bands (Hz)							
	63	125	250	500	1000	2000	4000	8000
2.1	64	58	54	53	51	45	38	34
3.1	64	58	54	53	52	45	38	34
4.1	68	69	58	56	52	49	48	39
5.1	69	65	61	57	53	52	49	42
6.1	73	66	63	63	60	56	48	42
7.1	73	68	62	63	59	57	50	44
8.1	78	78	64	65	62	59	51	47
6.1T	70	69	63	62	60	57	54	53
7.1T	71	72	64	60	58	57	57	54
8.1T	76	73	64	64	62	61	58	53
9.1	71	79	70	67	64	61	53	50
10.1	75	76	71	69	66	64	57	54
12.1	76	79	73	71	68	66	59	56
14.1	75	81	77	73	71	69	61	57

The sound levels refer to a unit at full load, under nominal test conditions.

Reference conditions: inlet/outlet water temperature 47/55 °C, outdoor air temperature 7 °C dry bulb / 6 °C wet bulb

The noise level is determined using the tensiometric method (UNI EN ISO 9614-2)

The sound pressure level refers to 1 m. from the unit outer surface operating in open field.

- use a correction factor of 0.8 to calculate the maximum capacity delivered in Silent mode
- use a correction factor of 0.6 to calculate the maximum capacity delivered in Super-Silent mode

Note: Silent and Supersilent functions are designed for temporary unit operations

Operating range

Heating / DHW

2.1 to 8.1

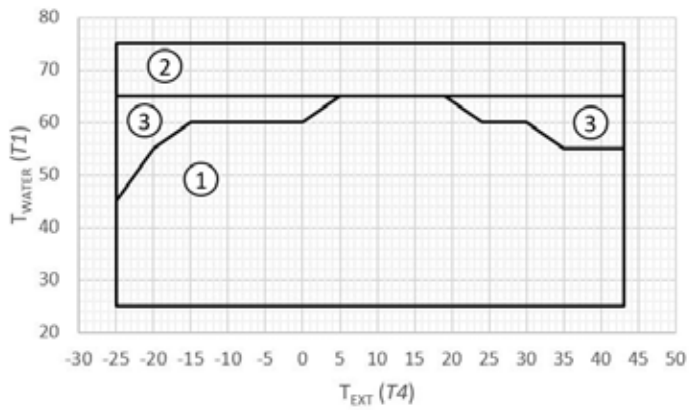

9.1 to 14.1

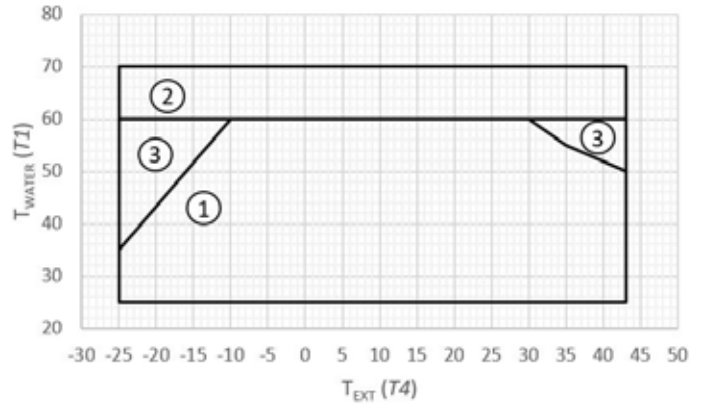

1. Heating / DHW in heat pump only
2. Back-up / additional with boiler
3. Back-up / additional with electric heater

Note: the operating range in DHW mode can be limited by the DHW control logic

Cooling

2.1 to 8.1

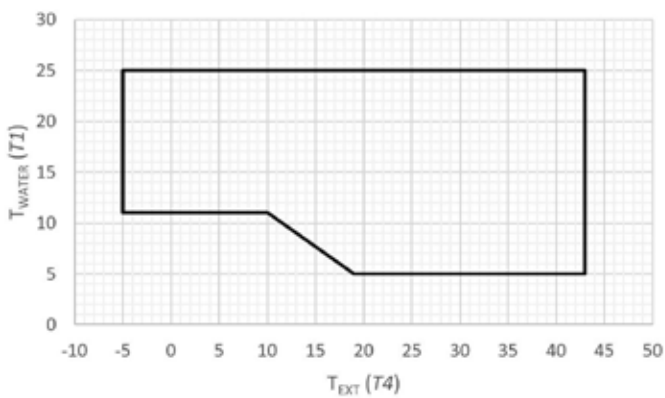

9.1 to 14.1

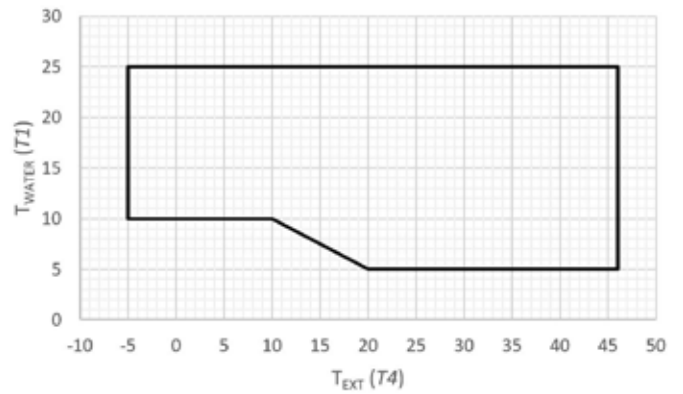

T_{water} (T1): water supply temperature
T_{ext} (T4): outdoor air temperature

Available pressure

Standard Unit

2.1 to 8.1

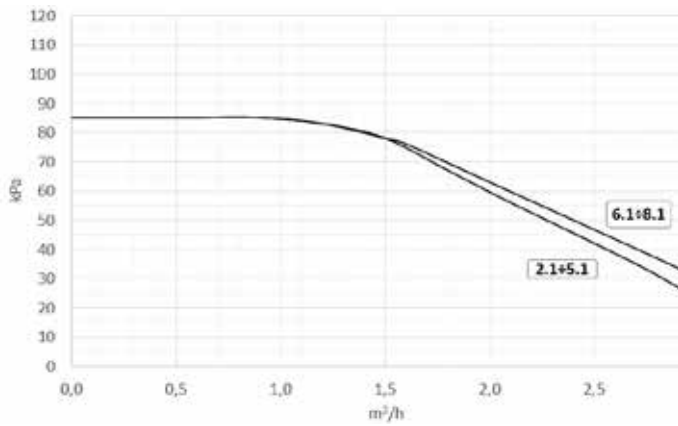

9.1 to 14.1

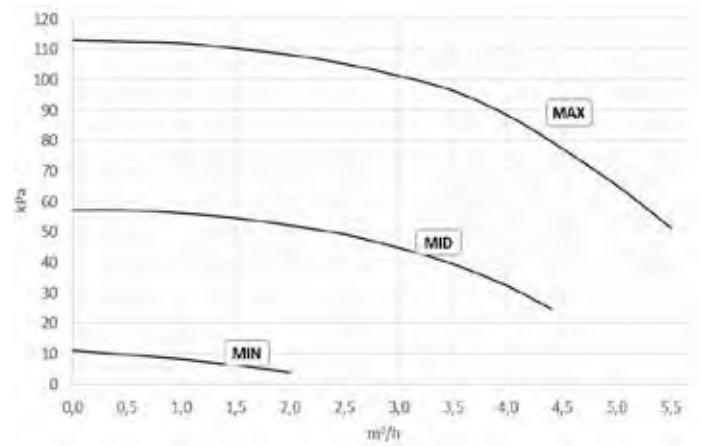

Note: it is advisable to install a hydraulic separator

Boilers for hybrid versions

GAS BOILER_FE 24.4-33.4

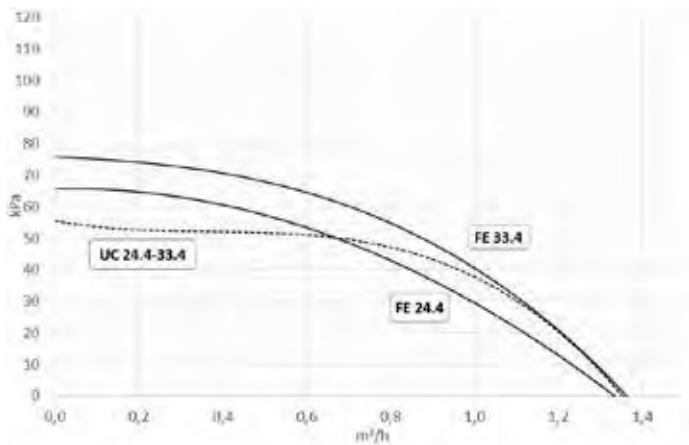

GAS BOILER_UC 70.2-200F.2

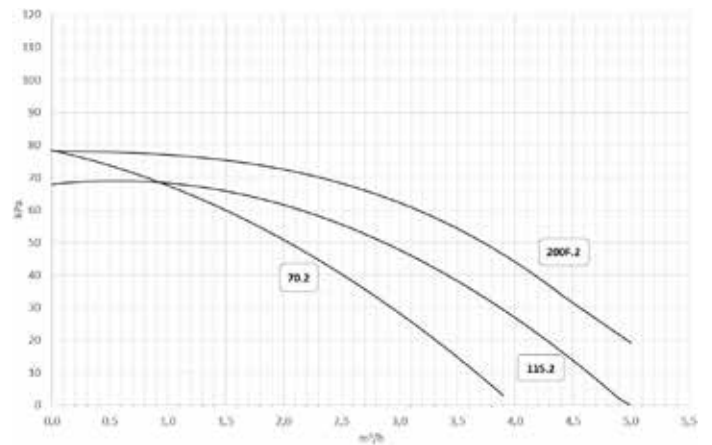

Accessories

PCSX / PCS2X

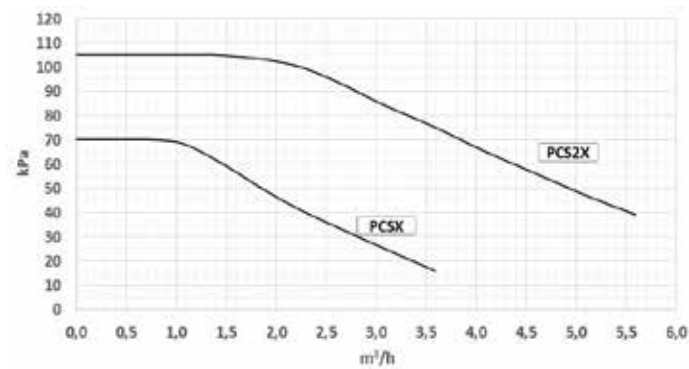

PRSX

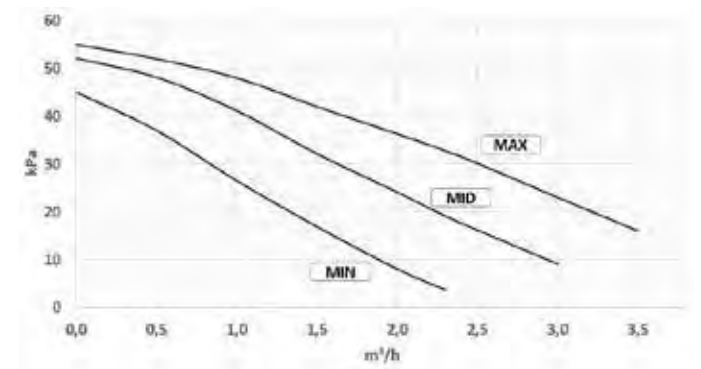

Note: the circulators for the secondary circuit can be set with 3 curves at constant speed, or 3 curves at proportional head or constant head. The curve shown represents operation with the limit curve at constant speed

kPa: available pressure
m³/h: water flow

Hydraulic data

KIRE2HX / KIRE2HLX - two zone kit and KCSX - kit for secondary circuit

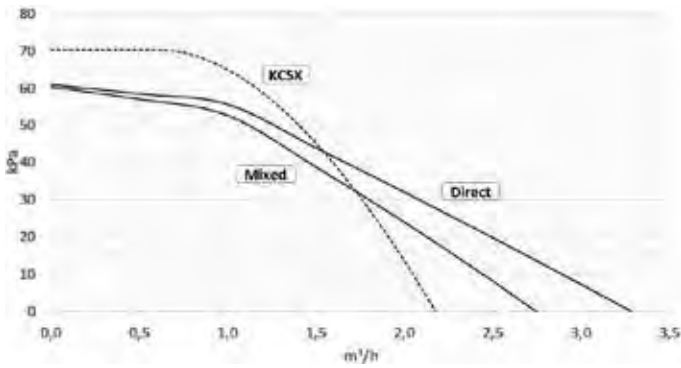

kPa: available pressure
m³/h: water flow

Note: the circulators in the two-zone kit can be adjusted with either 3 constant speed curves or 3 proportional pressure drop curves. The curve shown represents operation with the limit curve at constant speed

Pressure drops of the accessories

3DHWX - 3-way switching valve

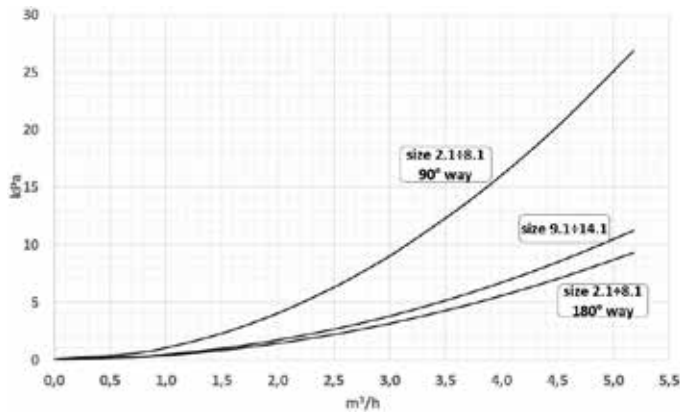

Note: pressure drops refer to the valve body only, without any fittings
Valves for sizes 2.1-8.1 have a 90° way for DHW and a 180° way for the system, while valves for sizes 9.1-14.1 have a 90° way for both the system and DHW.

Boilers - standard

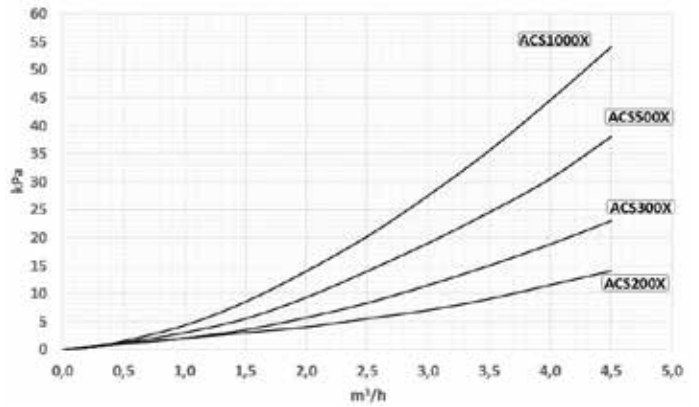

Boilers - with solar coil

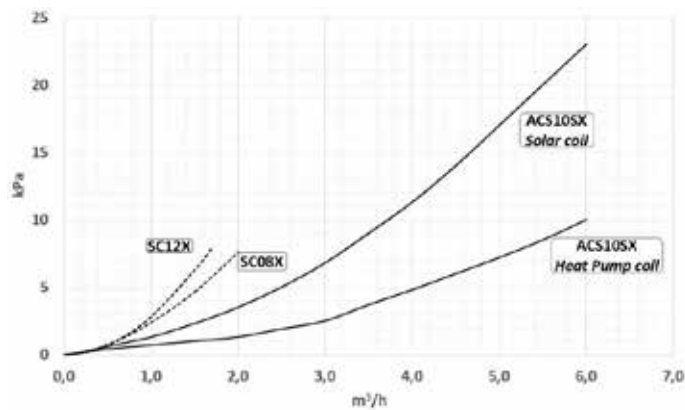

VDACSX

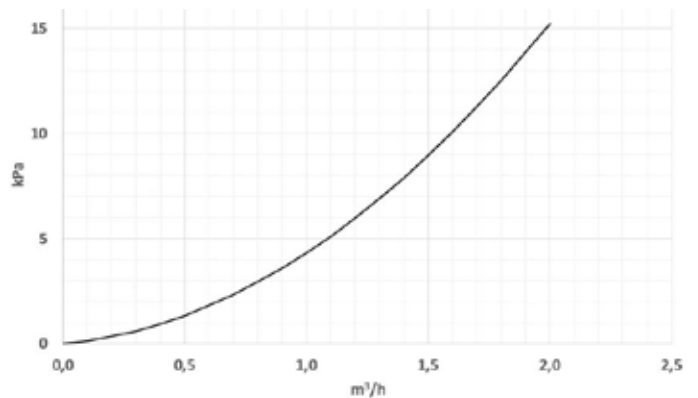

Note: pressure drops refer to the valve body only, without any fittings

kPa: pressure drops
m³/h: water flow

FDMX

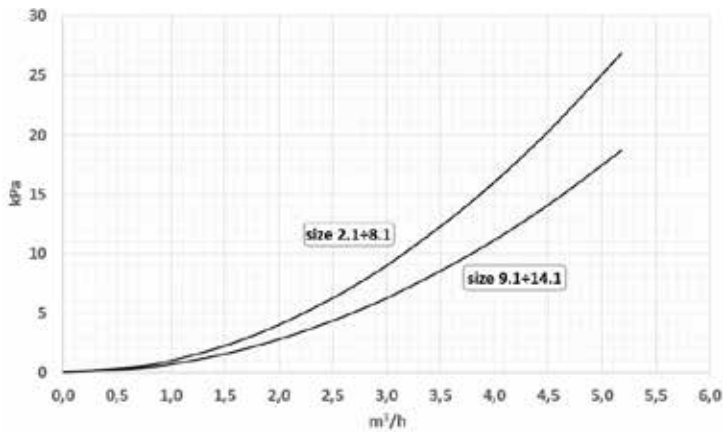

Note: pressure drops refer to the valve body only, without any fittings
 Note: IBH, IBHX and IBHTX have negligible pressure drops

Components that can be managed by the unit

The unit can communicate, receive information and manage a number of system and control components:

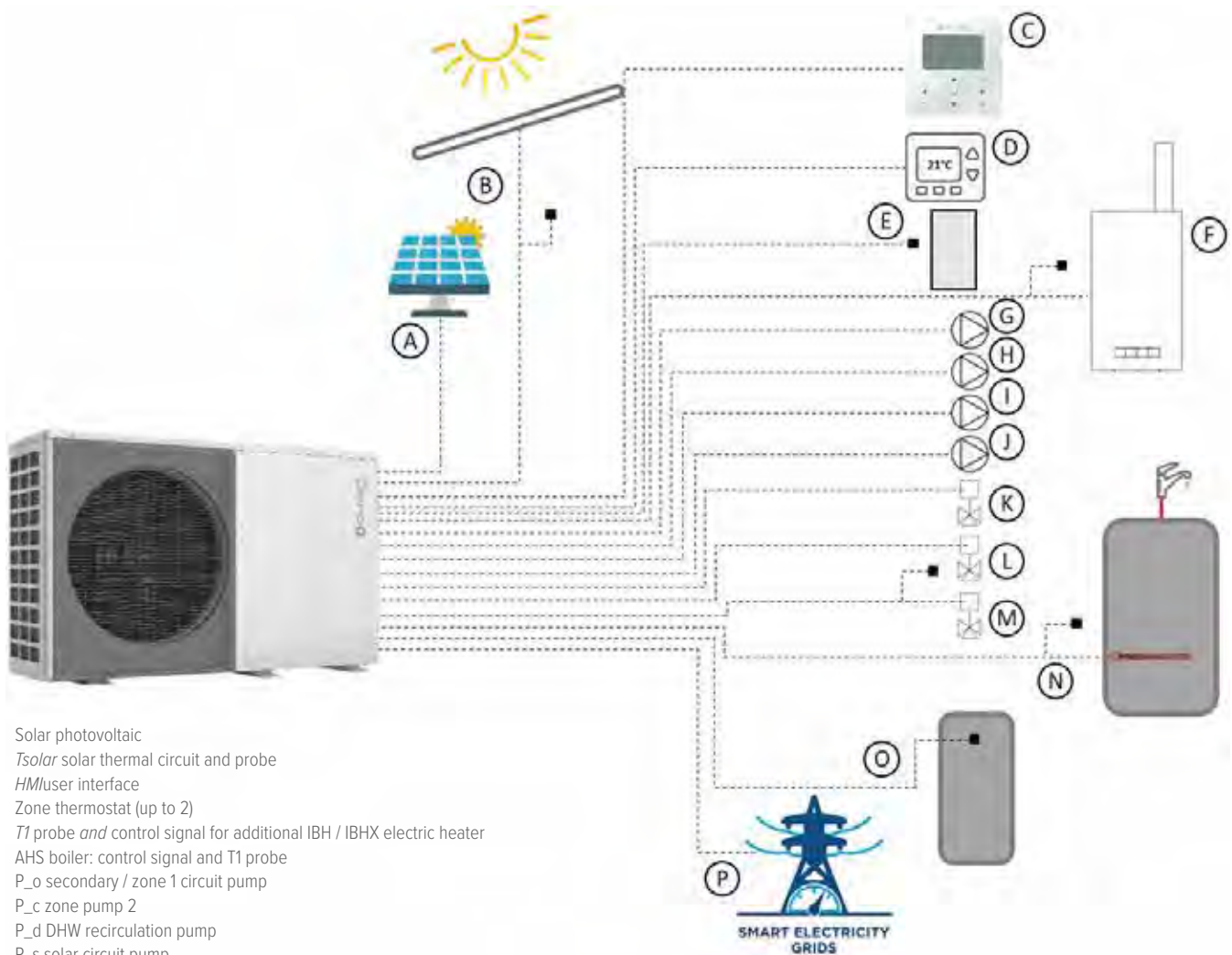

- A. Solar photovoltaic
- B. Solar solar thermal circuit and probe
- C. HM/user interface
- D. Zone thermostat (up to 2)
- E. T1 probe and control signal for additional IBH / IBHX electric heater
- F. AHS boiler: control signal and T1 probe
- G. P_o secondary / zone 1 circuit pump
- H. P_c zone pump 2
- I. P_d DHW recirculation pump
- J. P_s solar circuit pump
- K. SV1 circuit / DHW switching 3-way valve
- L. SV2 2-way switching valve for direct 2-zone systems
- M. Zone 2 mixed management: SV3 3-way switching valve for mixed circuit and Tw2 probe
- N. DHW boiler: TBH heater and T5 probe management signal
- O. Hydraulic separator: Tbt1 probe
- P. Smart Grid

User interface (HMI)



Resolution	1° C	
Temperature sensor	NTC 5k 1%	
Power input	< 1 W	
Storage temperature	Storage	-10 to 50 °C
Communication	RS485	
Wiring	Type	Shielded cable
	MAX length	100 m

The unit is equipped with a user interface (HMI) to be installed in the field, for managing the functions, and with a built-in temperature probe for possible use as a thermostat.

The user interface comes as standard with 16 selectable languages: Italian / English / French / Spanish / Polish / Portuguese / German / Dutch / Romanian / Russian / Turkish / Greek / Swedish / Slovenian / Czech / Slovak.

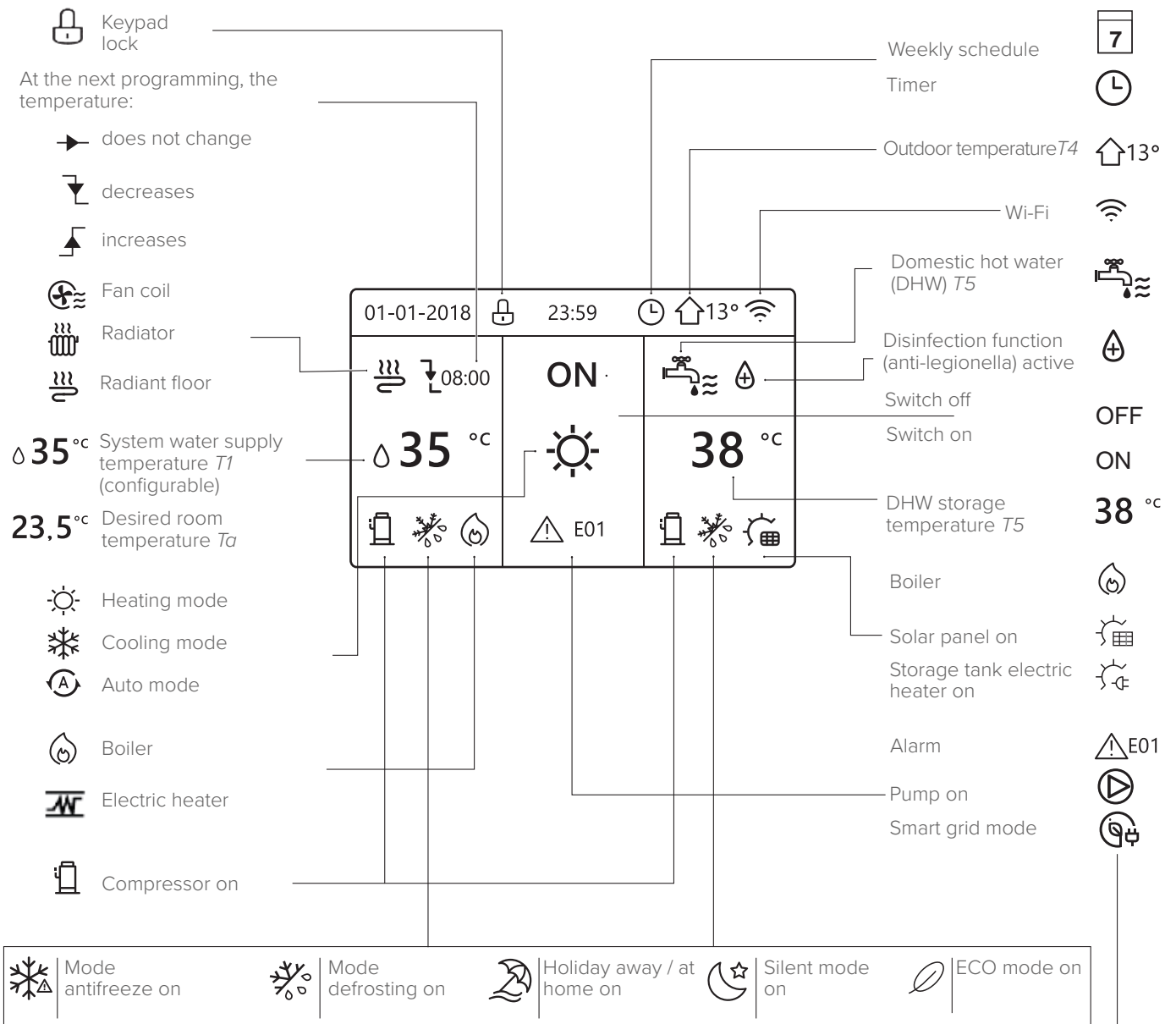

	Fan coil	Radiator	Radiant panels	DHW
ON				
OFF				

	Free	From the network	Peak
Smart grid			

DHW boiler

As an option, the unit can be connected to a DHW storage tank of suitable volume, by fitting the system with a 3-way diverter valve controlled by the unit.

It is advisable to connect the DHW tank at a distance of no more than 10 m from the unit, and preferably as close as possible to the unit. The sizing of the connecting pipes and their thermal insulation must always be considered with care, especially in the case of long distances between the unit and the storage tank.

The standard boiler must have these characteristics:

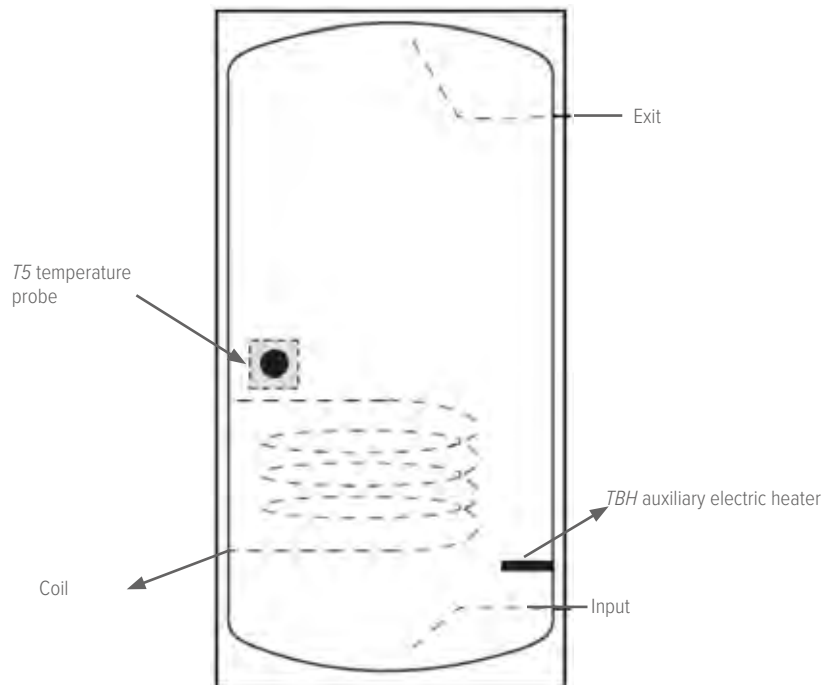

It is also possible to connect a boiler with additional coil for solar thermal circuit with these features:

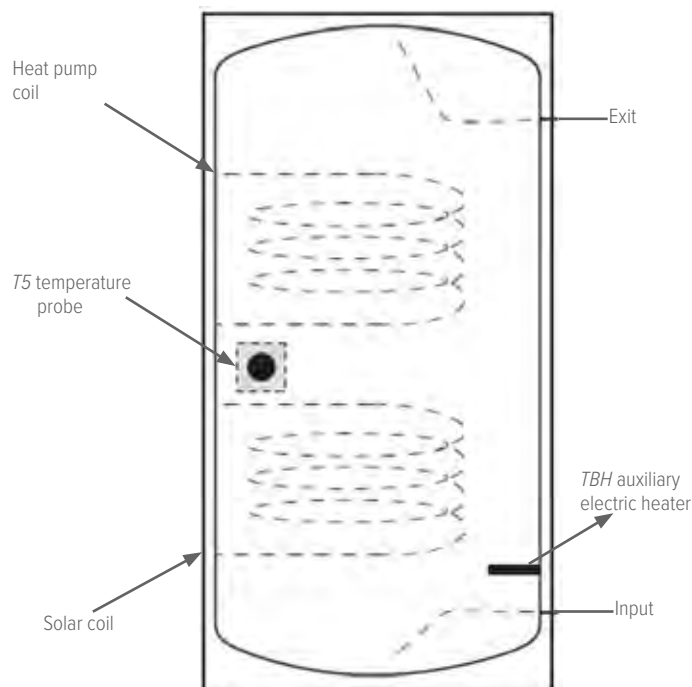

In the case of a boiler from another supply, it is advisable to select one with a stainless steel tank, sacrificial anode and integrated auxiliary electric heater.

You can therefore select the QERAX or QERATX kits or alternatively use an equivalent auxiliary panel: a dedicated power supply is required in any case.

The requirements for optimal selection are:

		2.1 TO 3.1	4.1 TO 5.1	6.1 TO 8.1	9.1 TO 14.1
Tank volume	l	100 to 250	150 to 300	200 to 500	500 to 1000
Minimum surface area of the coil (stainless steel tank)	m ²	1.4	1.4	1.6	2.5
Minimum surface area of the coil (enamelled steel tank)	m ²	2	2	2.5	3.5

Main functions

The user interface (HMI) has intuitive setting sub-menus and allows most of the unit's functions to be managed during start-up or subsequent operation.

FOR SERVICEMAN 1/3	
1. DHW MODE SETTING	
2. COOL MODE SETTING	
3. HEAT MODE SETTING	
4. AUTO MODE SETTING	
5. TEMP. TYPE SETTING	
6. ROOM THERMOSTAT	
OK ENTER	

FOR SERVICEMAN 2/3	
7. OTHER HEATING SOURCE	
8. HOLIDAY AWAY MODE SET	
9. SERVICE CALL SETTING	
10. RESTORE FACTORY SETTING	
11. TEST RUN	
12. SPECIAL FUNCTION	
OK ENTER	

FOR SERVICEMAN 3/3	
13. AUTO RESTART	
14. POWER INPUT LIMITATION	
15. INPUT DEFINE	
16. CASCADE SET	
17. HMI ADDRESS SER	
OK ENTER	

DHW (Domestic Hot Water) settings and management

The unit is designed to be coupled to DHW storage boilers(HMI-enabled), connected with the heater management kit (QERAX or QERATX) and T5 probe.

Logic dictates that there is a demand for DHW when the difference between the DHW set-point T5S and the temperature of the storage tank T5 is greater than or equal to the value dT5_ON (default 10 °C, can be adjusted to 1-30)

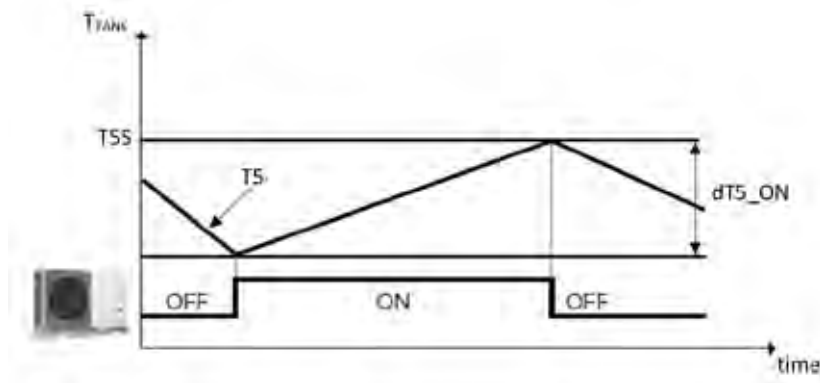

Operation of the unit in DHW mode ends when $T5 \geq T5S$ or when T5 reaches the maximum temperature for DHW in the heat pump T5stop, which is parameterised according to the outdoor temperature T4:

T4 [°C]	43 TO 40	40 TO 35	35 TO 30	30 TO 25	25 TO 20	20 TO 15	15 to 10
2.1 TO 8.1			50	55	56	57	
9.1 TO 14.1	45	48	48	50	53	55	

T4 [°C]	10 TO 5	5 TO 0	0 TO -5	-5 TO -10	-10 TO -15	-15 TO -20	<-20
2.1 TO 8.1	56	55	52	50			
9.1 TO 14.1	55	53	50	48	45	40	35

Sizes 2.1 to 8.1

Sizes 9.1 to 14.1

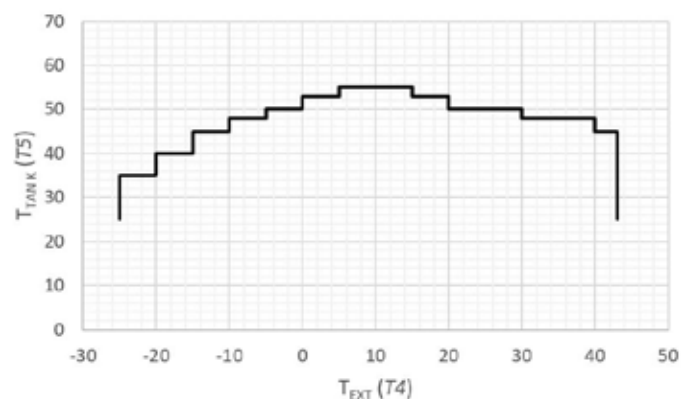
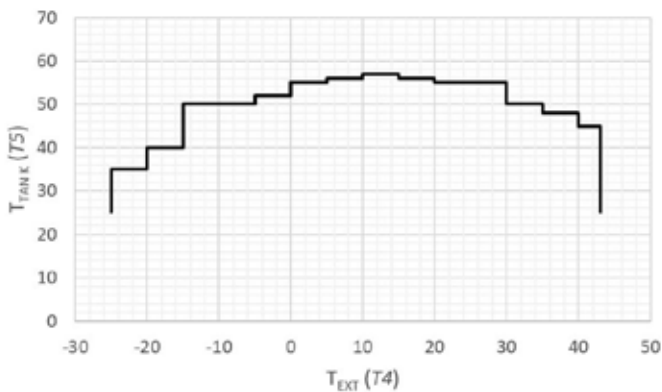

If there is a further demand for DHW beyond T5stop, the unit can activate the TBH boiler heater until setpoint T5S is reached.

In DHW mode, the heat pump delivers water at $T_{wout} = T_5 + dt1S5$, where the parameter $dt1S5$ (default 10 °C, can be adjusted to 5-40) can be set from the HMI. Irrespective of how the parameter is set, the heat pump in Full Electric mode can deliver water up to 65 °C (60 °C for sizes 9.1-14.1), and up to 75 °C (70 °C for sizes 9.1-14.1) in hybrid systems in which there is an additional boiler driven by the unit itself.

The outdoor air temperature range T4 within which the heat pump can operate in DHW mode adjusting it between T4DHWMIN (default -10 °C, can be adjusted to between -25 and 30) and T4DHWMAX (default 43 °C, can be adjusted to 35-43). Outside the operating range set in this way, but within the generic operating range of the heat pump, the unit can produce DHW with the heater of the TBH DHW storage tank.

If there is simultaneous demand from DHW and the system, the former has priority as standard, but this can be changed at the HMI. However, the unit's logic controls several parameters and alternates between DHW and system operation in order to preserve comfort.

In particular, two controls can be activated, which process the maximum operating time of the unit in the system before switching to DHW $t_{DHWHP_RESTRICT}$ (default 30min, can be adjusted to 10-600) and the maximum operating time of the unit in DHW mode before switching to system t_{DHWHP_MAX} (default 90min, can be adjusted to 10-600).

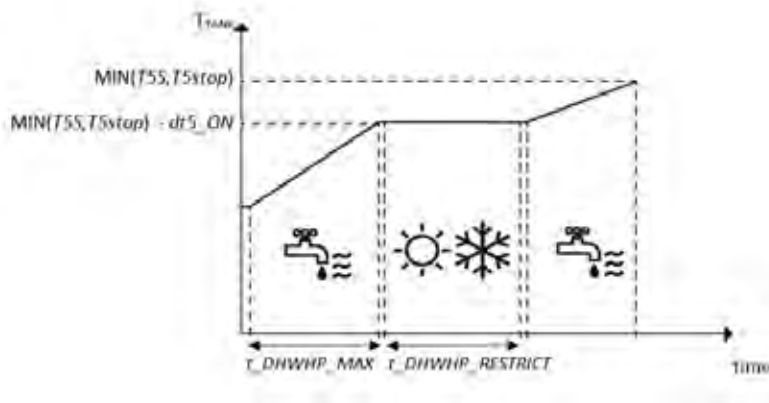

By default, when the compressor of the unit is stopped, the heat pump waits a minimum of 5 minutes for it to be reactivated.

Other functions related to the production of DHW are:

- DISINFECT: management of periodic antilegionella cycles (to be enabled, with logic as per the diagram)

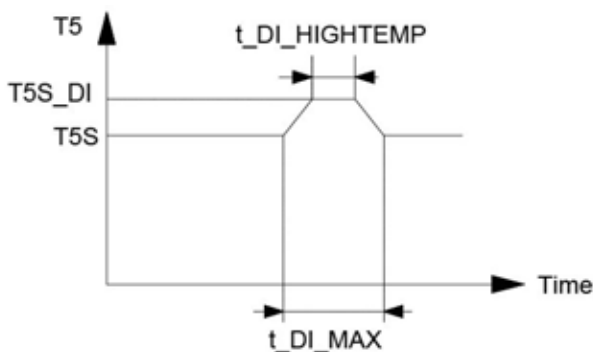

Parameters that can be set on the HMI:

T5S_DI (standard: 65 - can be set from: 60-70)

temperature to which the unit must bring the DHW tank in anti-legionella mode

$t_{DI_HIGHTEMP}$ (standard: 15 - can be set from: 5-60)

minutes during which the temperature T5S_DI must be kept in anti-legionella mode

t_{DI_MAX} (standard: 210 - can be set from: 90-300)

maximum minutes during which the unit can remain in anti-legionella mode

Note: it is important to set the heater safety thermostat above the anti-legionella cycle temperature set point T5S_DI, so that the cycle can be completed.

- FAST DHW: forces the unit and the heater of the TBH boiler to run in DHW mode up to the set-point
- TANK WATER: forces the heater of the TBH boiler to run in DHW mode, letting the unit of the system to work or act as a back-up in case of failure
- DHW PUMP: cycle programme for the DHW recirculation pump. The recirculation pump must be enabled at the HMI (parameter PUMP_D TIMER), selecting whether it should also work during anti-legionella cycles (parameter PUMP_D DISINFECT RUN), and setting the time of operation in minutes when activated in PUMP_D RUNNING TIME (standard: 5 - can be set from: 5-120)

Main functions

Type of system adjustment and request to unit

During the initial start-up phase, the type of control required for the system can be selected.

5 TEMP TUPE SETTING	
5.1 WATER FLOW TEMP.	YES
5.2 ROOM TEMP.	NO
5.3 DOUBLE ZONE	NO
↕ ADJUST	↔

The unit can be managed with control of:

- **supply water temperature** T1, which has two options
 - fixed setpoint, set from the user interface
 - auto control setpoint, calculated from a preselected climate curve

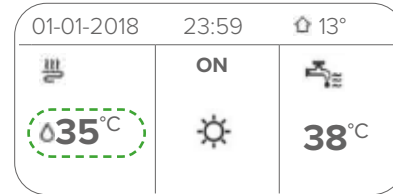

- **room temperature** T_a
In this case, the water supply set-point is automatically adjusted according to the climatic curve

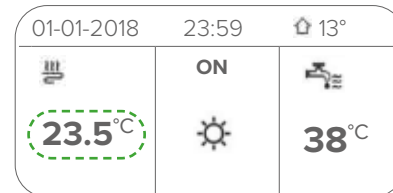

The request to the unit can be made from the user interface (thanks to the built-in temperature sensor) or from the electromechanical thermostat. In the second case, the zone thermostat can only control the Heating/Cooling mode change if it has a double relay, otherwise it must be managed by HMI.

Setting two zones

The unit can independently manage two zones, even with different temperatures.

5 TEMP TUPE SETTING	
5.1 WATER FLOW TEMP.	YES
5.2 ROOM TEMP.	NO
5.3 DOUBLE ZONE	NO
↕ ADJUST	↔

Control can be:

- of the supply water temperature for both zones.
In this case, the user can set the set-point of Zone 1 TS1 and Zone 2 TS2
- of supply water temperature for Zone 1 and of room air temperature for Zone 2 (from HMI)
In this case, the user can set the Zone 1 TS1 set-point, while the Zone 2 supply water temperature will be automatically adjusted with a climate curve

⚠ Both zones can be equipped with an electromechanical thermostat to manage the request. In double zone systems, Zone 1 cannot have room air temperature control.

System operation settings

By selecting the water supply set-point TS_1 , the heat pump can receive the request from an electromechanical thermostat installed in the room. The unit logic considers an activation hysteresis for Heating $dT1SH$ (default 5°C , can be adjusted to 2-10) and another for Cooling $dT1SC$ (default 5°C , can be adjusted to 2-10):

In Heating mode the compressor starts when $T1 < T1S - dT1SH$ and stops when $T1 \geq T1S + dT1SH$

In Cooling mode the compressor starts when $T1 > T1S + dT1SC$ and stops when $T1 \leq T1S - \Delta TC$

Note: ΔTC is a constant that cannot be changed and can either be 0 (for $5^\circ\text{C} \leq T1 < 8^\circ\text{C}$) or -1 (for $8^\circ\text{C} \leq T1$)

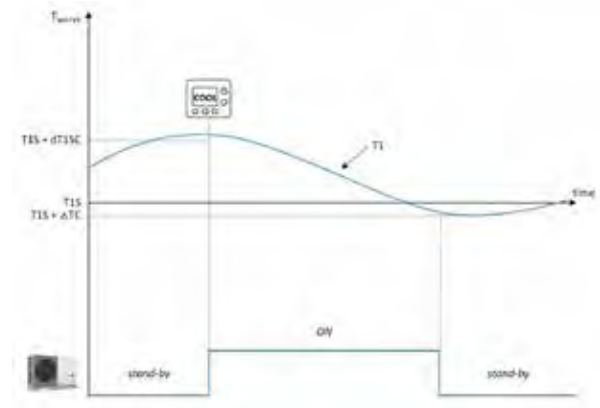
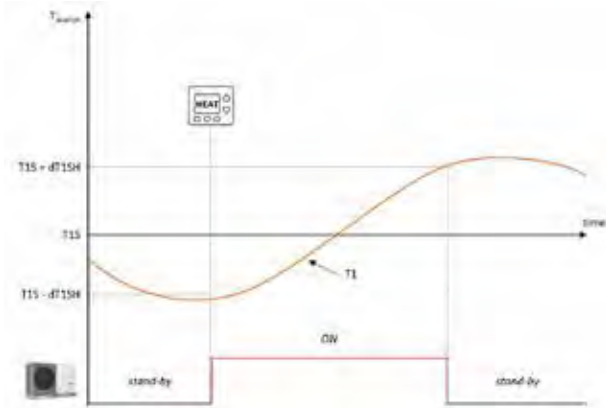

By selecting the indoor air set-point (TS), the heat pump receives the request from the user interface, which is used as a thermostat.

The unit logic considers an activation hysteresis for Heating $dTSH$ (default 2°C , can be adjusted to 1-10) and another for Cooling $dTSC$ (default 2°C , can be adjusted to 1-10):

In Heating mode the compressor starts when $Ta < TS - dTSH$ and stops when $Ta \geq TS + dTSH$

In Cooling mode the compressor starts when $Ta > TS + dTSC$ and stops when $Ta \leq TS - \Delta TC$

Note: ΔTC is a constant that cannot be changed and can either be 0 (for $5^\circ\text{C} \leq T1 < 8^\circ\text{C}$) or -1 (for $8^\circ\text{C} \leq T1$)

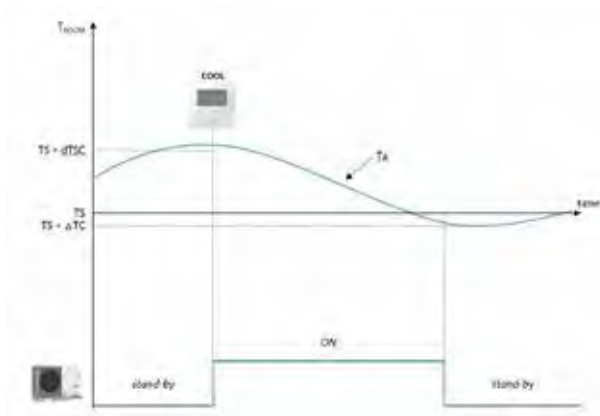
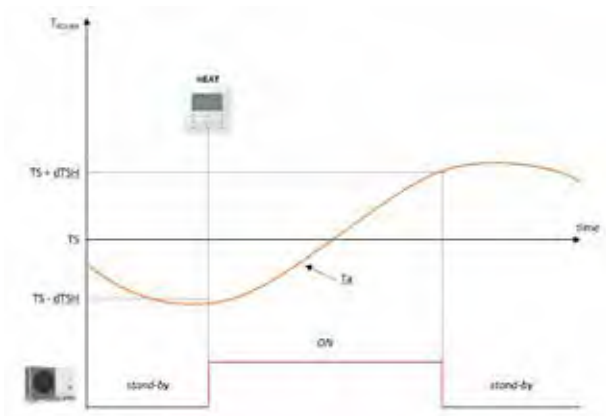

- ⚠ In both cases, the pump continues to work even after the compressor is switched off for a time set in the unit parameters
- ⚠ After it turns OFF, the compressor must wait at least 5 minutes before restarting

The heat load of a building can vary considerably throughout the year depending on factors such as outdoor air temperature, insulation, thermal inertia, crowding, etc. In heating mode, it is therefore advisable to use the water supply set-point with automatic control or the indoor air set-point (which controls the water supply with the climate curve).

In cooling mode, on the other hand, it is also necessary to dehumidify to reduce the latent refrigeration load. It is therefore advisable to run terminal distribution with the fixed set-point of the water supply.

Main functions

One of the curves designed to optimise the system can be selected at the user interface:

- 8 default curves for Heating mode on systems with radiant distribution

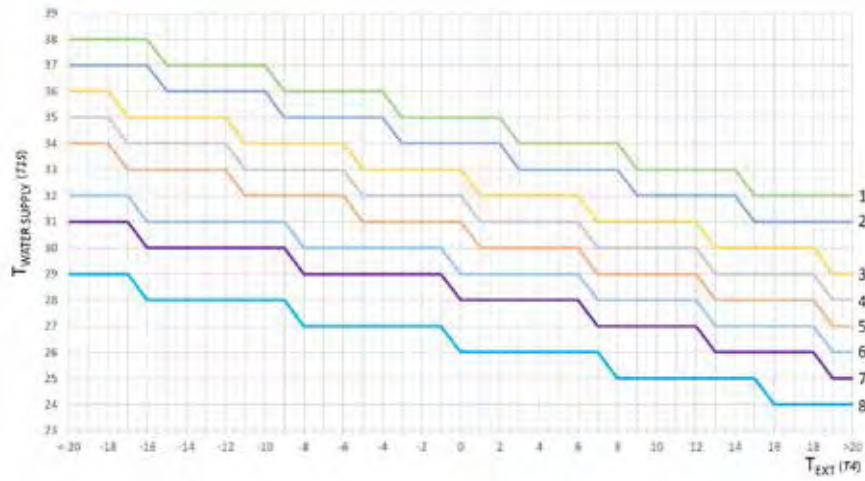

⚠ The default curve for Heating mode is 3, for ECO mode it is 6

- 8 default curves for Heating mode on systems with terminal distribution

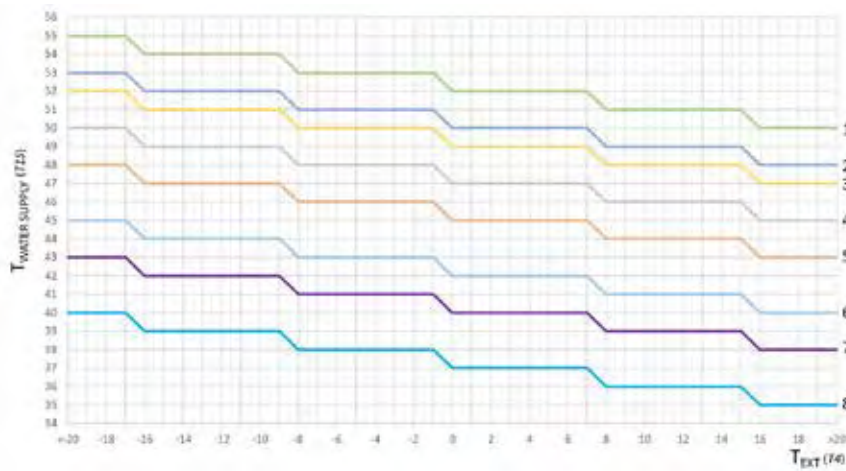

⚠ The default curve for Heating mode is 4, for ECO mode it is 6

- 1 customisable curve, using the outdoor air temperature ($T4H1$, $T4H2$) and water supply ($T1SETH1$, $T1SETH2$) parameters

WEATHER		TEMP SET	
WEATHER		TEMP SET TYPE	
1	2	3	4
5	6	7	8
OK CONFIRM		↔	

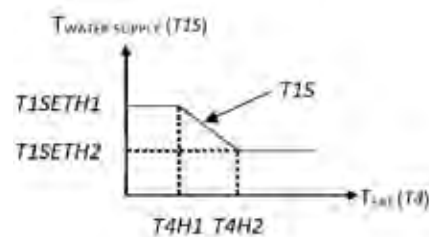

- 8 default curves for Cooling mode on systems with radiant distribution

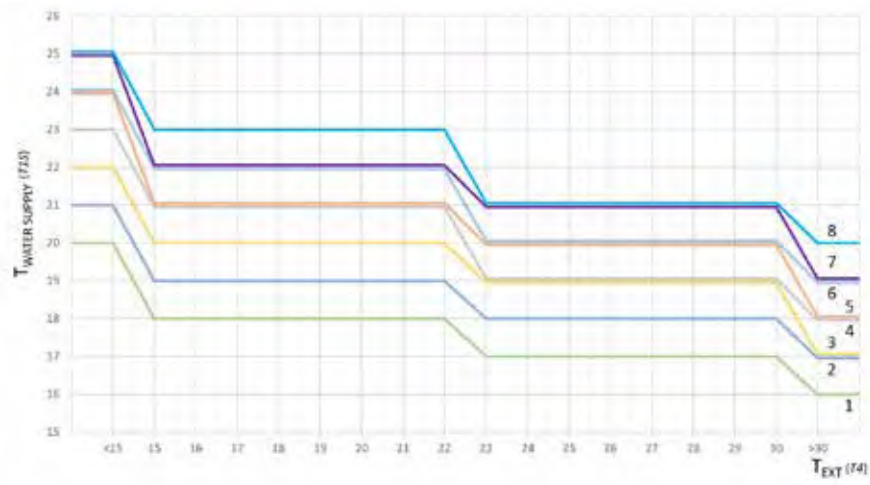

⚠ The default curve for Heating mode is 4

- 8 default curves for Cooling mode on systems with terminal distribution

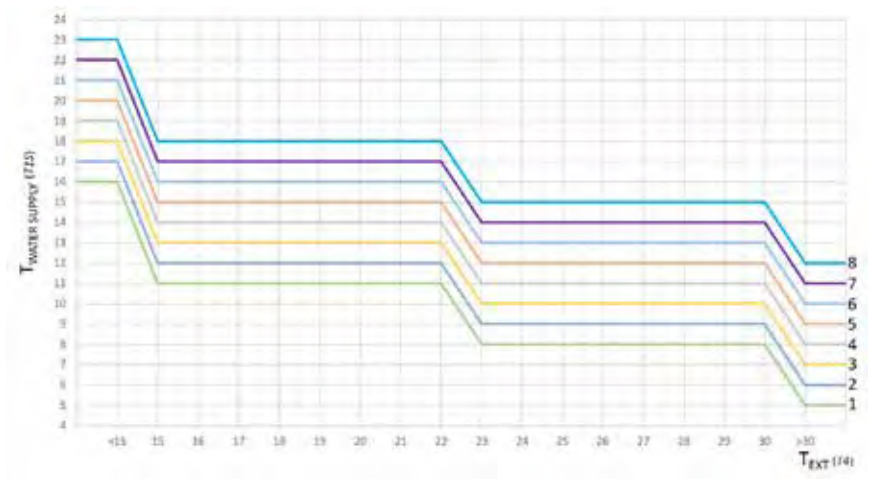

⚠ The default curve for Cooling mode is 4

- 1 customisable curve, using the outdoor air temperature ($T4C1$, $T4C2$) and water supply ($T1SETC1$, $T1SETC2$) parameters

WEATHER		TEMP SET	
WEATHER		TEMP SET TYPE	
1	2	3	4
5	6	7	8
OK CONFIRM			↔

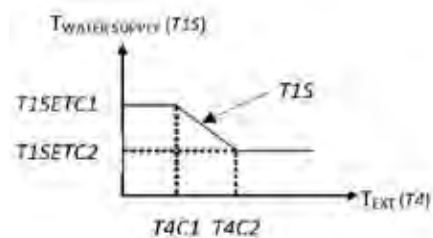

Main functions

AUTO mode

The unit can autonomously manage its own operating mode during the year, adjusting itself according to the outdoor air temperature and a series of parameters that can be set during initial start-up:

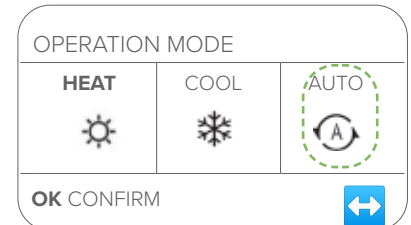
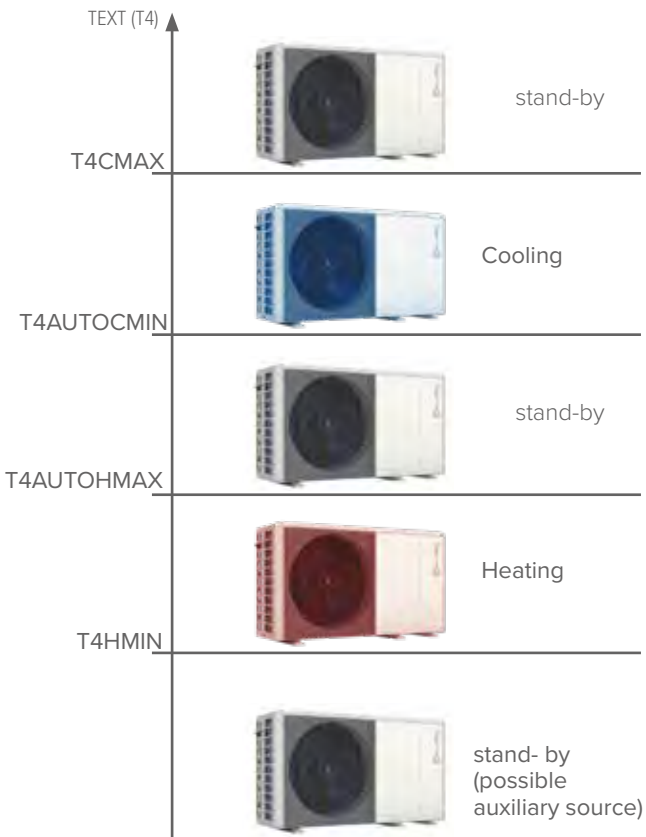

- Default values:
- T4CMAX: 52 °C
 - T4AUTOCMIN: 25 °C
 - T4AUTOHMAX: 17 °C
 - T4HMIN: -15 °C

Silent function

The Silent function can be enabled at the HMI (also with an on/off timer) and makes the unit run in one of two silent modes. It electronically limits the maximum operating frequency of the fan and compressor, thus reducing the maximum power output of the unit depending on the operating conditions.

Activation is linked to the outdoor air temperature T4 according to this logic:

Heating / DHW

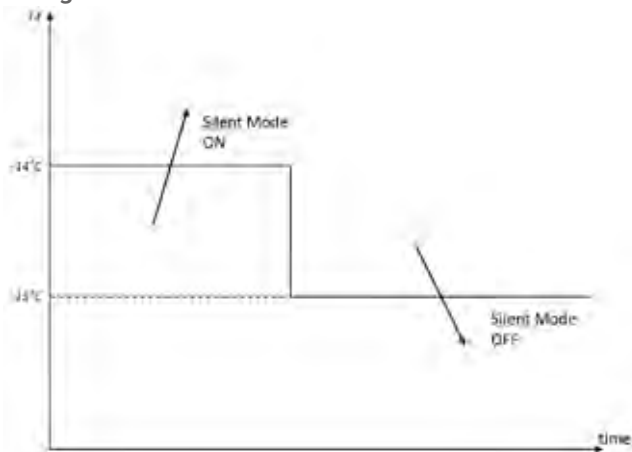

Cooling

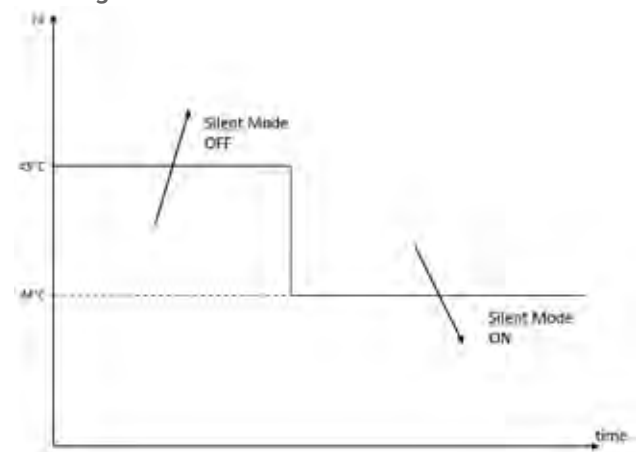

Level 1 (Silent) reduces the sound power of the unit by half on average, while level 2 (Super Silent) reduces it to 25 per cent on average.

⚠ The maximum power at limited frequency varies according to the operating conditions and can be roughly estimated using a reduction coefficient K: for Silent K = 0.8, for Super Silent K = 0.6.

Photovoltaics and the Smart Grid

The unit is Smart Grid Ready certified and is equipped with logic for connection to devices that balance loads connected to the power grid and optimise overall power consumption. Connection is optional and the function can be enabled at the HMI and is linked to the SG ON/OFF input, which receives a status signal from the mains.

The unit is also able to automatically consume the excess energy produced by a photovoltaic system, using it to store free thermal energy in the DHW tank. The function is activated at the HMI with the Smart Grid function and is linked to the EVU ON/OFF input, which receives a signal from the energy meter that indicates to the unit when excess free energy is available.

The control logic of the two contacts is

ENERGY COST	CONTACT		AVAILABLE HEATERS	SYSTEM	OPERATION	
	SG	EVU			DHW	
Free	ON	ON	-	Standard	No demand for Heating / Cooling: forced operation in DHW mode with T5S set-point = 60 °C	
			IBH		Forced DHW operation with T5S set-point = 70 °C TBH is activated as long as the DHW set-point is met <i>If necessary, the heat pump can work simultaneously with the system in Heating/Cooling mode</i>	
			TBH IBH + TBH*			
Economical	OFF	ON	-	Standard	The DHW set-point is forced to T5S + 3 °C	
			IBH		The DHW set-point is forced to T5S + 3 °C TBH is activated when T5 < T5S - 2 °C and is stopped when T5 ≥ T5s + 3 °C	
			TBH IBH + TBH*			
Standard	OFF	OFF	any	Standard	Standard	
Expensive	ON	OFF	-	Forced OFF	Forced OFF**	
			IBH / TBH			

*If IBH and TBH are enabled together, IBH can only be used with the system in heating mode

**DISINFECT, FAST DHW, TANK WATER and other DHW-related functions are disabled

⚠ Frost protection and defrosting operate smoothly in all conditions

⚠ If AHS is available, it can operate normally in heating or DHW mode in all conditions

€/Switch (for hybrid version)

The hybrid version of the unit is based on a logic of economical optimisation of the various heat sources available: while the efficiency of the boiler is a constant value, that of the heat pump is dependent on the outdoor air temperature and the water supply temperature.

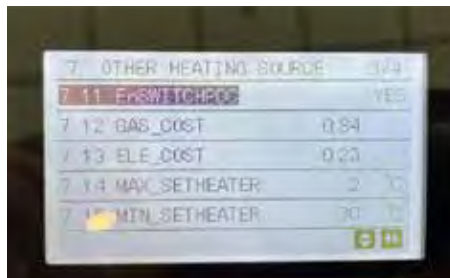

The function has to be activated at the HMI (parameter EnSWITCHPDC) and compares the economic expenditure in the operating conditions with the Heat Pump or Back-up Boiler, giving it priority. It does this by using values which can be easily found in household supply bills and can be entered by the HMI at start-up:

- average cost of gas feeding the boiler, expressed in €/m³ (GAS_COST, default 0.85€/m³, can be adjusted)
- average cost of electricity, expressed in €/kWh (ELE_COST, default 0.2€/kWh, can be adjusted).

Based on these values, the unit calculates the minimum operating efficiency where it is economically viable to operate the heat pump alone. When the unit detects operation with instantaneous efficiency below this value, it makes the boiler alone meet the load.

⚠ Possible operation of the boiler in integration with the heat pump remains unchanged

Main functions

Other functions for the installer

- ✓ **Service call:** stores up to 2 telephone contacts to be displayed in case of need
- ✓ **Restore factory settings:** resets all HMI parameters to factory settings
- ✓ **Underfloor pre-heating:** in the case of systems with a radiant floor that have been idle for some time, perform a slow start-up cycle of the unit to avoid damaging it. You can set t_{fristFH} duration (*default 72h, can be adjusted*) and final water set-point TS1 (*default 30 °C, can be adjusted*) of the cycle
- ✓ **Remote ON/OFF contact:** dry contact that can be enabled at the HMI to work as an ON/OFF input. When the contact is open the unit operates normally, when it is closed the unit switches off and an identification code appears on the display.
⚠ *The unit's antifreeze protections remain active*
- ✓ **Floor drying:** in the case of new systems with radiant floors, perform a drying cycle of the unit to avoid damaging it. The cycle includes a phase of gradual rise in temperature, a holding phase and a phase of gradual shutdown.
You can set the duration of all phases (*respectively t_{DRYUP} , default 8 days / t_{DRYPEAK} , default 5 days/ t_{DRYD} , default 5 days*) and the peak water temperature (T_{DRYPEAK} , *default 45 °C, can be adjusted*).
- ✓ **Automatic restart:** sets whether the unit, after a power failure, should automatically restart with the last settings or remain in stand-by mode.
- ✓ **Power input limitation:** sets a parameter 0-8 that limits the maximum current absorbed by the unit (see dedicated section for further details)
- ✓ **Error codes and parameters:** displays the list of the last 8 error codes and operating parameters
- ✓ **Defrost or alarm status signal:** allows this information to be controlled remotely

Other functions for the user

- ✓ **Default temperatures:** sets a daily profile of up to 6 water supply temperatures for Heating or Cooling, which can be used as an alternative to selecting a climate curve
⚠ *in the case of 2-zone systems, the default temperatures operate only in zone 1*
- ✓ **ECO function:** sets an energy-saving climate curve in Heating mode for setting the water supply set-point. The curve set by the ECO mode for radiant distribution systems is number 3, while for terminal distribution systems it is number 6.
⚠ *the function is not available with 2-zone systems*
- ✓ **Weekly scheduling (hourly programming):** sets the unit's weekly schedule of up to 6 time slots with different modes and set-points
- ✓ **Holiday Away function:** prevents the system from freezing during prolonged periods of absence and activates the system before the user returns home.
- ✓ **Holiday at home function:** sets a weekly schedule for a period of time without eliminating the standard one.
- ✓ **Child lock:** prevents accidental changes to settings by blocking selection of the set-point and mode

Management of auxiliary heat sources

The unit has electronics designed for integration with other heat sources to ensure performance even in the most difficult conditions and to maximise efficiency of the system.

The auxiliary heat sources are managed by the unit as dry contacts and can be:

- Additional electric heater for DHW boiler (TBH), for DHW contribution only
- Solar thermal circuit, for DHW contribution only
- Auxiliary heat source: Additional electric heater (IBH) or external generator (AHS), e.g. a boiler from another supplier, for system and/or DHW contribution

⚠ Only IBH or AHS can be managed at the same time.

The additional electric heater or the external generator can operate as:

- Integration: when it is not convenient/possible to work with the heat pump capacity alone
- Replacement: outside the work settings of the heat pump
- Back-up: in case of failure in the unit's refrigeration circuit (the unit keeps the pump running at maximum speed)

Management of an additional electric heater for DHW boiler

The electric heater of the TBH boiler is activated below the outdoor air temperature $T4_TBH_ON$ (default 5 °C, can be adjusted to between -5 and 50)

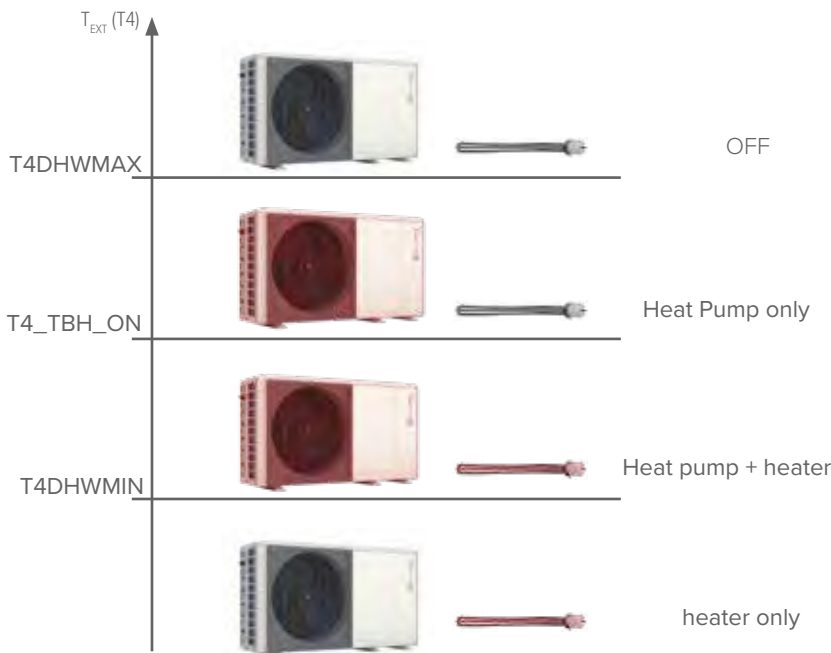

Other parameters related to TBH management are the maximum time of DHW production in heat pump mode only without reaching the set-point before activating TBH t_TBH_DELAY (default 30min, can be adjusted to 0-240) and the temperature delta beyond the set-point to which the heater can bring the boiler $dt5_TBH_OFF$ (default 5 °C, can be adjusted to 0-10). The logic is:

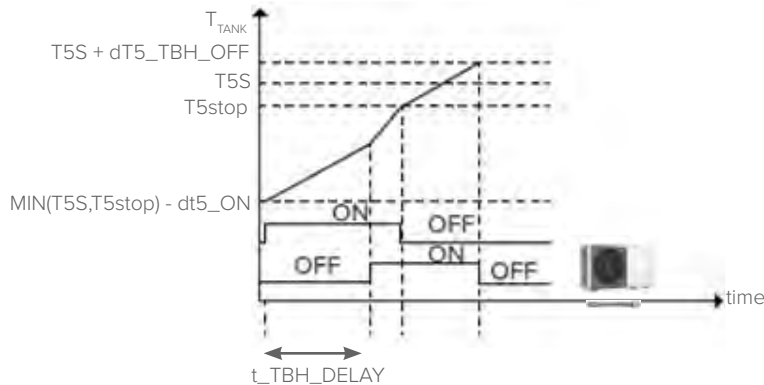

Other functions related to the TBH heater are:

- RAPID DHW: forces DHW production with heat pump and TBH heater up to set-point
- TANK HEATING: the unit produces DHW with the TBH heater in the event of simultaneous demand for DHW and system (continuing to work as a heat pump in the system) and in the event of a failure.

DOMESTIC HOT WATER (DHW)			
DIS-INFECT	FAST DHW	TANK HEATER	DHW PUMP
CURRENT STATE			ON
OPERATE DAY		FRI	
START		23:00	
ON/OFF		↕ ↔	

Management of auxiliary heat sources

Connection to a solar thermal circuit

The solar thermal panels must be hydraulically connected to appropriate double-coil DHW boilers via a circuit with a dedicated P_s pump (from ELFOSun or other supply, with consent provided by the unit).

The solar system is set at the HMI, where it is possible to select between two types of control:

- DHW from both solar panels and heat pump: when there is a demand for DHW, the heat pump (and any other auxiliary sources) works normally, and the solar system can work alongside it, activating itself according to the unit's logic.
- DHW from solar panels only: heat pump and any other auxiliary sources cannot work in DHW mode, remaining available for the system. DHW is managed with only production from the solar system, which is activated according to the unit's logic.

⚠ The Smart Grid function can still activate the heat pump and any auxiliary sources. TBH can be forced with the relevant function.

In both cases when there is a demand for DHW, the solar panels are managed by the unit that activates the pump P_s. This is based on the value detected by the T_{solar} temperature probe and the setting of the DELTATSOL parameter (default 10 °C, can be adjusted). DELTATSOL is the ΔT between the temperature of the water in the solar circuit T_{solar} and the temperature of the DHW boiler T₅ above which the pump P_s is activated.

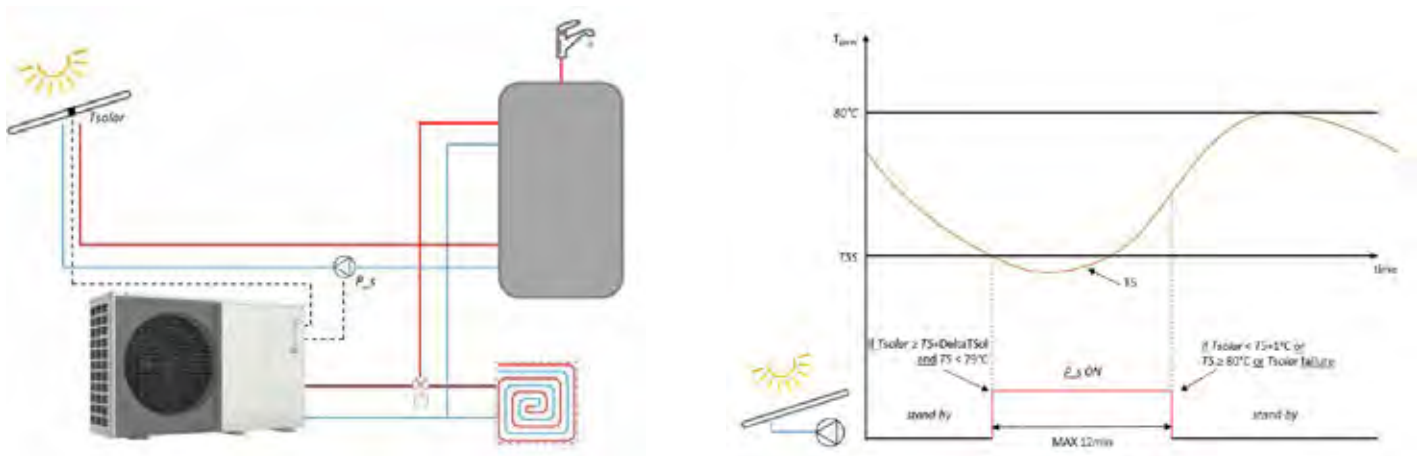

Alternatively, management of the pump can be delegated to the ELFOSun intelligent control unit (see the dedicated Technical Bulletin for further details). In this case, it is not necessary to make any settings on the unit, as management is set directly on ELFOSun.

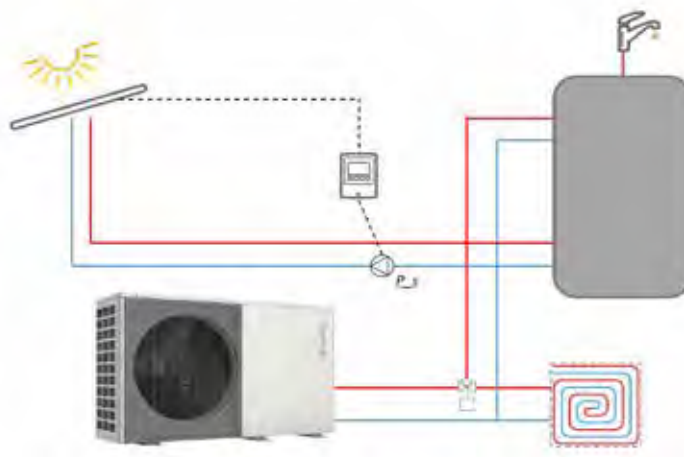

Management of auxiliary heat sources

Auxiliary heat source

Where applicable, the heater must be positioned on the unit's water supply and can be factory-fitted on board (IBH configuration) or may require external installation (IBHX / IBHTX accessory). In both cases, its operation is linked to a dedicated T1 temperature probe to be positioned downstream of the heater.

Configuration



Accessory

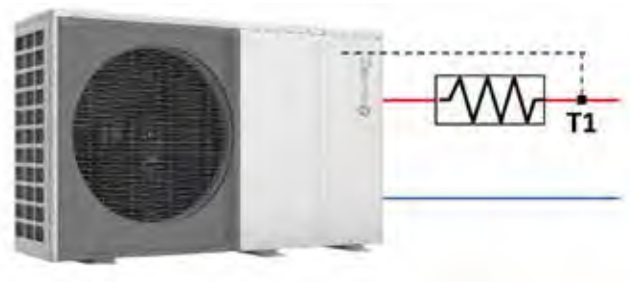

Note: the T1 probe is included in the Clivet configuration and accessories and does not need to be selected separately

A boiler, if any, must be installed in parallel with the heat pump and can act:

- on the system and DHW: installed directly on the system, in this case its operation will require a dedicated T1 temperature probe to be installed downstream.

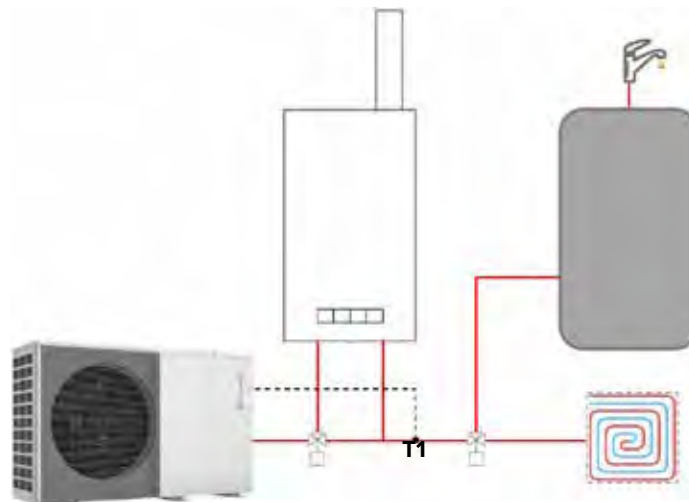

- only on the system: installed on a hydraulic separator, where the T1 probe must also be fitted



The boiler's activation operating mode (in Heating, DHW production or both) must be selected with the dip-switches on the board during installation.

⚠ Caution: during operation in cooling mode of systems with boilers for centralised systems or heater, it is important not to circulate cold water in the boiler/heater, as there is a risk of condensation forming. It is advisable to install a thermostatic switching valve or a 3-way or 2-way valve controlled by a back-up relay on the boiler/heater branch.

Note: boilers for stand-alone systems do not need this safety feature as they are already equipped with a bypass valve

Management of auxiliary heat sources

Activation of the auxiliary source is linked to the simultaneous presence of 3 conditions, each of which is associated with a parameter that can be adjusted during initial start-up on the user interface:

- very low outdoor temperature
parameter $T4_IBH_ON$ or $T4_AHS_ON$ (default $-5\text{ }^{\circ}\text{C}$, can be adjusted to between -15 and 30): the minimum outdoor air temperature for heat pump operation only

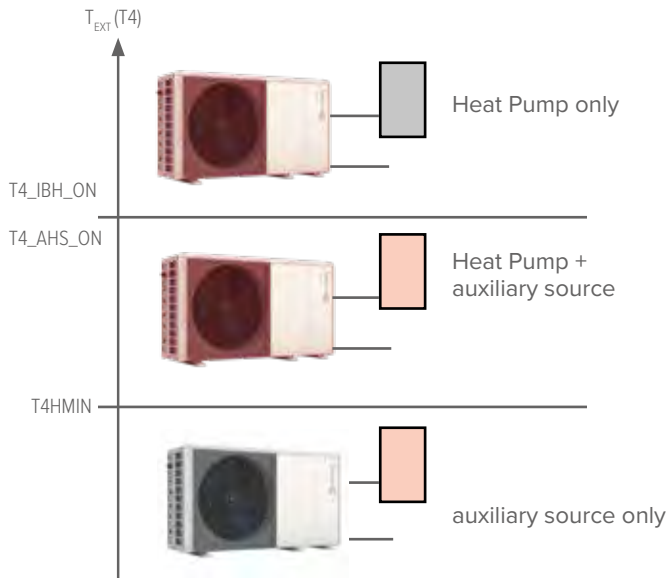

⚠ To make the auxiliary source work only in replacement of the unit, set the parameter to the same value as $T4HMIN$ (default $-15\text{ }^{\circ}\text{C}$, can be adjusted to between -25 and 15): the minimum outdoor air temperature at which the heat pump can operate.

- supply temperature too far from the set-point
parameter $dt1_IBH_ON$ or $dt1_AHS_ON$ (default $5\text{ }^{\circ}\text{C}$, can be adjusted to $2-10$): the minimum ΔT between water set-point $TS1$ and supply of the unit $T1$
- too long to reach the set-point
parameter t_IBH_DELAY or t_AHS_DELAY (default 30min , can be adjusted to $5-120$): the maximum delay between starting of the compressor and activation of the auxiliary source

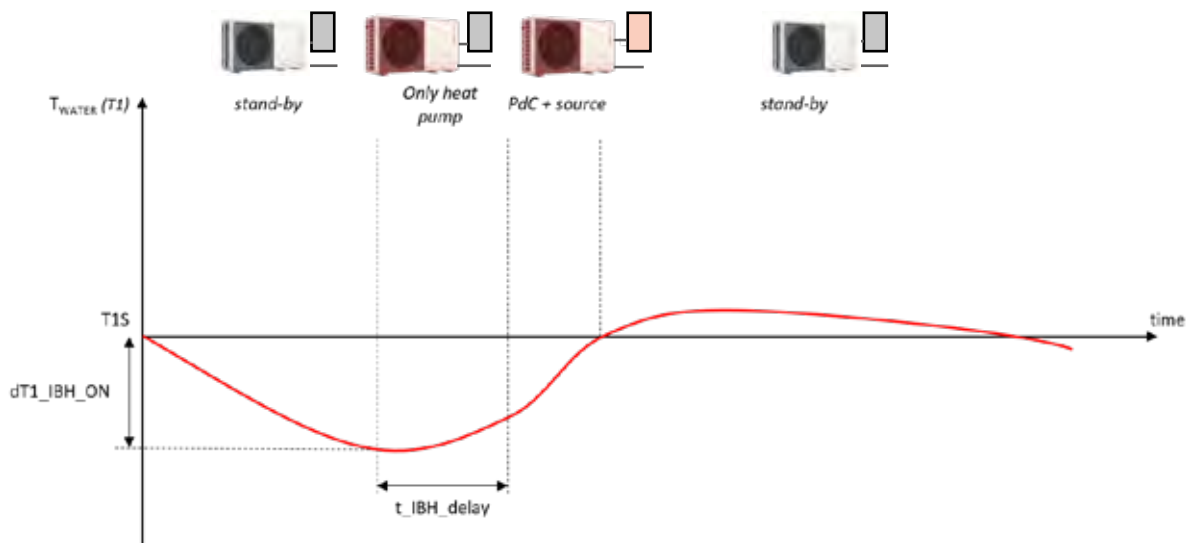

⚠ The BACKUP HEATER function on the HMI allows activation of the IBH or AHS auxiliary source to be forced

The unit can manage the DHW set-point dynamically with a 0-10V signal, using the parameters:

- $MAX_SETHEATER$ (default: $80\text{ }^{\circ}\text{C}$, adjustable) and $MIN_SETHEATER$ (default: $30\text{ }^{\circ}\text{C}$, adjustable): the maximum and minimum set-point of the boiler
- $MAX_SIGHEATER$ (default: 10V , adjustable) and $MIN_SIGHEATER$ (default: 3V , adjustable): 0-10V signals linked to the maximum and minimum set-point of the boiler

Management of units in cascade

Many applications require units to be installed as back-up for the main system or have loads that can change significantly during annual operation. Cascade operation allows connection of up to 6 units in parallel, running a Master unit and activating the Slave units when its own capacity is not sufficient to meet the load of the system, ensuring maximum reliability and efficiency of the system.

The system rotates operation of all of the units by counting the compressor's operating hours, so as to use them evenly. In the event of failure of a unit, including the Master, the system ensures continuity of service.

Cascade management is provided as standard by the logic of the units; it must be set with the dip-switches (Master or Slave unit) on the board and all Slave units must be connected with a serial to the HMI of the Master. The slave units are automatically addressed by the Master at start-up.

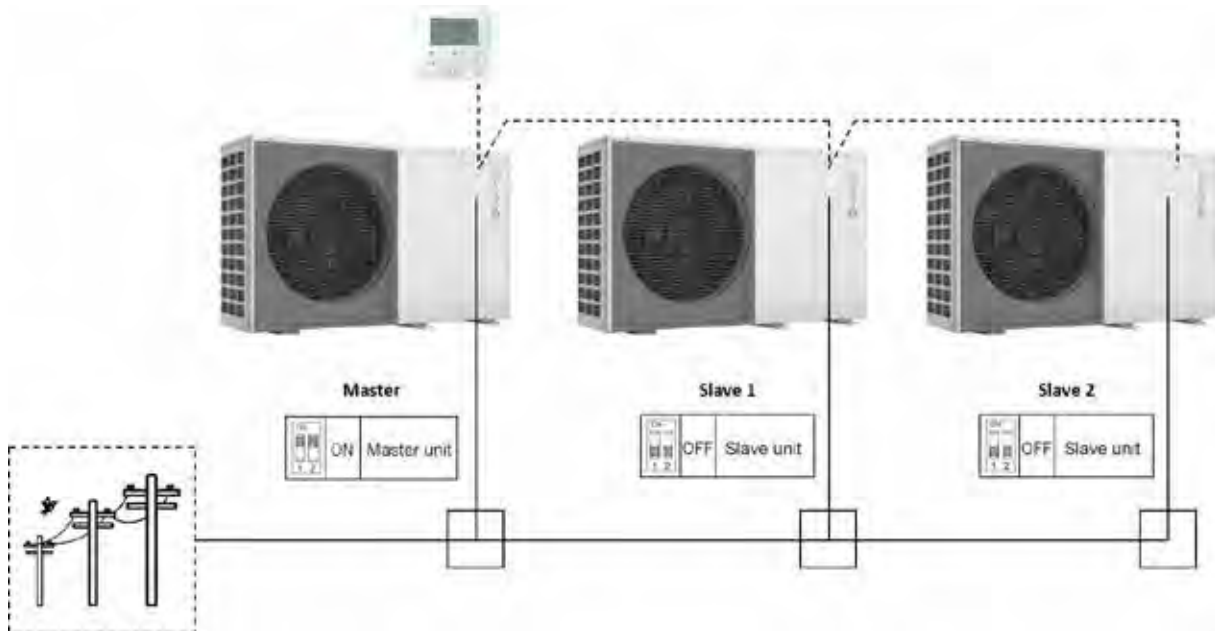

The Master unit is the only one that can:

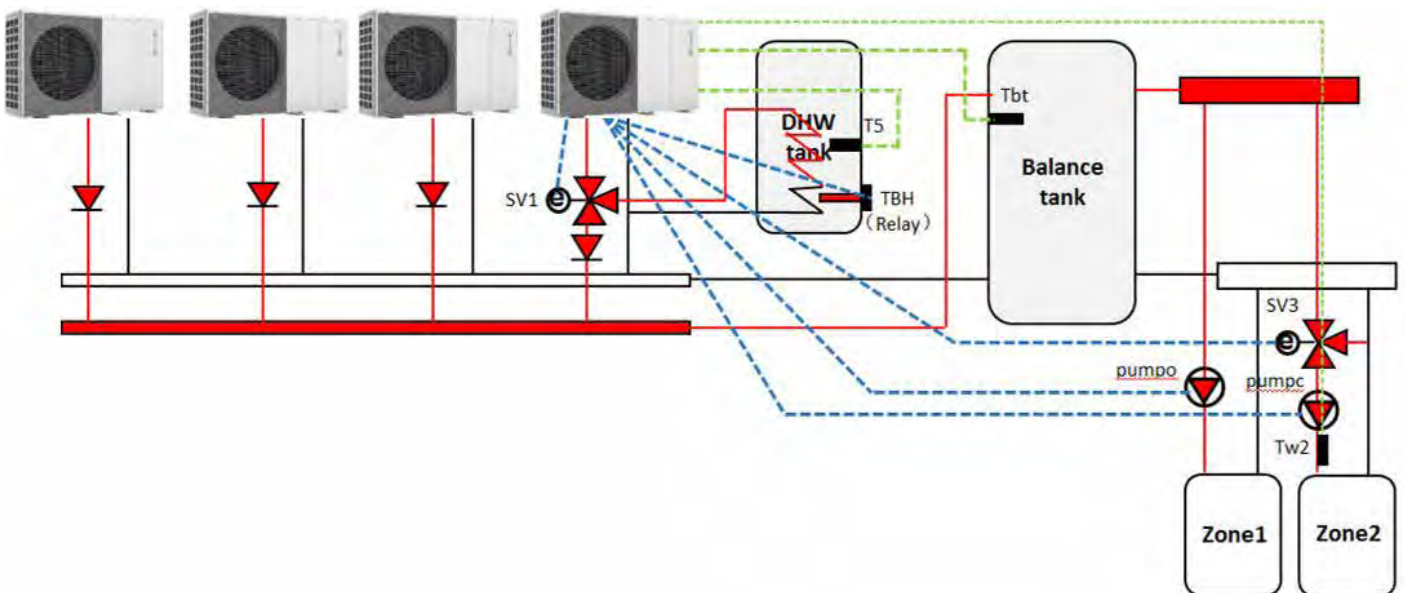

- receive signals (in green in the figure) from the optionally installed temperature probes: T5 of the DHW tank, Tbt1 of the hydraulic separator, Tsolar of the solar system and Tw2 of the supply of the mixed circuit
- manage the components of the system (in blue in the figure): SV1 3-way switching valve, heater of the TBH DHW tank, SV2 3-way switching valve for direct 2-zone systems or SV3 mixed circuit, P_o secondary circuit pump, P_c mixed circuit pump, P_s solar pump, P_d DHW recirculation pump and AHS auxiliary source
- receive external inputs: external ON/OFF signal via potential-free contact, signal from zone thermostat, Smart Grid signal and solar signal

Note: each unit manages its own IBH additional electric heater, if present

App management via Wi-Fi

The unit has standard control and management with App via a device located inside the HMI, which provides the following functionality:



MSmart Home



✓ Change the main settings of the unit remotely

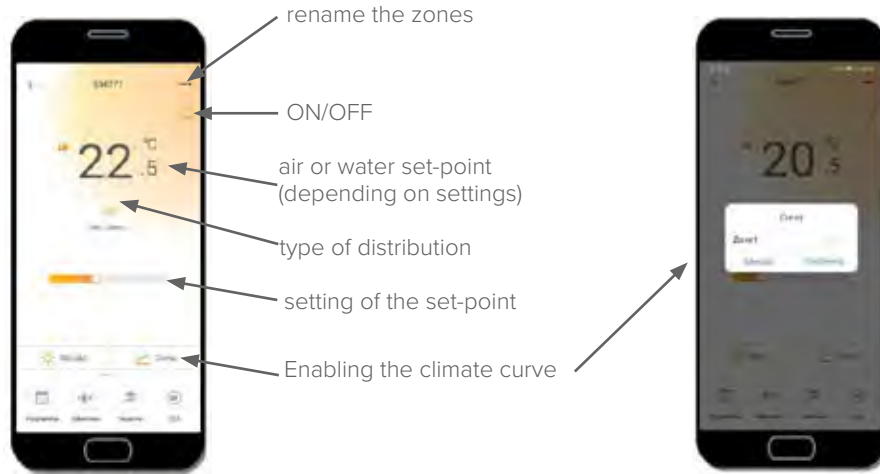

✓ ON/OFF and change of operating mode



✓ Setting and management of DHW

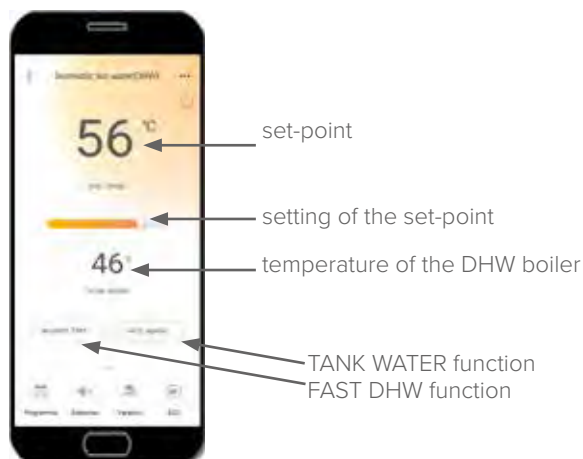

Connectivity

✓ Management of systems with two zones

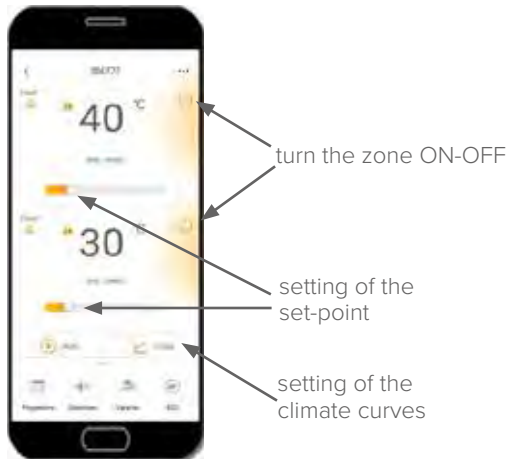

✓ Error Display



✓ Daily and weekly scheduling

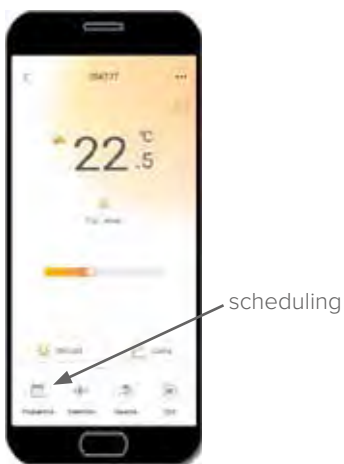

✓ ECO function

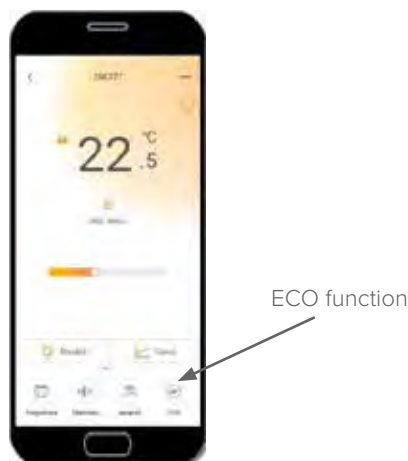

✓ Silent function



silent function



selection of level of Silent mode

Silent mode ON/OFF timer

✓ Holiday function



Holiday function



• Holiday Away
• Holiday at home



start/end Holiday mode

The App is available in these languages: English / Italian / German / French / Spanish / Finnish / Dutch / Polish / Romanian / Russian / Turkish / Ukrainian / Portuguese

Note: information and screenshots are for illustrative purposes only as the App may have a different appearance or functions.

Connectivity

Management via ELFOControl

ELFOControl is a home automation system with an intuitive and user-friendly touch screen panel that allows management of the air conditioning system and electricity in the home, optimising efficiency and comfort.

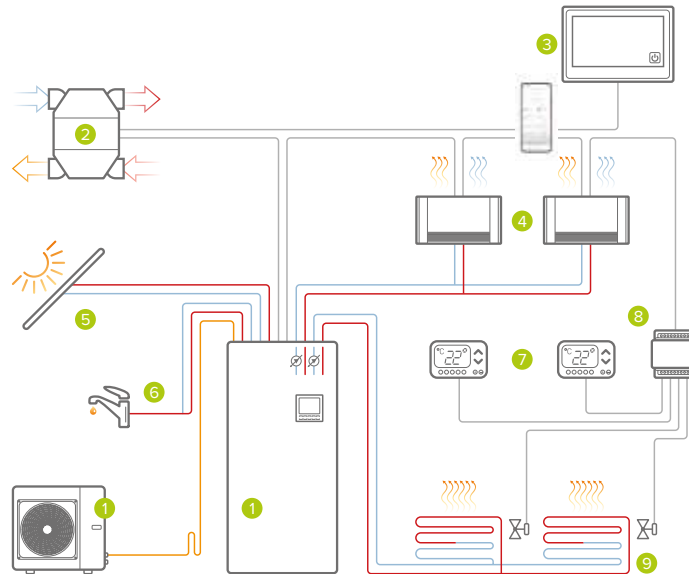

- manages all the main components of a system with up to 12 zones: the heat pump, up to 4 mechanical ventilation units, distribution with up to 40 elements including radiators, radiant heaters, terminal units or pumps
- measures, analyses and manages the energy of the photovoltaic solar park (*accessory required*)
- performs diagnostics on all connected compatible Clivet devices
- optimises the devices of the system according to external conditions and comfort conditions
- can be managed from a PC, smartphone or tablet with the Clivet EYE App (*accessory required*)

ELFOControl



MIOTX accessory

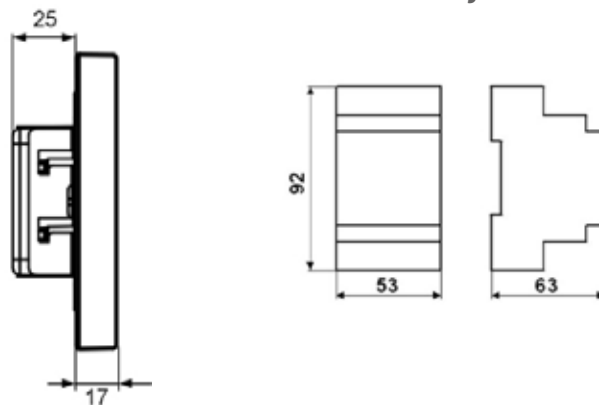

Display	7" TFT colour
Power supply	12 Vdc
Power	10W
Protection rating	IP20
Weight	0.5 kg

Monitoring and management via Clivet EYE

Clivet EYE is a Cloud-based monitoring and remote management system for Clivet units and systems that allows supervision via App or Web Dashboard.

It is a useful tool that optimises the relationship between the user and technical support, which in this way can:

- Analyse operation and performance of the system remotely, in order to minimise the need for visits to the site
- Plan and optimise maintenance work and assistance
- Reset minor alarms remotely (*function not compatible with Edge units*)

Management via Modbus

The user interface has an RS485 port for communication between the heat pump and BMS and Home Automation systems via Modbus RTU protocol: up to 16 units can be connected.

The user interface acts as a slave, allowing the main operating variables, statuses and alarms of the heat pump to be read and all the main functions to be set.

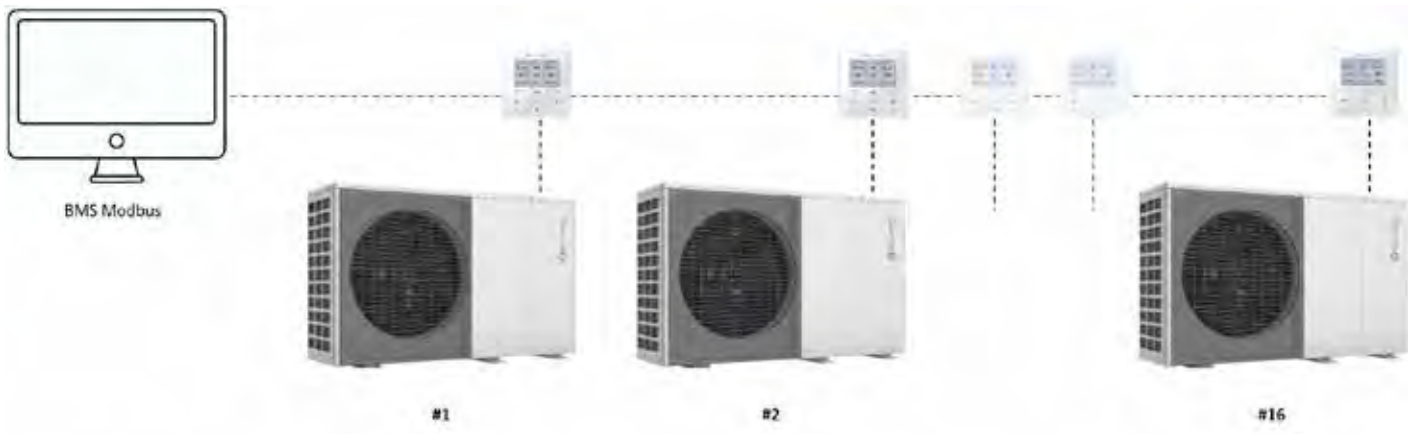

Note: refer to the relevant information in the manual

Electrical connections

The unit can be accessed for the purpose of making connections by removing the front panel. The unit has an internal control board and a dedicated board for management of the system:

Sizes 2.1 to 8.1

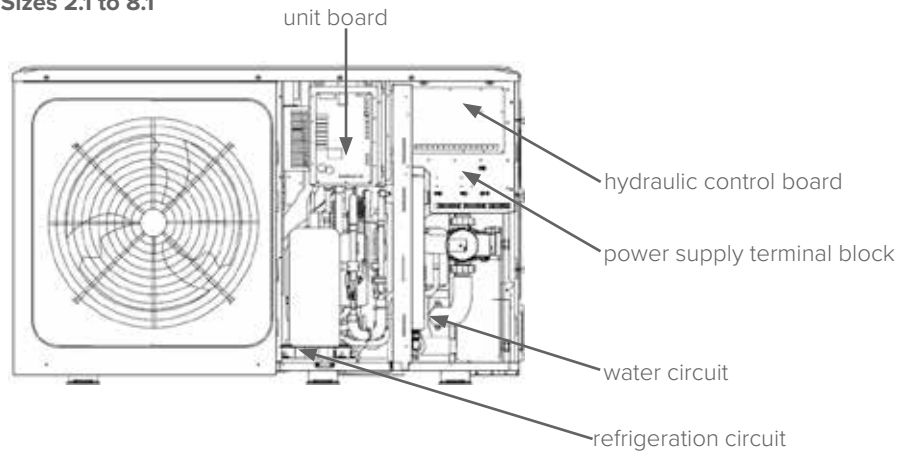

Sizes 9.1 to 14.1

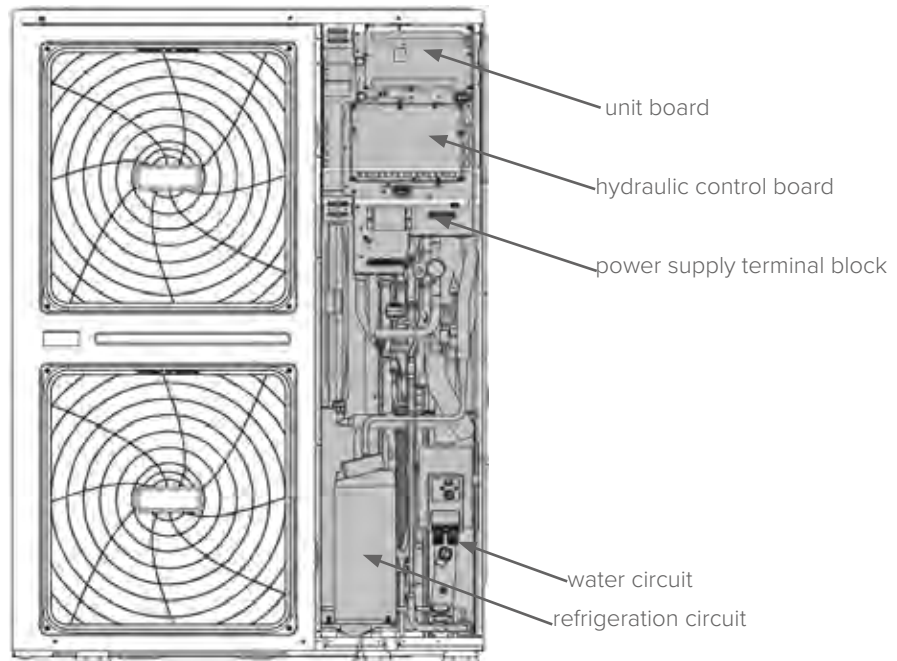

Wiring the power supply

The power supply must be connected to the power supply terminal block, with dedicated fuses or circuit breaker protections.

Connection of single-phase versions

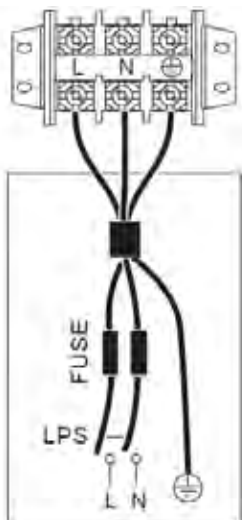

Connection of three-phase versions

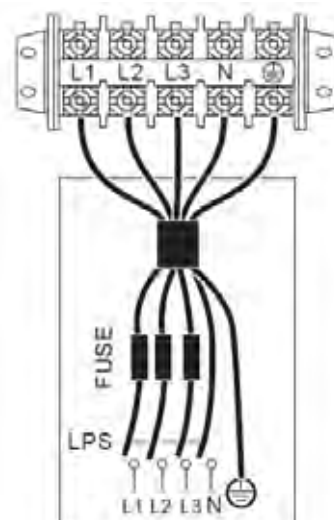

Connection of external elements

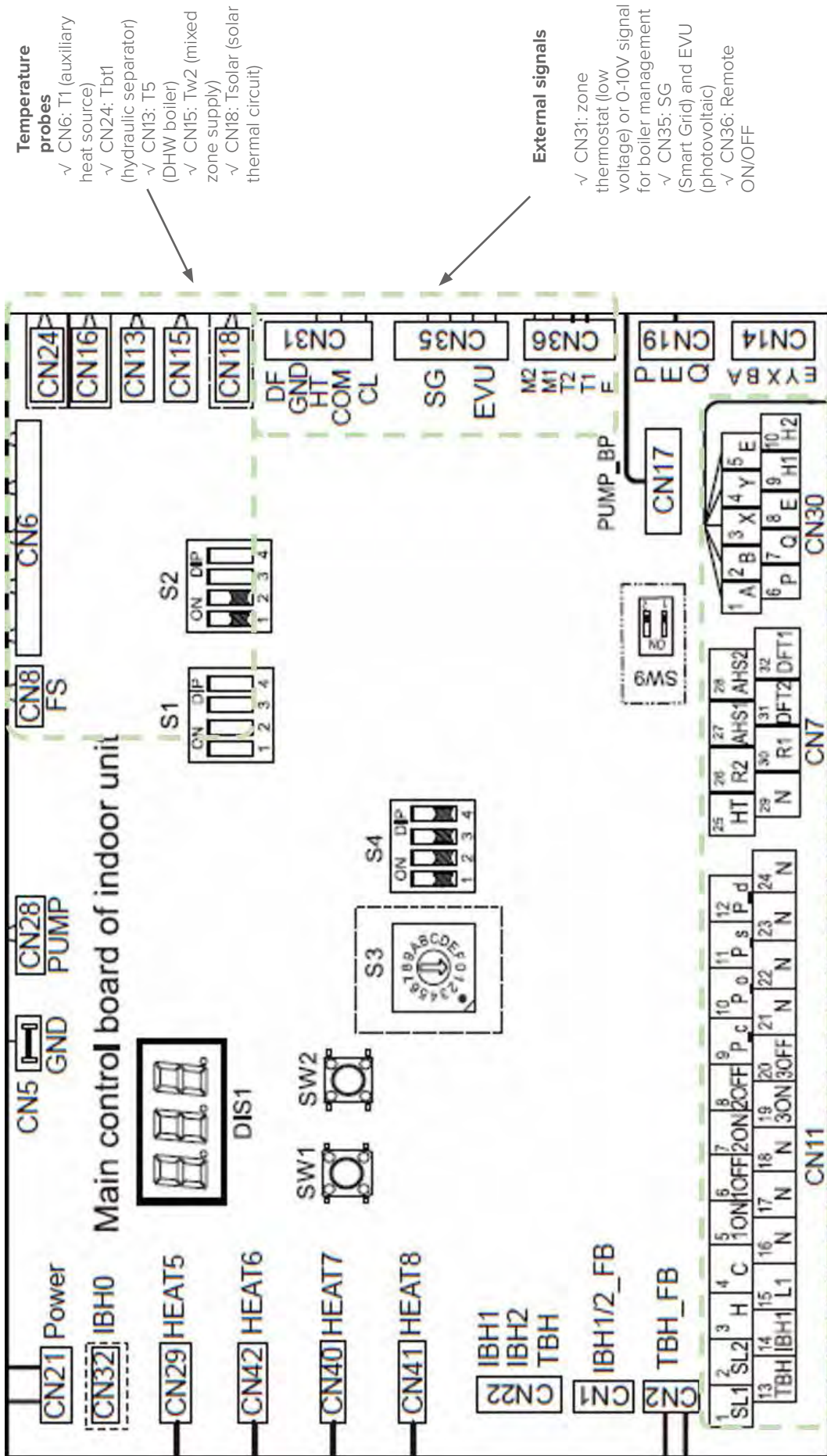

Temperature probes

- ✓ CN6: T1 (auxiliary heat source)
- ✓ CN24: Tbt1 (hydraulic separator)
- ✓ CN13: T5 (DHW boiler)
- ✓ CN15: Tw2 (mixed zone supply)
- ✓ CN18: Tsolar (solar thermal circuit)

External signals

- ✓ CN31: zone thermostat (low voltage) or 0-10V signal for boiler management
- ✓ CN35: SG (Smart Grid) and EVU (photovoltaic)
- ✓ CN36: Remote ON/OFF

External devices

- CN11**
 - ✓ 1-2 (230V): SL1/SL2 input from solar thermal controller
 - ✓ 3-4-15 (230V): zone thermostat
 - ✓ 5-6-16 (230V): SV1 (3-way valve system / DHW)
 - ✓ 7-8-17 (230V): SV2 (2-way valve for zone 2)
 - ✓ 7-17-19 (230V): 3-way valve for mixed zone 2
 - ✓ 10-22 (230V): P_o (pump for secondary circuit or Zone 1)

- ✓ 9-21 (230V): P_c (Zone 2 pump)
- ✓ 11-23 (230V): P_s (solar circuit pump)
- ✓ 12-24 (230V): P_d (DHW recirculation pump)
- ✓ 13-16: TBH (DHW boiler back-up heater)
- ✓ 14-17: IBH (external back-up heater)

CN7

- ✓ 25-29: antifreeze heater for pipes
- ✓ 26-30: operating status

- ✓ 31-32: defrosting status / alarm status (settable)
- ✓ 27-28: AHS (back-up boiler)
- ✓ **CN30**
 - ✓ 1-2-3-4-5: HMI
 - ✓ 9-10: cascade connection

Performance in heating

Sizes	Tae (°C) DB/WB	Water supply temperature (°C)														
		35			45			55			60			65		
		°C	kWt	kWe	COP	kWt	kWe	COP	kWt	kWe	COP	kWt	kWe	COP	kWt	kWe
2.1	-25/-	1.71	1.32	1.29	1.37	1.25	1.10	-	-	-	-	-	-	-	-	-
	-20/-20.1	2.44	1.70	1.43	1.98	1.75	1.13	1.56	1.59	0.98	-	-	-	-	-	-
	-15/-15.3	3.25	1.36	2.39	2.50	1.60	1.56	1.84	1.56	1.18	1.73	1.68	1.03	-	-	-
	-10/-11	4.34	1.52	2.85	3.59	1.77	2.02	2.63	1.68	1.56	2.81	1.80	1.56	-	-	-
	-7/-8	4.99	1.60	3.11	4.54	1.98	2.29	4.28	2.34	1.83	3.56	1.94	1.84	-	-	-
	-5/-6	5.02	1.53	3.27	4.63	1.89	2.45	4.41	2.26	1.95	3.83	2.00	1.92	-	-	-
	-2/-3	5.07	1.43	3.55	4.88	1.80	2.71	4.84	2.20	2.20	4.17	2.06	2.02	-	-	-
	0/-1	5.10	1.36	3.74	5.04	1.74	2.89	5.13	2.16	2.37	4.40	2.10	2.09	-	-	-
	2/1	5.33	1.34	3.98	5.26	1.73	3.04	5.29	2.12	2.49	4.60	2.10	2.19	-	-	-
	7/6	6.26	1.26	4.96	5.96	1.63	3.67	5.74	1.90	3.03	5.41	2.08	2.61	4.27	2.09	2.04
	15/12	5.75	1.25	4.59	6.20	1.47	4.21	5.63	1.65	3.41	5.04	1.76	2.87	4.87	1.90	2.56
	20/15	5.67	1.11	5.13	6.12	1.31	4.66	5.52	1.50	3.68	4.77	1.56	3.06	-	-	-
35/24	5.97	0.82	7.27	5.99	0.99	6.05	5.61	1.22	4.62	-	-	-	-	-	-	
3.1	-25/-	2.14	1.67	1.28	1.71	1.57	1.09	-	-	-	-	-	-	-	-	-
	-20/-20.1	2.88	2.03	1.42	2.33	2.08	1.12	1.84	1.86	0.99	-	-	-	-	-	-
	-15/-15.3	4.00	1.71	2.34	3.08	2.01	1.53	2.26	1.88	1.20	2.13	2.02	1.05	-	-	-
	-10/-11	5.11	1.99	2.57	4.64	2.24	2.07	3.80	2.24	1.69	3.32	2.30	1.44	-	-	-
	-7/-8	6.21	2.17	2.86	5.57	2.38	2.35	5.22	2.66	1.96	4.57	2.61	1.75	-	-	-
	-5/-6	6.14	1.99	3.09	5.84	2.30	2.54	5.31	2.64	2.01	4.73	2.59	1.83	-	-	-
	-2/-3	6.27	1.80	3.51	6.45	2.27	2.84	5.38	2.61	2.06	4.93	2.56	1.93	-	-	-
	0/-1	6.35	1.68	3.79	6.85	2.25	3.04	5.42	2.59	2.09	5.06	2.54	1.99	-	-	-
	2/1	6.56	1.66	3.97	6.91	2.20	3.14	5.70	2.54	2.25	5.33	2.54	2.10	-	-	-
	7/6	7.41	1.56	4.76	7.13	2.00	3.58	6.90	2.37	2.91	6.42	2.52	2.55	5.25	2.60	2.02
	15/12	7.26	1.38	5.28	7.63	1.83	4.16	6.98	2.12	3.30	6.01	2.23	2.70	6.10	2.39	2.56
	20/15	6.98	1.18	5.91	7.42	1.68	4.42	6.81	1.89	3.60	5.98	1.95	3.06	-	-	-
35/24	6.96	0.85	8.17	6.89	1.27	5.42	6.57	1.48	4.45	-	-	-	-	-	-	
4.1	-25/-	3.59	2.19	1.64	2.81	2.17	1.30	-	-	-	-	-	-	-	-	-
	-20/-20.1	4.74	2.24	2.11	3.70	2.29	1.61	2.62	2.10	1.25	-	-	-	-	-	-
	-15/-15.3	6.11	2.51	2.43	5.29	2.65	2.00	4.94	2.92	1.69	3.99	2.84	1.41	-	-	-
	-10/-11	7.08	2.25	3.15	6.77	2.74	2.47	6.07	3.05	1.99	5.19	2.86	1.81	-	-	-
	-7/-8	7.27	2.26	3.21	6.94	2.76	2.52	6.22	3.07	2.03	5.32	2.88	1.85	-	-	-
	-5/-6	7.69	2.39	3.22	7.44	2.77	2.69	6.45	2.94	2.19	6.04	3.00	2.02	-	-	-
	-2/-3	8.17	2.31	3.55	7.83	2.76	2.84	6.84	2.97	2.30	6.53	3.10	2.11	-	-	-
	0/-1	8.49	2.25	3.77	8.09	2.75	2.94	7.10	2.99	2.38	6.85	3.16	2.17	-	-	-
	2/1	8.71	2.14	4.09	8.33	2.68	3.12	7.28	2.89	2.53	6.95	3.05	2.29	-	-	-
	7/6	9.11	1.80	5.07	8.98	2.35	3.82	7.80	2.50	3.12	7.24	2.66	2.72	4.08	3.00	1.36
	15/12	9.09	1.51	6.04	8.91	2.03	4.38	8.32	2.34	3.55	7.68	2.49	3.09	5.71	2.39	2.39
	20/15	9.33	1.32	7.09	9.08	1.81	5.02	8.43	2.12	3.97	7.86	2.27	3.46	-	-	-
35/24	8.50	1.06	8.05	9.29	1.46	6.34	8.16	1.80	4.72	-	-	-	-	-	-	
5.1	-25/-	3.78	2.28	1.66	2.96	2.26	1.31	-	-	-	-	-	-	-	-	-
	-20/-20.1	4.98	2.34	2.13	3.89	2.39	1.63	2.75	2.18	1.26	-	-	-	-	-	-
	-15/-15.3	6.43	2.62	2.46	5.57	2.76	2.02	5.20	3.04	1.71	4.20	2.96	1.42	-	-	-
	-10/-11	7.89	2.65	2.98	7.38	3.10	2.38	6.67	3.58	1.86	5.38	3.15	1.71	-	-	-
	-7/-8	8.31	2.61	3.11	7.68	3.05	2.52	7.05	3.53	1.97	5.61	3.10	1.81	-	-	-
	-5/-6	8.80	2.64	3.33	8.18	3.09	2.65	7.53	3.32	2.27	6.13	3.10	1.98	-	-	-
	-2/-3	9.26	2.59	3.59	8.61	3.10	2.78	7.92	3.31	2.39	6.65	3.22	2.06	-	-	-
	0/-1	9.56	2.55	3.76	8.89	3.10	2.87	8.18	3.31	2.47	6.99	3.30	2.12	-	-	-
	2/1	9.78	2.43	4.06	9.25	3.01	3.08	8.54	3.29	2.59	7.33	3.26	2.25	-	-	-
	7/6	10.30	2.09	4.93	10.30	2.73	3.77	9.72	3.20	3.04	8.23	2.96	2.78	4.85	3.11	1.56
	15/12	10.20	1.73	5.90	10.10	2.39	4.22	9.76	2.76	3.54	8.43	2.70	3.13	6.56	2.71	2.43
	20/15	10.70	1.59	6.72	10.30	2.12	4.86	9.85	2.54	3.88	8.90	2.56	3.48	-	-	-
35/24	9.25	1.11	8.30	10.30	1.61	6.40	9.42	1.90	4.96	-	-	-	-	-	-	

kWt: delivered heat capacity [kW].

kWe: electrical power absorbed [kW].

Tae: outdoor air temperature [°C].

Performance in relation to the difference between inlet and outlet water temperature = 5 °C

Note: the data are at maximum operation according to EN 14511:2018

The values indicate the integrated heat capacity: the current heat capacity considering any defrosting cycles

Performance in heating

Sizes	Tae (°C) DB/WB	Water supply temperature (°C)														
		35			45			55			60			65		
		°C	kWt	kWe	COP	kWt	kWe	COP	kWt	kWe	COP	kWt	kWe	COP	kWt	kWe
6.1	-25/-	5.03	2.96	1.70	4.23	3.29	1.28	-	-	-	-	-	-	-	-	-
	-20/-20.1	7.21	3.34	2.16	6.05	3.52	1.72	5.08	3.63	1.40	-	-	-	-	-	-
	-15/-15.3	8.86	3.62	2.45	7.39	3.95	1.87	6.33	4.31	1.47	5.87	4.69	1.25	-	-	-
	-10/-11	10.00	3.95	2.54	9.32	4.54	2.05	8.60	4.79	1.79	6.70	5.13	1.30	-	-	-
	-7/-8	11.00	3.89	2.83	10.40	4.50	2.31	10.60	5.25	2.02	8.05	5.06	1.59	-	-	-
	-5/-6	11.30	3.87	2.92	10.90	4.61	2.37	10.60	5.14	2.05	8.21	5.14	1.60	-	-	-
	-2/-3	11.72	3.61	3.26	11.74	4.47	2.63	10.72	4.90	2.18	8.40	5.07	1.65	-	-	-
	0/-1	12.00	3.44	3.48	12.30	4.37	2.81	10.80	4.74	2.27	8.52	5.03	1.69	-	-	-
	2/1	12.64	3.38	3.75	12.82	4.29	2.99	11.60	4.72	2.45	9.75	5.04	1.93	-	-	-
	7/6	14.60	3.11	4.69	14.50	4.00	3.63	13.90	4.66	2.97	13.00	5.07	2.56	11.50	5.17	2.23
	15/12	14.40	2.65	5.43	14.60	3.53	4.14	12.10	3.97	3.03	12.30	4.32	2.85	11.70	4.42	2.65
	20/15	14.20	2.20	6.47	14.80	3.15	4.69	12.00	3.55	3.39	10.80	3.71	2.90	-	-	-
	35/24	14.70	1.80	8.16	14.60	2.50	5.83	12.90	2.79	4.62	-	-	-	-	-	-
7.1	-25/-	5.43	3.18	1.71	4.47	3.47	1.29	-	-	-	-	-	-	-	-	-
	-20/-20.1	7.79	3.58	2.18	6.25	3.61	1.73	5.14	3.87	1.33	-	-	-	-	-	-
	-15/-15.3	9.57	3.94	2.43	7.63	4.12	1.85	6.46	4.58	1.41	6.01	5.05	1.19	-	-	-
	-10/-11	11.00	4.44	2.47	9.64	4.73	2.04	8.72	5.21	1.67	6.73	5.30	1.27	-	-	-
	-7/-8	12.70	4.55	2.79	11.90	5.17	2.31	11.30	5.46	2.01	8.02	5.31	1.51	-	-	-
	-5/-6	12.50	4.16	2.99	12.10	4.99	2.42	11.10	5.32	2.09	8.25	5.06	1.63	-	-	-
	-2/-3	12.44	3.96	3.15	12.46	4.91	2.54	11.52	5.24	2.20	8.90	5.31	1.67	-	-	-
	0/-1	12.40	3.82	3.26	12.70	4.85	2.62	11.80	5.19	2.27	9.34	5.48	1.70	-	-	-
	2/1	13.16	3.74	3.53	13.34	4.75	2.82	12.60	5.19	2.43	10.28	5.44	1.89	-	-	-
	7/6	15.50	3.37	4.59	15.70	4.35	3.60	14.50	4.92	2.95	13.20	5.20	2.54	10.40	4.95	2.10
	15/12	15.20	2.94	5.16	15.50	3.98	3.89	13.00	4.02	3.24	12.70	4.48	2.84	11.90	4.97	2.41
	20/15	14.60	2.59	5.65	15.10	3.42	4.42	12.70	3.62	3.52	11.00	3.77	2.92	-	-	-
	35/24	15.00	1.87	8.02	15.30	2.65	5.77	13.00	2.77	4.69	-	-	-	-	-	-
8.1	-25/-	6.61	4.01	1.65	4.96	4.21	1.18	-	-	-	-	-	-	-	-	-
	-20/-20.1	8.16	4.77	1.71	6.55	4.85	1.35	5.37	4.75	1.13	-	-	-	-	-	-
	-15/-15.3	10.70	4.93	2.17	9.03	5.38	1.68	6.82	5.29	1.29	6.42	5.59	1.15	-	-	-
	-10/-11	12.70	5.09	2.49	11.10	5.61	1.96	8.92	5.88	1.51	7.04	5.59	1.26	-	-	-
	-7/-8	13.90	5.19	2.67	13.10	6.02	2.18	12.60	6.29	2.00	8.25	6.18	1.33	-	-	-
	-5/-6	14.00	4.93	2.86	13.40	5.88	2.28	12.60	5.92	2.13	8.62	5.97	1.45	-	-	-
	-2/-3	14.18	4.53	3.15	13.82	5.55	2.50	12.72	5.62	2.27	9.18	5.71	1.61	-	-	-
	0/-1	14.30	4.27	3.34	14.10	5.33	2.64	12.80	5.42	2.37	9.56	5.54	1.72	-	-	-
	2/1	15.02	4.16	3.62	14.82	5.18	2.86	13.48	5.34	2.53	10.82	5.47	1.98	-	-	-
	7/6	16.80	3.79	4.43	16.60	4.71	3.53	16.20	5.53	2.89	14.10	5.34	2.63	11.30	5.13	2.20
	15/12	18.90	3.48	5.43	18.50	4.53	4.09	17.50	5.11	3.42	14.70	4.83	3.06	12.50	4.80	2.60
	20/15	16.70	2.69	6.21	16.10	3.77	4.28	15.00	4.32	3.46	13.10	4.39	3.00	-	-	-
	35/24	16.30	1.94	8.42	15.90	2.79	5.68	13.40	3.07	4.35	-	-	-	-	-	-

kWt: delivered heat capacity [kW].

kWe: electrical power absorbed [kW].

Tae: outdoor air temperature [°C].

Performance in relation to the difference between inlet and outlet water temperature = 5°C

Note: the data are at maximum operation according to EN 14511:2018

The values indicate the integrated heat capacity: the current heat capacity considering any defrosting cycles

Performance in heating

Sizes	Tae (°C) DB/WB	Water supply temperature (°C)														
		35			45			55			60			65		
		°C	kWt	kWe	COP	kWt	kWe	COP	kWt	kWe	COP	kWt	kWe	COP	kWt	kWe
6.1T	-25/-	5.03	2.96	1.70	4.23	3.29	1.28	-	-	-	-	-	-	-	-	-
	-20/-20.1	7.21	3.34	2.16	6.05	3.52	1.72	5.08	3.63	1.40	-	-	-	-	-	-
	-15/-15.3	8.86	3.62	2.45	7.39	3.95	1.87	6.33	4.31	1.47	5.87	4.69	1.25	-	-	-
	-10/-11	10.00	3.95	2.54	9.32	4.54	2.05	8.60	4.79	1.79	6.70	5.13	1.30	-	-	-
	-7/-8	11.00	3.89	2.83	10.40	4.50	2.31	10.60	5.25	2.02	8.05	5.06	1.59	-	-	-
	-5/-6	11.30	3.87	2.92	10.90	4.61	2.37	10.60	5.14	2.05	8.21	5.14	1.60	-	-	-
	-2/-3	11.72	3.61	3.26	11.74	4.47	2.63	10.72	4.90	2.18	8.40	5.07	1.65	-	-	-
	0/-1	12.00	3.44	3.48	12.30	4.37	2.81	10.80	4.74	2.27	8.52	5.03	1.69	-	-	-
	2/1	12.64	3.38	3.75	12.82	4.29	2.99	11.60	4.72	2.45	9.75	5.04	1.93	-	-	-
	7/6	14.60	3.11	4.69	14.50	4.00	3.63	13.90	4.66	2.97	13.00	5.07	2.56	11.50	5.17	2.23
	15/12	14.40	2.65	5.43	14.60	3.53	4.14	12.10	3.97	3.03	12.30	4.32	2.85	11.70	4.42	2.65
	20/15	14.20	2.20	6.47	14.80	3.15	4.69	12.00	3.55	3.39	10.80	3.71	2.90	-	-	-
35/24	14.70	1.80	8.16	14.60	2.50	5.83	12.90	2.79	4.62	-	-	-	-	-	-	
7.1T	-25/-	5.43	3.18	1.71	4.47	3.47	1.29	-	-	-	-	-	-	-	-	-
	-20/-20.1	7.79	3.58	2.18	6.25	3.61	1.73	5.14	3.87	1.33	-	-	-	-	-	-
	-15/-15.3	9.57	3.94	2.43	7.63	4.12	1.85	6.46	4.58	1.41	6.01	5.05	1.19	-	-	-
	-10/-11	11.00	4.44	2.47	9.64	4.73	2.04	8.72	5.21	1.67	6.73	5.30	1.27	-	-	-
	-7/-8	12.70	4.55	2.79	11.90	5.17	2.31	11.30	5.46	2.01	8.02	5.31	1.51	-	-	-
	-5/-6	12.50	4.16	2.99	12.10	4.99	2.42	11.10	5.32	2.09	8.25	5.06	1.63	-	-	-
	-2/-3	12.44	3.96	3.15	12.46	4.91	2.54	11.52	5.24	2.20	8.90	5.31	1.67	-	-	-
	0/-1	12.40	3.82	3.26	12.70	4.85	2.62	11.80	5.19	2.27	9.34	5.48	1.70	-	-	-
	2/1	13.16	3.74	3.53	13.34	4.75	2.82	12.60	5.19	2.43	10.28	5.44	1.89	-	-	-
	7/6	15.50	3.37	4.59	15.70	4.35	3.60	14.50	4.92	2.95	13.20	5.20	2.54	10.40	4.95	2.10
	15/12	15.20	2.94	5.16	15.50	3.98	3.89	13.00	4.02	3.24	12.70	4.48	2.84	11.90	4.97	2.41
	20/15	14.60	2.59	5.65	15.10	3.42	4.42	12.70	3.62	3.52	11.00	3.77	2.92	-	-	-
35/24	15.00	1.87	8.02	15.30	2.65	5.77	13.00	2.77	4.69	-	-	-	-	-	-	
8.1T	-25/-	6.61	4.01	1.65	4.96	4.21	1.18	-	-	-	-	-	-	-	-	-
	-20/-20.1	8.16	4.77	1.71	6.55	4.85	1.35	5.37	4.75	1.13	-	-	-	-	-	-
	-15/-15.3	10.70	4.93	2.17	9.03	5.38	1.68	6.82	5.29	1.29	6.42	5.59	1.15	-	-	-
	-10/-11	12.70	5.09	2.49	11.10	5.61	1.96	8.92	5.88	1.51	7.04	5.59	1.26	-	-	-
	-7/-8	13.90	5.19	2.67	13.10	6.02	2.18	12.60	6.29	2.00	8.25	6.18	1.33	-	-	-
	-5/-6	14.00	4.93	2.86	13.40	5.88	2.28	12.60	5.92	2.13	8.62	5.97	1.45	-	-	-
	-2/-3	14.18	4.53	3.15	13.82	5.55	2.50	12.72	5.62	2.27	9.18	5.71	1.61	-	-	-
	0/-1	14.30	4.27	3.34	14.10	5.33	2.64	12.80	5.42	2.37	9.56	5.54	1.72	-	-	-
	2/1	15.02	4.16	3.62	14.82	5.18	2.86	13.48	5.34	2.53	10.82	5.47	1.98	-	-	-
	7/6	16.80	3.79	4.43	16.60	4.71	3.53	16.20	5.53	2.89	14.10	5.34	2.63	11.30	5.13	2.20
	15/12	18.90	3.48	5.43	18.50	4.53	4.09	17.50	5.11	3.42	14.70	4.83	3.06	12.50	4.80	2.60
	20/15	16.70	2.69	6.21	16.10	3.77	4.28	15.00	4.32	3.46	13.10	4.39	3.00	-	-	-
35/24	15.40	2.00	7.68	15.30	2.81	5.46	13.20	3.15	4.18	12.70	4.11	3.10	-	-	-	

kWt: delivered heat capacity [kW].

kWe: electrical power absorbed [kW].

Tae: outdoor air temperature [°C].

Performance in relation to the difference between inlet and outlet water temperature = 5°C

Note: the data are at maximum operation according to EN 14511:2018

The values indicate the integrated heat capacity: the current heat capacity considering any defrosting cycles

Performance in heating

Sizes	Tae (°C) DB/WB	Water supply temperature (°C)														
		35			45			55			60			65		
		°C	kWt	kWe	COP	kWt	kWe	COP	kWt	kWe	COP	kWt	kWe	COP	kWt	kWe
9.1	-25/-	7.84	6.52	1.20	-	-	-	-	-	-	-	-	-	-	-	-
	-20/-20.1	9.96	6.12	1.63	-	-	-	-	-	-	-	-	-	-	-	-
	-15/-15.3	14.69	6.97	2.11	12.44	8.74	1.42	-	-	-	-	-	-	-	-	-
	-10/-11	17.95	7.87	2.28	15.06	8.53	1.76	9.17	8.35	1.10	6.10	5.83	1.05	-	-	-
	-7/-8	19.91	8.41	2.37	16.16	8.17	1.98	10.08	8.52	1.18	8.04	7.44	1.08	-	-	-
	-5/-6	20.96	8.28	2.53	17.58	8.46	2.08	10.95	8.54	1.28	9.39	8.04	1.17	-	-	-
	-2/-3	20.52	7.35	2.79	17.57	7.89	2.23	12.61	8.87	1.42	10.72	8.82	1.22	-	-	-
	0/-1	19.37	6.51	2.97	18.23	7.48	2.44	15.17	8.56	1.77	13.56	8.81	1.54	-	-	-
	2/1	20.23	6.40	3.16	19.97	7.56	2.64	17.74	8.25	2.15	16.84	8.57	1.96	-	-	-
	7/6	20.74	5.31	3.90	18.45	5.90	3.13	18.40	7.71	2.39	18.38	8.61	2.13	-	-	-
	15/12	22.08	5.11	4.32	20.89	5.37	3.89	19.18	5.95	3.22	19.03	6.42	2.96	-	-	-
20/15	23.78	5.33	4.46	21.28	5.22	4.08	20.38	5.92	3.44	19.94	6.27	3.18	-	-	-	
35/24	12.48	1.90	6.58	11.91	2.27	5.24	11.13	2.92	3.81	-	-	-	-	-	-	
10.1	-25/-	8.06	6.89	1.17	-	-	-	-	-	-	-	-	-	-	-	-
	-20/-20.1	10.22	6.19	1.65	-	-	-	-	-	-	-	-	-	-	-	-
	-15/-15.3	15.91	7.35	2.17	13.76	10.91	1.26	-	-	-	-	-	-	-	-	-
	-10/-11	19.27	8.20	2.35	17.55	10.19	1.72	10.65	10.01	1.06	7.44	7.23	1.03	-	-	-
	-7/-8	21.28	8.70	2.44	19.82	9.75	2.03	12.55	10.03	1.25	9.20	7.90	1.16	-	-	-
	-5/-6	22.11	8.61	2.57	20.87	9.85	2.12	13.81	10.05	1.37	10.73	8.99	1.19	-	-	-
	-2/-3	23.36	8.47	2.76	22.44	9.99	2.25	15.71	10.07	1.56	13.39	10.07	1.33	-	-	-
	0/-1	22.47	7.78	2.89	21.57	9.06	2.38	18.38	10.00	1.84	16.51	10.15	1.63	-	-	-
	2/1	23.24	7.69	3.02	23.02	9.16	2.51	21.04	9.93	2.12	19.63	10.01	1.96	-	-	-
	7/6	24.93	6.47	3.85	22.66	7.51	3.02	22.78	9.09	2.51	22.44	10.55	2.13	-	-	-
	15/12	28.05	6.79	4.13	26.31	7.40	3.56	24.59	7.91	3.11	23.73	8.17	2.90	-	-	-
20/15	27.75	6.41	4.33	25.97	6.88	3.77	23.95	7.25	3.30	22.94	7.43	3.09	-	-	-	
35/24	12.46	1.92	6.48	11.88	2.30	5.17	11.20	2.94	3.81	-	-	-	-	-	-	
12.1	-25/-	8.29	7.27	1.14	-	-	-	-	-	-	-	-	-	-	-	-
	-20/-20.1	10.49	6.25	1.68	-	-	-	-	-	-	-	-	-	-	-	-
	-15/-15.3	17.13	7.72	2.22	13.91	12.25	1.14	-	-	-	-	-	-	-	-	-
	-10/-11	20.58	8.52	2.42	18.62	11.04	1.69	13.20	12.02	1.10	10.31	9.73	1.06	-	-	-
	-7/-8	23.46	9.32	2.52	21.45	10.31	2.08	15.28	11.63	1.31	11.52	9.70	1.19	-	-	-
	-5/-6	23.27	8.95	2.60	22.50	10.44	2.16	16.35	11.16	1.47	12.39	9.99	1.24	-	-	-
	-2/-3	24.20	8.88	2.73	24.07	10.63	2.26	18.39	10.78	1.71	15.97	10.99	1.45	-	-	-
	0/-1	24.82	8.83	2.81	25.12	10.77	2.33	20.97	11.02	1.90	19.22	11.18	1.72	-	-	-
	2/1	25.44	8.78	2.90	26.17	10.90	2.40	23.10	11.05	2.09	21.59	11.02	1.96	-	-	-
	7/6	29.08	8.07	3.60	27.40	9.31	2.94	26.84	11.46	2.34	24.31	11.47	2.12	-	-	-
	15/12	30.79	7.79	3.95	30.62	9.28	3.30	26.56	8.85	3.00	24.91	8.75	2.85	-	-	-
20/15	32.48	7.72	4.21	30.13	8.54	3.53	26.78	8.43	3.18	25.11	8.38	3.00	-	-	-	
35/24	12.43	1.95	6.38	11.85	2.32	5.10	11.26	2.96	3.81	-	-	-	-	-	-	
14.1	-25/-	8.68	8.02	1.08	-	-	-	-	-	-	-	-	-	-	-	-
	-20/-20.1	10.77	6.90	1.56	-	-	-	-	-	-	-	-	-	-	-	-
	-15/-15.3	17.60	8.52	2.06	14.69	13.74	1.07	-	-	-	-	-	-	-	-	-
	-10/-11	21.14	9.40	2.25	19.67	12.38	1.59	14.29	13.64	1.05	10.38	10.22	1.02	-	-	-
	-7/-8	23.26	9.93	2.34	22.66	11.56	1.96	16.54	13.79	1.20	12.23	11.04	1.11	-	-	-
	-5/-6	23.90	9.87	2.42	23.77	11.71	2.03	18.04	13.48	1.34	13.93	11.35	1.23	-	-	-
	-2/-3	24.85	9.80	2.54	25.43	11.93	2.13	19.93	12.79	1.56	17.95	12.82	1.40	-	-	-
	0/-1	25.49	9.74	2.62	26.53	12.08	2.20	22.72	13.08	1.74	21.61	13.04	1.66	-	-	-
	2/1	26.02	9.09	2.86	28.19	12.32	2.29	24.65	12.49	1.97	23.09	11.82	1.95	-	-	-
	7/6	31.75	9.51	3.34	30.99	11.27	2.75	30.56	13.82	2.21	27.33	12.94	2.11	-	-	-
	15/12	32.70	8.64	3.79	36.01	11.64	3.09	32.59	11.24	2.90	27.20	9.76	2.79	-	-	-
20/15	32.98	8.08	4.08	35.34	10.62	3.33	32.48	10.62	3.06	27.14	9.33	2.91	-	-	-	
35/24	12.41	1.97	6.29	11.82	2.35	5.03	11.33	2.98	3.80	-	-	-	-	-	-	

kWt: delivered heat capacity [kW].

kWe: electrical power absorbed [kW].

Tae: outdoor air temperature [°C].

Performance in relation to the difference between inlet and outlet water temperature = 5°C

Note: the data are at maximum operation according to EN 14511:2018

The values indicate the integrated heat capacity: the current heat capacity considering any defrosting cycles

Data for calculation UNI/TS 11300-4

Data for Energy Certification

Data to be used for the calculation of the energy performance of the building, referring to the energy efficiency of heat pump generation. The data provided can be used for calculation according to UNI/TS 11300 - part 4 and refer to the conditions defined in UNI EN 14825. The data may be updated by the manufacturer in the event of updates to the range without obligation of prior notice.

Performance at full load in heating mode

Heating capacity and COP at full load, under the conditions defined in EN 14825.

Sizes	Outdoor air temp.	Heating						Tae	DHW	
		Supply water temperature							Supply water temperature	
		35 °C		45 °C		55 °C			55 °C	
		Heating capacity $\Phi_{H,HP}$ out [kW]	COP	Heating capacity $\Phi_{H,HP}$ out [kW]	COP	Heating capacity $\Phi_{H,HP}$ out [kW]	COP		Heating capacity $\Phi_{H,HP}$ out [kW]	COP
2.1	-7 °C	4.99	3.11	4.54	2.29	4.28	1.83	7 °C	5.74	3.03
	2 °C	5.33	3.98	5.26	3.04	5.29	2.49	15 °C	5.63	3.41
	7 °C	6.26	4.96	5.96	3.67	5.74	3.03	20 °C	5.52	3.68
	12 °C	5.75	4.59	6.20	4.21	5.63	3.41	35 °C	5.61	4.62
3.1	-7 °C	6.21	2.86	5.57	2.35	5.22	1.96	7 °C	6.90	2.91
	2 °C	6.67	4.07	6.93	3.19	5.83	2.32	15 °C	6.98	3.30
	7 °C	7.41	4.76	7.13	3.58	6.90	2.91	20 °C	6.81	3.60
	12 °C	7.30	5.18	7.51	4.01	6.96	3.20	35 °C	6.57	4.45
4.1	-7 °C	7.27	3.21	6.94	2.52	6.22	2.03	7 °C	7.80	3.12
	2 °C	8.71	4.09	8.33	3.12	7.28	2.53	15 °C	8.32	3.55
	7 °C	9.11	5.07	8.98	3.82	7.80	3.12	20 °C	8.43	3.97
	12 °C	9.03	5.79	8.84	4.19	8.27	3.45	35 °C	8.16	4.72
5.1	-7 °C	8.31	3.11	7.68	2.52	7.05	1.97	7 °C	9.72	3.04
	2 °C	9.78	4.06	9.25	3.08	8.54	2.59	15 °C	9.76	3.54
	7 °C	10.30	4.93	10.30	3.77	9.72	3.04	20 °C	9.85	3.88
	12 °C	10.12	5.59	10.01	4.00	9.68	3.36	35 °C	9.42	4.96
6.1	-7 °C	11.00	2.83	10.40	2.31	10.60	2.02	7 °C	13.90	2.97
	2 °C	12.64	3.75	12.82	2.99	11.60	2.45	15 °C	12.10	3.03
	7 °C	14.60	4.69	14.50	3.63	13.90	2.97	20 °C	12.00	3.39
	12 °C	14.36	5.28	14.48	3.96	12.50	3.01	35 °C	12.90	4.62
7.1	-7 °C	12.70	2.79	11.90	2.31	11.30	2.01	7 °C	14.50	2.95
	2 °C	13.16	3.53	13.34	2.82	12.60	2.43	15 °C	13.00	3.24
	7 °C	15.50	4.59	15.70	3.60	14.50	2.95	20 °C	12.70	3.52
	12 °C	15.08	5.01	15.30	3.80	13.48	3.18	35 °C	13.00	4.69
8.1	-7 °C	13.90	2.67	13.10	2.18	12.60	2.00	7 °C	16.20	2.89
	2 °C	15.02	3.62	14.82	2.86	13.48	2.53	15 °C	17.50	3.42
	7 °C	16.80	4.43	16.60	3.53	16.20	2.89	20 °C	15.00	3.46
	12 °C	18.38	5.15	18.02	3.92	16.94	3.30	35 °C	13.40	4.35
6.1T	-7 °C	11.00	2.83	10.40	2.31	10.60	2.02	7 °C	13.90	2.97
	2 °C	12.64	3.75	12.82	2.99	11.60	2.45	15 °C	12.10	3.03
	7 °C	14.60	4.69	14.50	3.63	13.90	2.97	20 °C	12.00	3.39
	12 °C	14.36	5.28	14.48	3.96	12.50	3.01	35 °C	12.90	4.62
7.1T	-7 °C	12.70	2.79	11.90	2.31	11.30	2.01	7 °C	14.50	2.95
	2 °C	13.16	3.53	13.34	2.82	12.60	2.43	15 °C	13.00	3.24
	7 °C	15.50	4.59	15.70	3.60	14.50	2.95	20 °C	12.70	3.52
	12 °C	15.08	5.01	15.30	3.80	13.48	3.18	35 °C	13.00	4.69

Data for calculation UNI/TS 11300-4

Sizes	Outdoor air temp.	Heating						DHW			
		Supply water temperature						Supply water temperature			
		35 °C		45 °C		55 °C		Tae	55 °C		
		Heating capacity ΦH,HP out [kW]	COP	Heating capacity ΦH,HP out [kW]	COP	Heating capacity ΦH,HP out [kW]	COP		Heating capacity ΦH,HP out [kW]	COP	
8.1T	-7 °C	13.90	2.67	13.10	2.18	12.60	2.00	7°C	16.20	2.89	
	2 °C	15.02	3.62	14.82	2.86	13.48	2.53	15°C	17.50	3.42	
	7 °C	16.80	4.43	16.60	3.53	16.20	2.89	20°C	15.00	3.46	
	12 °C	18.38	5.15	18.02	3.92	16.94	3.30	35°C	13.40	4.35	
9.1	-7 °C	19.91	2.37	16.16	1.98	10.08	1.18	7°C	18.40	2.39	
	2 °C	20.23	3.16	19.97	2.64	17.74	2.15	15°C	19.18	3.22	
	7 °C	20.74	3.90	18.45	3.13	18.40	2.39	20°C	20.38	3.44	
	12 °C	21.51	4.22	19.86	3.70	18.77	3.00	35°C	11.13	3.81	
10.1	-7 °C	21.28	2.44	19.82	2.03	12.55	1.25	7°C	22.78	2.51	
	2 °C	23.24	3.02	23.02	2.51	21.04	2.12	15°C	24.59	3.11	
	7 °C	24.93	3.85	22.66	3.02	22.78	2.51	20°C	23.95	3.30	
	12 °C	26.65	4.04	24.87	3.43	23.52	2.92	35°C	11.20	3.81	
12.1	-7 °C	23.46	2.52	21.45	2.08	15.28	1.31	7°C	26.84	2.34	
	2 °C	25.44	2.90	26.17	2.40	23.10	2.09	15°C	26.56	3.00	
	7 °C	29.08	3.60	27.40	2.94	26.84	2.34	20°C	26.78	3.18	
	12 °C	29.82	3.87	29.32	3.22	26.22	2.83	35°C	11.26	3.81	
14.1	-7 °C	23.46	2.52	22.66	1.96	16.54	1.20	7°C	30.56	2.21	
	2 °C	26.02	2.96	28.19	2.29	24.65	1.97	15°C	32.59	2.90	
	7 °C	31.75	3.93	30.99	2.75	30.56	2.21	20°C	32.48	3.06	
	12 °C	31.66	4.11	34.24	3.04	31.62	2.75	35°C	11.33	3.80	

Performance with full load in DHW mode

Heating capacity and COP with full load

Model	Outdoor air temp.	Supply water temperature		Model	Outdoor air temp.	Supply water temperature	
		55 °C				55°C	
		Heating capacity ΦH,HP out [kW]"	COP			Heating capacity ΦH,HP out [kW]"	COP
Size 2.1	7 °C	5.74	3.03	Size 6.1T	7 °C	13.90	2.97
	15 °C	5.63	3.41		15 °C	12.10	3.03
	20 °C	5.52	3.68		20 °C	12.00	3.39
	35 °C	5.61	4.62		35 °C	12.90	4.62
Size 3.1	7 °C	6.90	2.91	Size 7.1T	7 °C	14.50	2.95
	15 °C	6.98	3.30		15 °C	13.00	3.24
	20 °C	6.81	3.60		20 °C	12.70	3.52
	35 °C	6.57	4.45		35 °C	13.00	4.69
Size 4.1	7 °C	7.80	3.12	Size 8.1T	7 °C	16.20	2.89
	15 °C	8.32	3.55		15 °C	17.50	3.42
	20 °C	8.43	3.97		20 °C	15.00	3.46
	35 °C	8.16	4.72		35 °C	13.40	4.35
Size 5.1	7 °C	9.72	3.04	Size 9.1	7 °C	18.40	2.39
	15 °C	9.76	3.54		15 °C	19.18	3.22
	20 °C	9.85	3.88		20 °C	20.38	3.44
	35 °C	9.42	4.96		35 °C	11.13	3.81
Size 6.1	7 °C	13.90	2.97	Size 10.1	7 °C	22.78	2.51
	15 °C	12.10	3.03		15 °C	24.59	3.11
	20 °C	12.00	3.39		20 °C	23.95	3.30
	35 °C	12.90	4.62		35 °C	11.20	3.81
Size 7.1	7 °C	14.50	2.95	Size 12.1	7 °C	26.84	2.34
	15 °C	13.00	3.24		15 °C	26.56	3.00
	20 °C	12.70	3.52		20 °C	26.78	3.18
	35 °C	13.00	4.69		35 °C	11.26	3.81
Size 8.1	7 °C	16.20	2.89	Size 14.1	7 °C	30.56	2.21
	15 °C	17.50	3.42		15 °C	32.59	2.90
	20 °C	15.00	3.46		20 °C	32.48	3.06
	35 °C	13.40	4.35		35 °C	11.33	3.80

Data for calculation UNI/TS 11300-4

Performance with partial loads in Heating mode

Standard UNI/TS 11300 - part 4, taking the Average climate according to UNI EN 14825 as reference, defines a design temperature of -10 °C and operating conditions A = -7 °C (bivalent temperature), B = 2°C, C = 7 °C and D = 12 °C.

The Load Factor (CR) is calculated for each condition; this is the ratio between the load required by the system and the maximum power that can be delivered by the unit. CR therefore represents the unit's capacity to partialise.

Similarly, the Correction Factor (f_{COP}), is the ratio between the efficiency of partialisation and the efficiency at full load.

Size 2.1	T _{designh}	A	B	C	D
Outdoor air temperature	-10 °C	-7 °C	2 °C	7 °C	12 °C
PLR - Climatic load factor	100%	88%	54%	35%	15%
DC - Power with full load	-	4.99	3.04	1.95	1.48
P - Load of the system	5.64	4.99	3.04	1.95	0.87
CR - Load factor of the heat pump	>1	1.00	1.00	5.94	8.92
COP - Efficiency with partial load	-	3.13	4.38	5.21	6.14
COP' - Efficiency with full load	-	3.11	3.98	4.96	4.59
f _{COP} - Correction factor	1	1.01	1.10	1.05	1.43

Size 3.1	T _{designh}	A	B	C	D
Outdoor air temperature	-10 °C	-7 °C	2 °C	7 °C	12 °C
PLR - Climatic load factor	100%	88%	54%	35%	15%
DC - Power with full load	-	6.21	3.78	2.43	1.39
P - Load of the system	7.02	6.21	3.78	11.60	13.20
CR - Load factor of the heat pump	>1	1.00	1.00	4.77	9.50
COP - Efficiency with partial load	-	3.03	4.44	5.64	6.29
COP' - Efficiency with full load	-	2.86	4.07	4.76	5.18
f _{COP} - Correction factor	1	1.06	1.09	1.18	1.25

Size 4.1	T _{designh}	A	B	C	D
Outdoor air temperature	-10 °C	-7 °C	2 °C	7 °C	12 °C
PLR - Climatic load factor	100%	88%	54%	35%	15%
DC - Power with full load	-	7.27	4.43	2.84	1.63
P - Load of the system	8.22	7.27	4.43	11.60	13.20
CR - Load factor of the heat pump	>1	1.00	1.00	4.08	8.10
COP - Efficiency with partial load	-	3.28	4.66	5.80	6.62
COP' - Efficiency with full load	-	3.21	4.09	5.07	5.79
f _{COP} - Correction factor	1	1.02	1.14	1.14	1.18

Size 5.1	T _{designh}	A	B	C	D
Outdoor air temperature	-10 °C	-7 °C	2 °C	7 °C	12 °C
PLR - Climatic load factor	100%	88%	54%	35%	15%
DC - Power with full load	-	8.31	5.06	3.25	1.65
P - Load of the system	9.39	8.31	5.06	11.60	13.20
CR - Load factor of the heat pump	>1	1.00	1.00	3.57	8.00
COP - Efficiency with partial load	-	3.17	4.59	6.02	6.90
COP' - Efficiency with full load	-	3.11	4.06	4.93	5.59
f _{COP} - Correction factor	1	1.02	1.13	1.22	1.25

Size 6.1	T _{designh}	A	B	C	D
Outdoor air temperature	-10 °C	-7 °C	2 °C	7 °C	12 °C
PLR - Climatic load factor	100%	88%	54%	35%	15%
DC - Power with full load	-	11.00	6.70	4.30	3.74
P - Load of the system	12.43	11.00	6.70	11.60	13.20
CR - Load factor of the heat pump	>1	1.00	1.00	2.69	3.53
COP - Efficiency with partial load	-	2.82	4.26	5.63	6.31
COP' - Efficiency with full load	-	2.83	3.75	4.69	5.28
f _{COP} - Correction factor	1	1.00	1.14	1.20	1.31

Size 7.1	T _{designh}	A	B	C	D
Outdoor air temperature	-10 °C	-7 °C	2 °C	7 °C	12 °C
PLR - Climatic load factor	100%	88%	54%	35%	15%
DC - Power with full load	-	12.70	7.73	4.97	3.75
P - Load of the system	14.36	12.70	7.73	11.60	13.20
CR - Load factor of the heat pump	>1	1.00	1.00	2.33	3.52
COP - Efficiency with partial load	-	2.73	4.14	5.68	6.50
COP' - Efficiency with full load	-	2.79	3.53	4.59	5.01
f _{COP} - Correction factor	1	0.98	1.17	1.24	1.39

Size 8.1	T _{designh}	A	B	C	D
Outdoor air temperature	-10 °C	-7 °C	2 °C	7 °C	12 °C
PLR - Climatic load factor	100%	88%	54%	35%	15%
DC - Power with full load	-	13.90	8.46	5.44	3.78
P - Load of the system	15.71	13.90	8.46	11.60	13.20
CR - Load factor of the heat pump	>1	1.00	1.00	2.13	3.49
COP - Efficiency with partial load	-	2.67	4.04	5.58	6.57
COP' - Efficiency with full load	-	2.67	3.62	4.43	5.15
f _{COP} - Correction factor	1	1.00	1.12	1.26	1.35

Size 6.1T	T _{designh}	A	B	C	D
Outdoor air temperature	-10 °C	-7 °C	2 °C	7 °C	12 °C
PLR - Climatic load factor	100%	88%	54%	35%	15%
DC - Power with full load	-	11.00	6.70	4.30	3.74
P - Load of the system	12.43	11.00	6.70	11.60	13.20
CR - Load factor of the heat pump	>1	1.00	1.00	2.69	3.53
COP - Efficiency with partial load	-	2.82	4.26	5.63	6.31
COP' - Efficiency with full load	-	2.83	3.75	4.69	5.28
f _{COP} - Correction factor	1	1.00	1.14	1.20	1.31

Data for calculation UNI/TS 11300-4

Size 7.1T	T_{designh}	A	B	C	D
Outdoor air temperature	-10 °C	-7 °C	2 °C	7 °C	12 °C
PLR - Climatic load factor	100%	88%	54%	35%	15%
DC - Power with full load	-	12.70	7.73	4.97	3.75
P - Load of the system	14.36	12.70	7.73	11.60	13.20
CR - Load factor of the heat pump	>1	1.00	1.00	2.33	3.52
COP - Efficiency with partial load	-	2.73	4.14	5.68	6.50
COP' - Efficiency with full load	-	2.79	3.53	4.59	5.01
f _{COP} - Correction factor	1	0.98	1.17	1.24	1.39

Size 8.1T	T_{designh}	A	B	C	D
Outdoor air temperature	-10 °C	-7 °C	2 °C	7 °C	12 °C
PLR - Climatic load factor	100%	88%	54%	35%	15%
DC - Power with full load	-	13.90	8.46	5.44	3.78
P - Load of the system	15.71	13.90	8.46	11.60	13.20
CR - Load factor of the heat pump	>1	1.00	1.00	2.13	3.49
COP - Efficiency with partial load	-	2.67	4.04	5.58	6.57
COP' - Efficiency with full load	-	2.67	3.62	4.43	5.15
f _{COP} - Correction factor	1	1.00	1.12	1.26	1.35

Size 9.1	T_{designh}	A	B	C	D
Outdoor air temperature	-10 °C	-7 °C	2 °C	7 °C	12 °C
PLR - Climatic load factor	100%	88%	54%	35%	15%
DC - Power with full load	-	19.91	12.12	7.79	3.77
P - Load of the system	22.50	19.91	12.12	11.60	13.20
CR - Load factor of the heat pump	>1	1.00	1.00	1.49	3.50
COP - Efficiency with partial load	-	2.79	4.18	5.06	5.64
COP' - Efficiency with full load	-	2.37	3.16	3.90	4.22
f _{COP} - Correction factor	1	1.18	1.32	1.30	1.35

Size 10.1	T_{designh}	A	B	C	D
Outdoor air temperature	-10 °C	-7 °C	2 °C	7 °C	12 °C
PLR - Climatic load factor	100%	88%	54%	35%	15%
DC - Power with full load	-	21.28	12.95	8.33	3.81
P - Load of the system	24.05	21.28	12.95	11.60	13.20
CR - Load factor of the heat pump	>1	1.00	1.00	1.39	3.46
COP - Efficiency with partial load	-	2.69	4.03	5.31	5.70
COP' - Efficiency with full load	-	2.44	3.02	3.85	4.04
f _{COP} - Correction factor	1	1.10	1.33	1.38	1.41

Size 12.1	T_{designh}	A	B	C	D
Outdoor air temperature	-10 °C	-7 °C	2 °C	7 °C	12 °C
PLR - Climatic load factor	100%	88%	54%	35%	15%
DC - Power with full load	-	23.46	14.28	9.18	4.11
P - Load of the system	26.52	23.46	14.28	11.60	13.20
CR - Load factor of the heat pump	>1	1.00	1.00	1.26	3.21
COP - Efficiency with partial load	-	2.51	4.04	5.47	5.77
COP' - Efficiency with full load	-	2.52	2.90	3.60	3.87
f _{COP} - Correction factor	1	1.00	1.39	1.52	1.49

Size 14.1	T_{designh}	A	B	C	D
Outdoor air temperature	-10 °C	-7 °C	2 °C	7 °C	12 °C
PLR - Climatic load factor	100%	88%	54%	35%	15%
DC - Power with full load	-	23.46	14.16	9.10	4.59
P - Load of the system	26.30	23.46	14.16	11.60	13.20
CR - Load factor of the heat pump	>1	1.00	1.00	1.27	2.88
COP - Efficiency with partial load	-	2.48	3.77	5.28	5.75
COP' - Efficiency with full load	-	2.52	2.96	3.93	4.11
f _{COP} - Correction factor	1	0.98	1.27	1.34	1.42

Performance in cooling

Sizes	Tae	Water supply temperature (°C)																	
		5			7			10			12			15			18		
		°C	kWf	kWe	EER	kWf	kWe	EER	kWf	kWe	EER	kWf	kWe	EER	kWf	kWe	EER	kWf	kWe
2.1	20	4,72	1,04	4,53	5,24	1,16	4,51	6,01	1,35	4,47	7,80	1,61	4,49	8,16	1,49	5,47	8,26	1,38	6,04
	25	5,87	1,30	4,51	6,31	1,52	4,23	6,97	1,84	3,80	7,89	1,64	4,53	8,23	1,53	5,39	8,40	1,41	6,00
	30	5,84	1,55	3,78	6,22	1,67	3,74	6,80	1,85	3,67	7,43	1,75	4,06	7,77	1,65	4,72	8,02	1,54	5,27
	35	5,80	1,79	3,24	6,14	1,82	3,36	6,64	1,87	3,55	6,97	1,85	3,64	7,31	1,76	4,15	7,65	1,65	4,65
	40	3,80	1,51	2,52	4,31	1,63	2,64	5,08	1,81	2,81	5,20	1,75	2,92	5,91	1,73	3,41	6,34	1,70	3,73
	43	2,58	1,15	2,24	3,07	1,30	2,35	3,80	1,52	2,51	4,14	1,55	2,70	5,08	1,56	3,26	5,56	1,57	3,55
3.1	20	5,41	1,38	3,93	6,10	1,42	4,27	6,63	1,43	4,62	7,80	1,61	4,49	8,16	1,49	5,47	8,26	1,38	6,04
	25	7,16	1,80	3,98	7,27	1,79	4,07	7,37	1,77	4,17	7,89	1,64	4,53	8,23	1,53	5,39	8,40	1,41	6,00
	30	6,50	1,85	3,51	7,15	1,95	3,67	7,29	1,90	3,84	7,43	1,75	4,06	7,77	1,65	4,72	8,02	1,54	5,27
	35	6,04	2,04	2,96	7,11	2,39	2,97	7,22	2,03	3,55	6,97	1,85	3,64	7,31	1,76	4,15	7,65	1,65	4,65
	40	3,80	1,51	2,52	4,51	1,69	2,66	5,08	1,81	2,81	5,20	1,75	2,92	5,91	1,73	3,41	6,34	1,70	3,73
	43	2,58	1,15	2,24	3,24	1,37	2,37	3,80	1,52	2,51	4,14	1,55	2,70	5,08	1,56	3,26	5,56	1,57	3,55
4.1	20	5,68	1,15	4,96	6,23	1,21	5,16	7,06	1,29	5,46	7,80	1,31	6,00	8,38	1,35	6,22	9,54	1,50	6,35
	25	6,47	1,48	4,36	7,01	1,54	4,54	7,82	1,63	4,81	8,32	1,60	5,27	9,26	1,68	5,52	10,45	1,81	5,76
	30	7,27	1,89	3,85	7,79	1,94	4,01	8,57	2,01	4,25	8,86	1,94	4,64	10,15	2,06	4,93	11,38	2,14	5,30
	35	7,39	2,25	3,28	7,94	2,27	3,49	8,77	2,31	3,80	9,12	2,25	4,12	10,21	2,31	4,43	11,13	2,36	4,71
	40	6,61	2,52	2,62	6,93	2,46	2,83	7,42	2,37	3,14	7,71	2,36	3,33	8,88	2,53	3,51	9,69	2,52	3,85
	43	5,09	2,28	2,23	5,31	2,24	2,37	5,64	2,19	2,58	5,63	1,96	2,97	6,73	2,13	3,16	7,58	2,15	3,51
5.1	20	6,20	1,28	4,86	6,60	1,32	4,98	7,19	1,39	5,17	7,62	1,42	5,46	8,67	1,45	5,97	9,94	1,56	6,33
	25	7,13	1,68	4,24	7,58	1,73	4,37	8,26	1,81	4,56	8,70	1,81	4,87	9,87	1,88	5,24	11,15	1,99	5,57
	30	8,06	2,17	3,71	8,57	2,23	3,85	9,34	2,31	4,05	9,79	2,27	4,39	11,08	2,40	4,62	12,36	2,50	4,93
	35	8,13	2,48	3,12	8,67	2,46	3,36	9,48	2,43	3,72	9,95	2,52	4,00	11,03	2,62	4,21	12,03	2,66	4,52
	40	6,61	2,52	2,62	6,93	2,46	2,83	7,42	2,37	3,14	7,71	2,36	3,33	8,88	2,53	3,51	9,69	2,52	3,85
	43	5,09	2,28	2,23	5,31	2,24	2,37	5,64	2,19	2,58	5,63	1,96	2,97	6,73	2,13	3,16	7,58	2,15	3,51
6.1	20	7,78	2,03	3,83	9,53	2,40	3,94	12,15	2,96	4,10	13,72	3,28	4,11	14,16	3,12	4,54	15,22	3,13	4,86
	25	10,10	3,00	3,37	11,58	3,24	3,55	13,80	3,61	3,82	15,70	4,20	3,65	15,82	3,91	4,04	16,53	3,97	4,16
	30	9,99	3,58	2,79	11,37	3,80	2,97	13,43	4,13	3,25	15,14	4,39	3,40	15,18	4,17	3,64	15,77	4,16	3,80
	35	9,89	4,52	2,19	11,50	4,18	2,75	13,07	4,90	2,67	14,51	4,77	3,01	14,53	4,56	3,19	15,02	4,45	3,38
	40	8,11	4,53	1,79	8,81	4,45	1,99	9,87	4,33	2,28	10,01	4,06	2,44	10,67	3,92	2,72	11,58	4,00	2,89
	43	5,20	3,72	1,40	5,56	3,54	1,59	6,11	3,26	1,87	6,11	2,97	2,10	7,33	3,02	2,43	8,05	3,12	2,57
7.1	20	8,17	2,17	3,77	10,02	2,57	3,88	12,80	3,16	4,04	14,51	3,50	4,04	14,90	3,33	4,47	15,50	3,22	4,84
	25	10,60	3,19	3,32	12,16	3,45	3,50	14,50	3,84	3,77	16,52	4,47	3,59	16,60	4,16	3,99	16,84	4,07	4,14
	30	10,50	3,96	2,65	11,94	4,19	2,83	14,10	4,53	3,11	15,93	4,82	3,23	15,90	4,56	3,49	16,08	4,33	3,72
	35	10,40	4,81	2,16	12,40	4,96	2,50	13,70	5,32	2,58	15,30	5,08	2,97	15,30	4,88	3,13	15,30	4,62	3,32
	40	8,11	4,53	1,79	8,81	4,45	1,99	9,87	4,33	2,28	10,06	4,06	2,44	10,70	3,92	2,72	11,60	4,00	2,89
	43	5,20	3,72	1,40	5,56	3,54	1,59	6,11	3,26	1,87	6,10	2,97	2,10	7,33	3,02	2,43	8,05	3,12	2,57
8.1	20	8,99	2,43	3,70	10,99	2,88	3,80	14,00	3,55	3,96	15,40	3,74	3,99	15,80	3,56	4,42	16,46	3,44	4,79
	25	11,70	3,59	3,25	13,38	3,88	3,43	15,90	4,32	3,69	17,36	4,80	3,51	17,40	4,47	3,90	17,70	4,37	4,04
	30	11,50	4,46	2,59	13,10	4,72	2,77	15,50	5,11	3,04	17,31	5,42	3,11	17,20	5,05	3,41	17,14	4,82	3,57
	35	11,40	5,42	2,11	14,00	5,60	2,50	15,10	6,00	2,52	16,57	5,90	2,73	16,50	5,60	2,94	16,38	5,22	3,14
	40	8,92	5,11	1,75	9,71	5,02	1,94	10,90	4,89	2,22	10,94	4,57	2,38	11,70	4,42	2,65	12,72	4,58	2,78
	43	5,98	4,50	1,33	6,52	4,35	1,51	7,33	4,12	1,78	8,11	4,04	1,99	9,01	3,91	2,31	9,90	4,04	2,45

kWf: delivered cooling capacity [kW].

kWe: electrical power absorbed [kW].

Tae: outdoor air temperature [°C].

Performance in relation to the difference between inlet and outlet water temperature = 5 °C

Note: the data are at maximum operation according to EN 14511:2018

Performance in cooling

Sizes	Tae	Water supply temperature (°C)																	
		5			7			10			12			15			18		
		°C	kWf	kWe	EER	kWf	kWe	EER	kWf	kWe	EER	kWf	kWe	EER	kWf	kWe	EER	kWf	kWe
6.1T	20	7,78	2,03	3,83	9,53	2,40	3,94	12,15	2,96	4,10	13,72	3,28	4,11	14,16	3,12	4,54	15,22	3,13	4,86
	25	10,10	3,00	3,37	11,58	3,24	3,55	13,80	3,61	3,82	15,70	4,20	3,65	15,82	3,91	4,04	16,53	3,97	4,16
	30	9,99	3,58	2,79	11,37	3,80	2,97	13,43	4,13	3,25	15,14	4,39	3,40	15,18	4,17	3,64	15,77	4,16	3,80
	35	9,89	4,52	2,19	11,50	4,18	2,75	13,07	4,90	2,67	14,51	4,77	3,01	14,53	4,56	3,19	15,02	4,45	3,38
	40	8,11	4,53	1,79	8,81	4,45	1,99	9,87	4,33	2,28	10,01	4,06	2,44	10,67	3,92	2,72	11,58	4,00	2,89
	43	5,20	3,72	1,40	5,56	3,54	1,59	6,11	3,26	1,87	6,11	2,97	2,10	7,33	3,02	2,43	8,05	3,12	2,57
7.1T	20	8,17	2,17	3,77	10,02	2,57	3,88	12,80	3,16	4,04	14,51	3,50	4,04	14,90	3,33	4,47	15,50	3,22	4,84
	25	10,60	3,19	3,32	12,16	3,45	3,50	14,50	3,84	3,77	16,52	4,47	3,59	16,60	4,16	3,99	16,84	4,07	4,14
	30	10,50	3,96	2,65	11,94	4,19	2,83	14,10	4,53	3,11	15,93	4,82	3,23	15,90	4,56	3,49	16,08	4,33	3,72
	35	10,40	4,81	2,16	12,40	4,96	2,50	13,70	5,32	2,58	15,30	5,08	2,97	15,30	4,88	3,13	15,30	4,62	3,32
	40	8,11	4,53	1,79	8,81	4,45	1,99	9,87	4,33	2,28	10,06	4,06	2,44	10,70	3,92	2,72	11,60	4,00	2,89
	43	5,20	3,72	1,40	5,56	3,54	1,59	6,11	3,26	1,87	6,10	2,97	2,10	7,33	3,02	2,43	8,05	3,12	2,57
8.1T	20	8,99	2,43	3,70	10,99	2,88	3,80	14,00	3,55	3,96	15,40	3,74	3,99	15,80	3,56	4,42	16,46	3,44	4,79
	25	11,70	3,59	3,25	13,38	3,88	3,43	15,90	4,32	3,69	17,36	4,80	3,51	17,40	4,47	3,90	17,70	4,37	4,04
	30	11,50	4,46	2,59	13,10	4,72	2,77	15,50	5,11	3,04	17,31	5,42	3,11	17,20	5,05	3,41	17,14	4,82	3,57
	35	11,40	5,42	2,11	14,00	5,60	2,50	15,10	6,00	2,52	16,57	5,90	2,73	16,50	5,60	2,94	16,38	5,22	3,14
	40	8,92	5,11	1,75	9,71	5,02	1,94	10,90	4,89	2,22	10,94	4,57	2,38	11,70	4,42	2,65	12,72	4,58	2,78
	43	5,98	4,50	1,33	6,52	4,35	1,51	7,33	4,12	1,78	8,11	4,04	1,99	9,01	3,91	2,31	9,90	4,04	2,45
9.1	20	15,08	3,66	4,13	16,34	3,59	4,56	18,22	3,48	5,24	18,98	3,33	5,72	18,20	2,82	6,46	18,08	2,49	7,26
	25	17,30	4,34	3,99	18,71	4,31	4,34	20,84	4,27	4,88	20,77	3,97	5,25	20,53	3,43	5,98	20,70	3,01	6,88
	30	17,05	5,28	3,23	18,81	5,36	3,51	21,45	5,46	3,93	22,27	5,32	4,19	23,32	4,91	4,75	22,91	4,20	5,45
	35	16,50	5,90	2,80	17,09	5,98	2,86	20,05	6,24	3,21	21,12	6,16	3,43	22,18	5,72	3,88	21,66	4,89	4,43
	40	13,17	5,98	2,20	15,02	6,20	2,42	17,78	6,53	2,72	18,82	6,48	2,91	20,09	6,14	3,27	19,97	5,40	3,70
	45	11,22	6,15	1,82	12,94	6,42	2,02	15,52	6,81	2,28	16,53	6,79	2,43	18,00	6,56	2,75	18,28	5,90	3,10
10.1	20	17,27	4,48	3,85	18,77	4,43	4,24	21,03	4,35	4,83	21,53	4,12	5,24	21,58	3,68	5,87	23,54	3,61	6,52
	25	19,18	5,18	3,71	20,72	5,18	4,00	23,03	5,18	4,44	23,57	4,98	4,73	24,71	4,63	5,34	24,49	4,03	6,07
	30	20,01	6,45	3,10	21,93	6,60	3,32	24,80	6,82	3,64	25,77	6,72	3,83	26,49	6,12	4,33	27,33	5,49	4,98
	35	18,94	6,61	2,87	21,00	7,12	2,95	23,78	7,89	3,01	24,99	7,90	3,16	25,80	7,21	3,58	26,57	6,41	4,14
	40	16,24	7,48	2,17	18,18	7,72	2,35	21,09	8,08	2,61	22,22	8,04	2,76	23,28	7,43	3,13	20,79	5,78	3,60
	45	14,00	7,81	1,79	15,76	8,00	1,97	18,39	8,28	2,22	19,45	8,18	2,38	20,75	7,64	2,72	18,92	6,08	3,11
12.1	20	20,56	5,69	3,62	22,43	5,66	3,96	25,22	5,62	4,49	26,07	5,39	4,84	26,65	4,95	5,38	27,37	4,61	5,93
	25	25,08	7,24	3,47	27,06	7,29	3,71	30,02	7,36	4,08	31,00	7,18	4,32	32,18	6,65	4,84	33,70	6,18	5,46
	30	25,19	8,43	2,99	27,42	8,68	3,16	30,76	9,07	3,39	32,03	9,06	3,54	33,50	8,41	3,98	33,52	7,30	4,59
	35	23,50	9,14	2,57	26,00	9,63	2,70	29,36	10,33	2,84	30,81	10,50	2,93	32,32	9,72	3,32	29,20	7,49	3,90
	40	19,54	9,11	2,14	21,50	9,37	2,29	24,43	9,76	2,50	25,20	9,58	2,63	27,75	9,23	3,01	20,90	5,96	3,51
	45	14,43	8,18	1,76	15,88	8,24	1,93	18,07	8,34	2,17	18,48	7,97	2,32	20,60	7,67	2,68	18,91	6,05	3,12
14.1	20	21,92	6,52	3,36	25,48	6,85	3,72	30,83	7,35	4,19	30,63	6,81	4,51	30,99	6,22	4,98	32,18	5,90	5,45
	25	28,23	8,66	3,26	30,41	8,76	3,47	33,69	8,91	3,78	34,86	8,77	3,98	36,54	8,25	4,43	35,95	7,24	4,96
	30	29,51	10,21	2,89	31,91	10,59	3,01	35,51	11,17	3,18	35,54	10,84	3,28	38,29	10,38	3,69	33,92	7,95	4,27
	35	29,43	13,70	2,15	29,50	11,57	2,55	30,19	11,21	2,69	32,33	11,81	2,74	35,98	11,59	3,10	31,88	8,65	3,68
	40	20,40	9,63	2,12	22,09	9,87	2,24	24,62	10,23	2,41	25,13	10,01	2,51	27,69	9,59	2,89	21,00	6,15	3,42
	45	15,21	8,74	1,74	16,40	8,68	1,89	18,20	8,60	2,12	18,37	8,10	2,27	20,45	7,71	2,65	18,89	6,02	3,14

kWf: delivered cooling capacity [kW].

kWe: electrical power absorbed [kW].

Tae: outdoor air temperature [°C].

Performance in relation to the difference between inlet and outlet water temperature = 5°C

Note: the data are at maximum operation according to EN 14511:2018

Data for calculation UNI/TS 11300-3

Performance with partial loads in Cooling mode

UNI/TS 11300 - part 3 is the reference standard to be considered for the evaluation of operation of the unit at partial loads in Cooling mode. It indicates the operating temperatures and load factors (100 per cent, 75 per cent, 50 per cent and 25 per cent) to be used, based on the conditions of standard UNI EN 14825.

EER efficiency indices are calculated for each condition for assessing the actual performance of the unit.

Condition	Cooling capacity [kW]				EER			
	1	2	3	4	1	2	3	4
Load factor	100%	75%	50%	25%	100%	75%	50%	25%
Size 2.1	6.14	4.60	3.07	1.53	3.36	4.69	5.55	5.39
Size 3.1	6.39	4.79	3.20	1.60	3.26	4.46	6.13	6.78
Size 4.1	7.94	5.96	3.97	1.99	3.49	4.64	6.45	8.05
Size 5.1	8.67	6.50	4.34	2.17	3.36	4.40	6.81	8.98
Size 6.1	11.16	8.37	5.58	2.79	2.38	3.87	5.56	6.36
Size 7.1	11.72	8.79	5.86	2.93	2.33	3.79	5.62	6.35
Size 8.1	12.88	9.66	6.44	3.22	2.27	3.58	5.11	6.86
Size 6.1T	11.16	8.37	5.58	2.79	2.38	3.87	5.56	6.36
Size 7.1T	11.72	8.79	5.86	2.93	2.33	3.79	5.62	6.35
Size 8.1T	12.88	9.66	6.44	3.22	2.27	3.58	5.11	6.86
Size 9.1	17.09	12.82	8.55	4.27	2.84	4.07	5.42	5.23
Size 10.1	20.87	15.65	10.44	5.22	2.93	3.89	5.21	5.83
Size 12.1	25.84	19.38	12.92	6.46	2.68	3.73	5.03	6.44
Size 14.1	29.74	22.30	14.87	7.43	2.37	3.57	4.91	6.36

Points calculated for fixed capacity systems according to prEN 14825:2018 referred to in UNI TS 11300-3

Reference conditions:

1. inlet/outlet water temperature 12/7 °C, outdoor air temperature 35 °C dry bulb
2. outlet water temperature 7 °C, outdoor air temperature 30 °C dry bulb
3. outlet water temperature 7 °C, outdoor air temperature 25 °C dry bulb
4. outlet water temperature 7 °C, outdoor air temperature 20 °C dry bulb

2.1 to 3.1

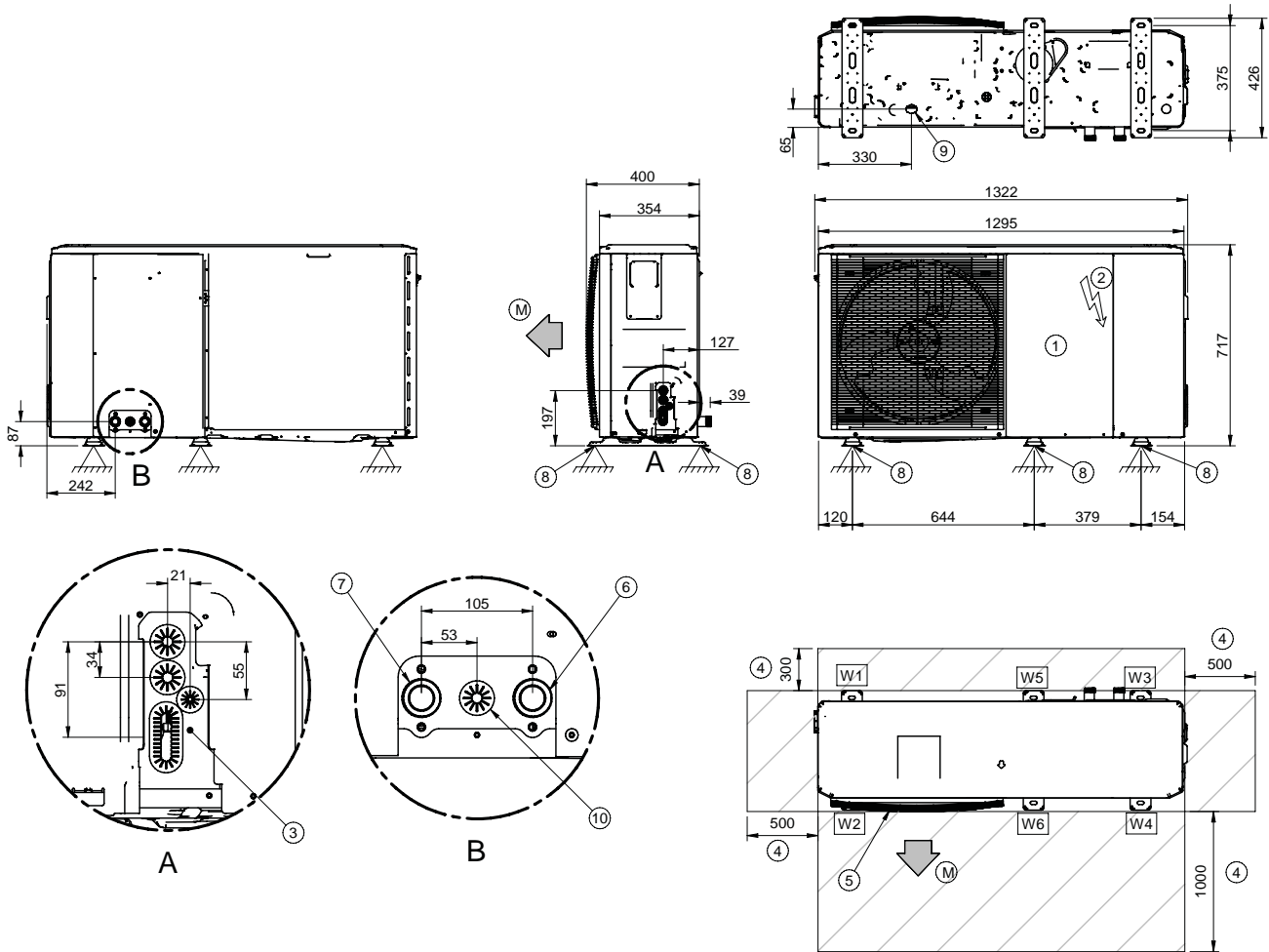

- 1. Refrigeration compartment
- 2. Electrical panel
- 3. Power input
- 4. Functional spaces
- 5. Electric fan (supply and return)
- 6. Water return (ø 1" M)
- 7. Water supply (ø 1" M)
- 8. Supporting point
- 9. Drain hole
- 10. Drain hole for water HP pressure relief valve
- (M) Air supply
- (A) Electrical wiring
- (B) Hydraulic connections

SIZES		2.1	3.1
W1 Supporting point	kg	12	12
W2 Supporting point	kg	12	12
W3 Supporting point	kg	17.2	17.2
W4 Supporting point	kg	14.6	14.6
W5 Supporting point	kg	15.1	15.1
W6 Supporting point	kg	15.1	15.1
Operating weight	kg	86	86
Shipping weight	kg	107	107

Note: the presence of optional accessories may result in significant variation of the weights indicated.

Dimensions, weights and connections

4.1 to 8.1 / 6.1T to 8.1T

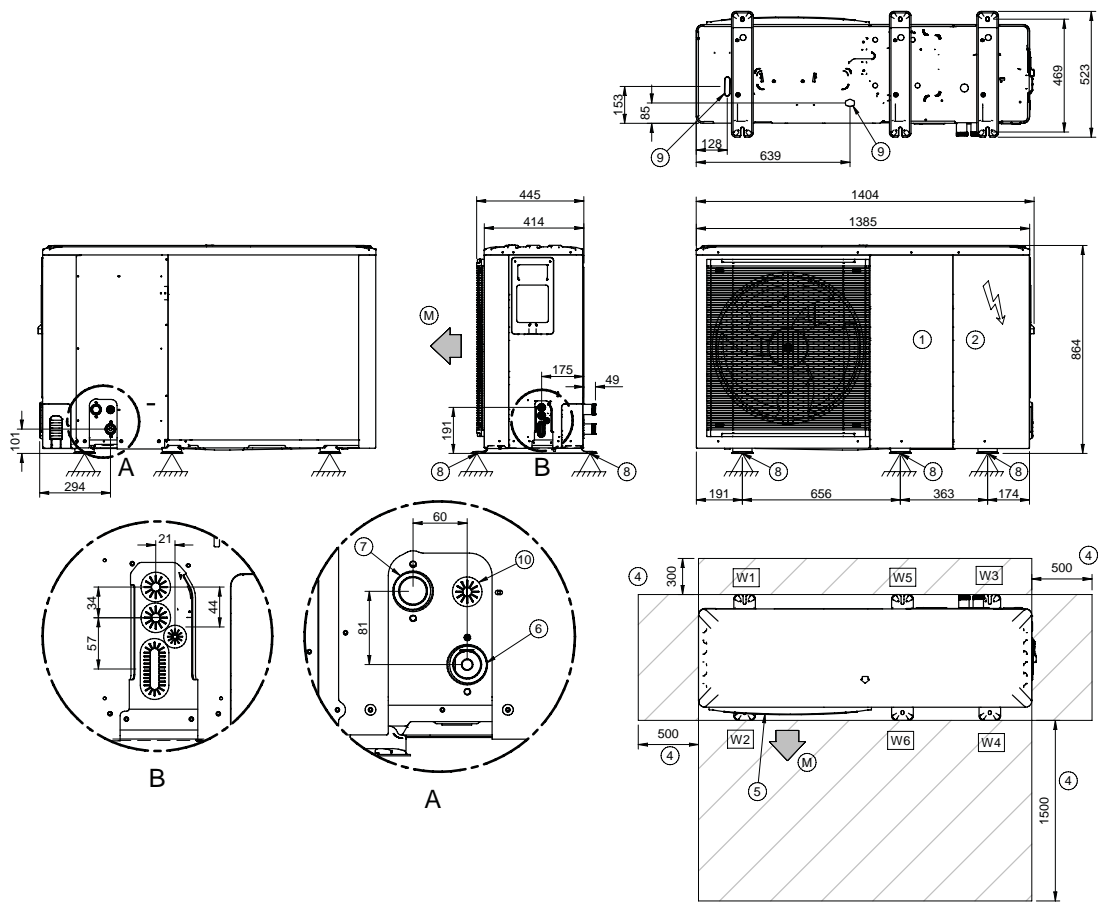

- 1. Refrigeration compartment
- 2. Electrical panel
- 3. Power input
- 4. Functional spaces
- 5. Electric fan (supply and return)
- 6. Water return(Ø 1"1/4 M)
- 7. Water supply(Ø 1"1/4 M)
- 8. Supporting point
- 9. Drain hole
- 10. Drain hole for water HP pressure relief valve
- (M) Air supply
- (A) Electrical wiring
- (B) Hydraulic connections

SIZES		4.1	5.1	6.1	7.1	8.1	6.1T	7.1T	8.1T
W1 Supporting point	kg	14.7	14.7	14.7	14.7	14.7	20.2	20.2	20.2
W2 Supporting point	kg	14.7	14.7	14.7	14.7	14.7	20.2	20.2	20.2
W3 Supporting point	kg	21	21	21	21	21	28.8	28.8	28.8
W4 Supporting point	kg	17.9	17.9	17.9	17.9	17.9	24.5	24.5	24.5
W5 Supporting point	kg	18.4	18.4	18.4	18.4	18.4	25.2	25.2	25.2
W6 Supporting point	kg	18.4	18.4	18.4	18.4	18.4	25.2	25.2	25.2
Operating weight	kg	105	105	129	129	129	144	144	144
Shipping weight	kg	132	132	155	155	155	172	172	172

Note: the presence of optional accessories may result in significant variation of the weights indicated.

9.1 to 14.1

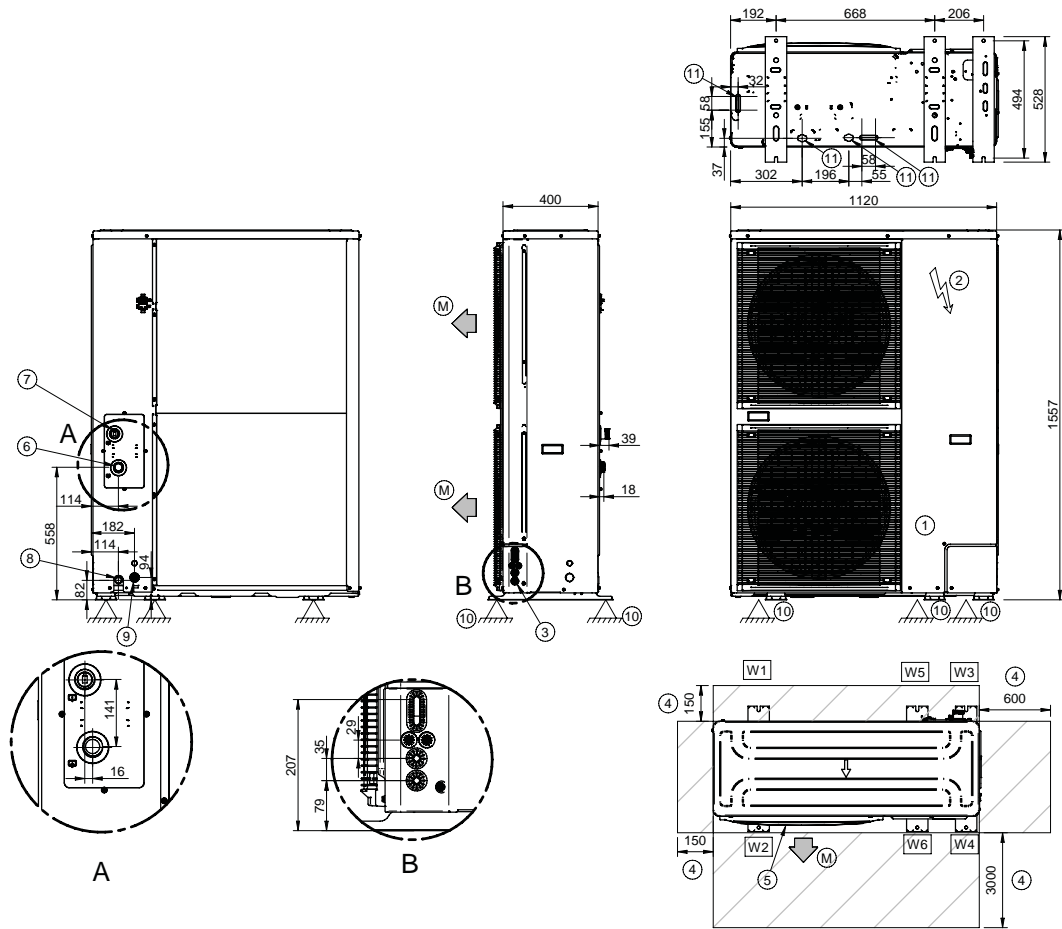

- 1. Refrigeration compartment
- 2. Electrical panel
- 3. Power input
- 4. Functional spaces
- 5. Electric fan (supply and return)
- 6. Water return (Ø 1" 1/4 M)
- 7. Water supply (Ø 1" 1/4 M)
- 8. Water drain hole (Ø 3/4")
- 9. Drain hole for water HP pressure relief valve
- 10. Supporting point
- 11. Drain hole
- (M) Air supply
- (A) Electrical wiring
- (B) Hydraulic connections

SIZES		9.1	10.1	12.1	14.1
W1 Supporting point	kg	26.6	26.6	26.6	26.6
W2 Supporting point	kg	26.6	26.6	26.6	26.6
W3 Supporting point	kg	31.9	31.9	31.9	31.9
W4 Supporting point	kg	30.7	30.7	30.7	30.7
W5 Supporting point	kg	30.7	30.7	30.7	30.7
W6 Supporting point	kg	30.7	30.7	30.7	30.7
Operating weight	kg	177	177	177	177
Shipping weight	kg	206	206	206	206

Note: The presence of optional accessories may result in significant variation of the weights indicated.

Clearances for installation

The clearances must be respected during installation of the unit to ensure ease of maintenance and operation.

✓ Installation of a single unit

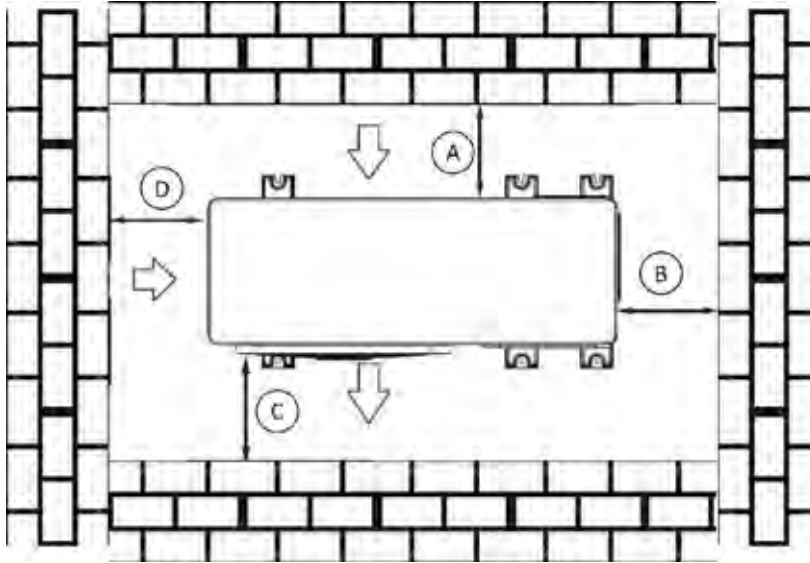

SIZE	2.1 TO 3.1	5.1 TO 8.1	9.1 TO 14.1
A	> 300mm		
B	> 500mm		> 600mm
C	> 1,000mm	> 1,500mm	> 3,000mm
D	> 500mm		> 300mm

✓ Installation in a set

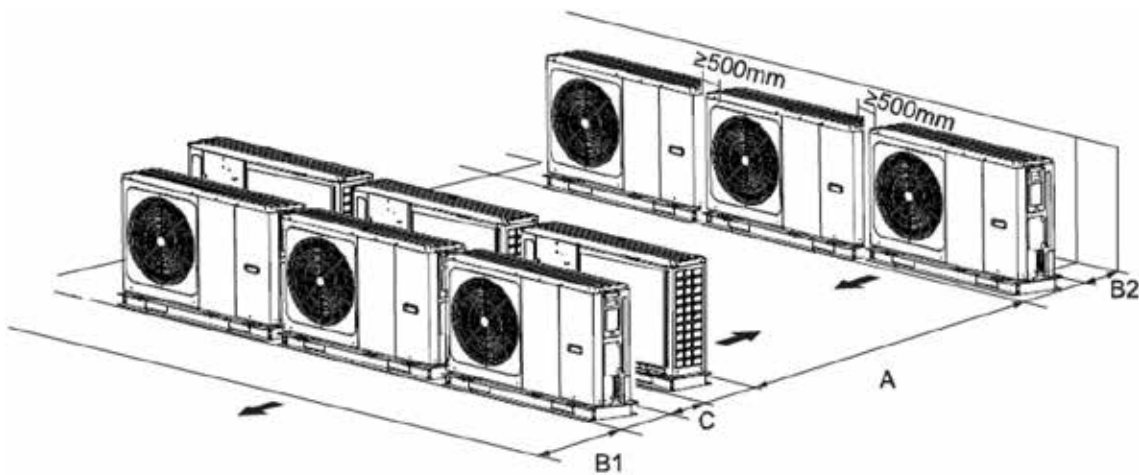

SIZE	2.1 TO 3.1	5.1 TO 8.1	9.1 TO 14.1
A	> 2,500mm	> 3,000mm	> 6,000mm
B1	> 1,000mm	> 1,500mm	> 3,000mm
B2	> 300mm		
C	> 600mm		> 1,000mm

Compatibility of accessories/configurations

Sizes and accessories

SIZE	2.1	3.1	4.1	5.1	6.1	7.1	8.1	6.1T	7.1T	8.1T	9.1	10.1	12.1	14.1
3DHWX	0													
QERAX					o (ACS200X / ACS300X / ACS500X)									-
QERATX										o (ACS1000X / ACS10SX)				
ACS200X							0							-
ACS300X							0							-
ACS500X														-
ACS1000X												0		
ACS10SX												0		
SCS08X					o (ACS200X / ACS300X)									-
SCS12X					o (ACS500X)									-
IBHX							0							-
IBHTX												0		
TANKX		o (30 l)						o (70 l)				o (100 l)		
KTCAX		0												0
DIX							0							-
DI50-2X										0				
DI100X										0				
KTFLX		0												0
PRSX										0				
PCSX							0							-
PCS2X										0				
KCSX										0				-
KIRE2HX							0							-
KIRE2HLX							0							-
VAGX		0								0				0
VDACSX					o (Hybrid version)									
DTX										0				
KSIPX							0							-
AMRX							0							0
ASTFX							0							0
AMMSX		0								0				0
FDMX		0								0				0
T1BX										0				
T1B30X										0				
HID-TCXBX										0				
HID-TCXNX										0				
SWCX										0				

Compatibility of accessories/configurations

Rules of compatibility between accessories

Auxiliary heat sources	IBH IBHX IBHTX	ELFOSun	ACS10SX SCS08X SCS12X	GAS BOILER
IBH / IBHX / IBHTX	-	0	0	NO
ELFOSUN	0	-	0	0
GAS BOILER	NO	0	0	-

Boilers	KCSAFX CCOAX KSDFX	KAS80X	INAILX FH100X	HIDUCX
GAS BOILER_FE	0	NO	NO	NO
GAS BOILER_UC (24.4-33.4)	0	0	NO	NO
GAS BOILER_UC (70.2-115.2)	NO	NO	0	0
GAS BOILER_UC (200F.2)	NO	NO	0	NO

Accessories for installation	DTX	KSIPX	TANKX	VAGX	ASTFX	AMMSX	AMRX
DTX	-	0	0	0	0	NO	NO
KSIPX	0	-	NO	0	0	NO	NO
TANKX	0	NO	-	NO	0	NO	NO
VAGX	0	0	NO	-	0	0	0
ASTFX	0	0	0	0	-	NO	NO
AMMSX	NO	NO	NO	0	NO	-	NO
AMRX	NO	NO	NO	0	NO	NO	-

DHW	T1BX T1B30X	SCS08X	SCS12X	QERAX	QERATX
ACS200X	0	0	NO	0	NO
ACS300X	0	0	NO	0	NO
ACS500X	0	NO	0	0	NO
ACS1000X	0	NO	NO	NO	0
ACS10SX	0	NO	NO	NO	0

Note: the accessories that are not mentioned can be freely selected without issues of compatibility

“Factory made” hybrid configurations

“Factory made” hybrid heat pumps are equipped with a boiler selected to optimise operation of the system.

System Management

The heat pump manages the boiler depending on the temperature detected by the T1 probe, which is included in the boiler kit and must be installed in the field. The boiler must be enabled at the unit's HMI and can be managed with a simple ON/OFF potential-free contact, in which case it is necessary to set the required set-points directly at the boiler interface, or in combination with a 0-10V signal that adjusts and determines the set-point dynamically.

Stand-alone systems

Compared to a traditional third-party boiler, the “Factory made” stand-alone hybrid is designed to produce system water at higher temperatures than the heat pump alone, and to operate simultaneously in system and DHW mode.

The boilers are available in two versions, each of which can operate with Natural Gas (G20) or LPG (G30-G31) by adjusting or applying a reducer to the nozzle on site. The FE version can also work with propane air (G230) as standard, and can self-adjust to work with mixtures of natural gas and hydrogen (80%/20%).

- **Gas Boiler UC 24.4-33.4**

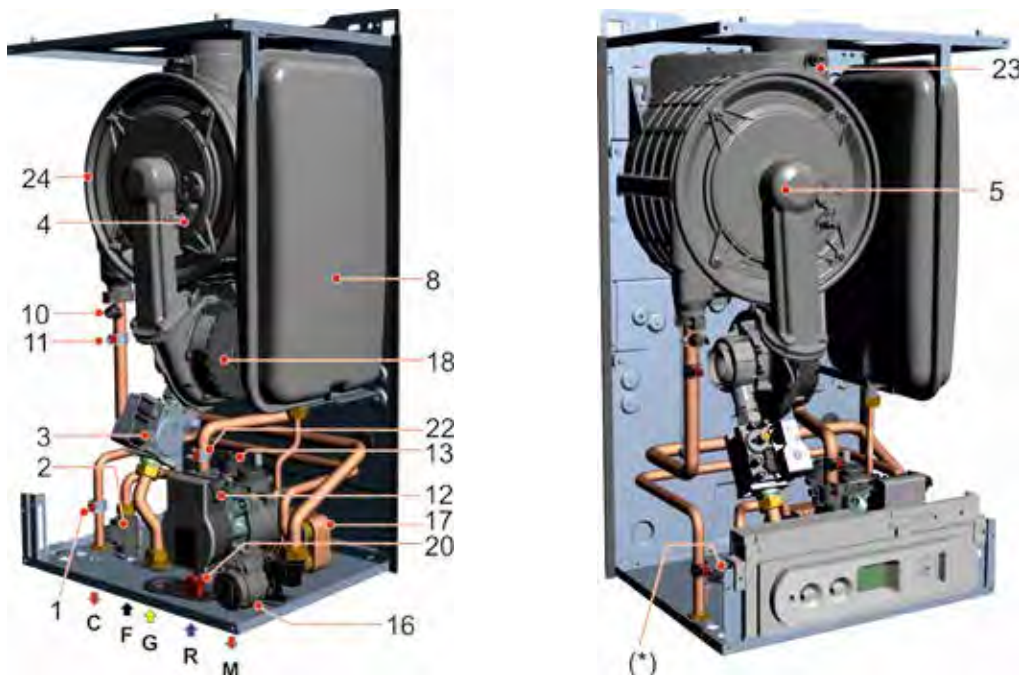

#	NAME	DESCRIPTION
1	SS	Water temperature sensor for DHW
2	FLS	Flow switch with cold water filter
3	VG	Gas valve
4	E.ACC/RIL	Ignition/detection electrode
5	-	Burner
8	-	Expansion vessel
10	TL	Safety thermostat
11	SR	Water temperature sensor - Heating supply
12	P	Circulator
13	DK	Low water control pressure switch
16	-	Switching valve
17	-	DHW plate exchanger
18	VM	Fan
20	-	Pressure relief valve
22	SRR	Water temperature sensor - return
23	TLC	Flue gas manifold safety thermostat
24	-	Steel exchanger/condenser
(*)	-	Condensate drain trap outlet position

Dimensions

GAS BOILER UC

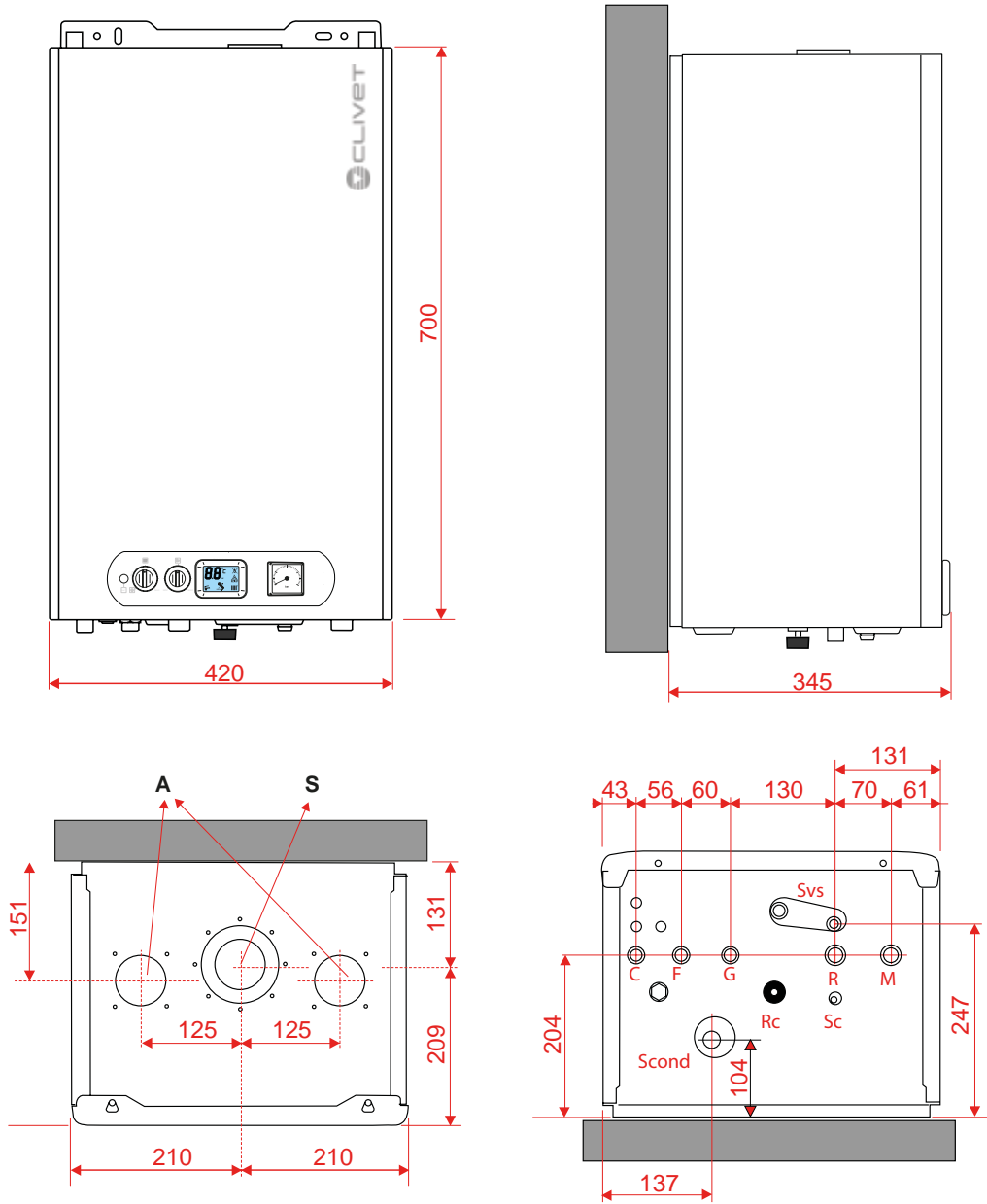

- M = Ø 3/4" system supply
- R = Ø 3/4" system return
- G = Ø 3/4" gas
- F = Ø 1/2" cold domestic water inlet
- C = Ø 1/2" hot domestic water outlet
- SC = Condensate drain (Ø 18.1)
- A = Ø 80 air intake
- S = Ø 80 flue gas drain

• Gas Boiler FE 24.4-33.4

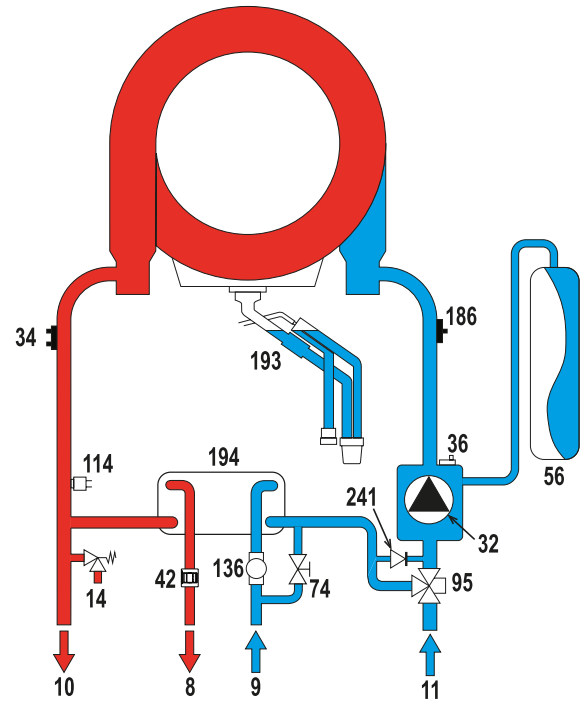
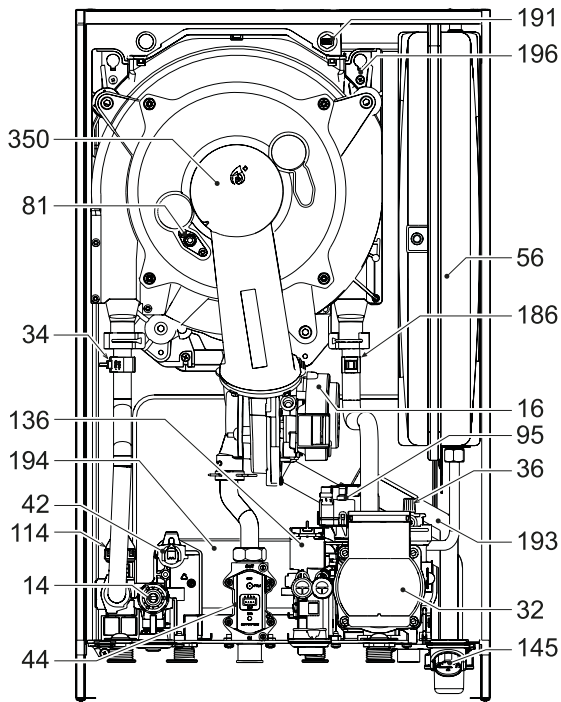

#	DESCRIPTION
14	Pressure relief valve
16	Fan
32	Circulator
34	Water temperature sensor - Heating supply
36	Automatic air vent
42	Water temperature sensor for DHW
44	Gas valve
56	Expansion vessel
74	System filling tap
81	Ignition/detection electrode
95	Switching valve
114	Water pressure switch
136	Flowmeter
145	Hydrometer
186	Water temperature sensor - return
191	Flue gas temperature sensor
193	Siphon
194	DHW plate exchanger
196	Drain pan
241	Automatic bypass (inside the pump unit)
350	Burner / fan unit

Boiler dimensions

GAS BOILER FE 24.4

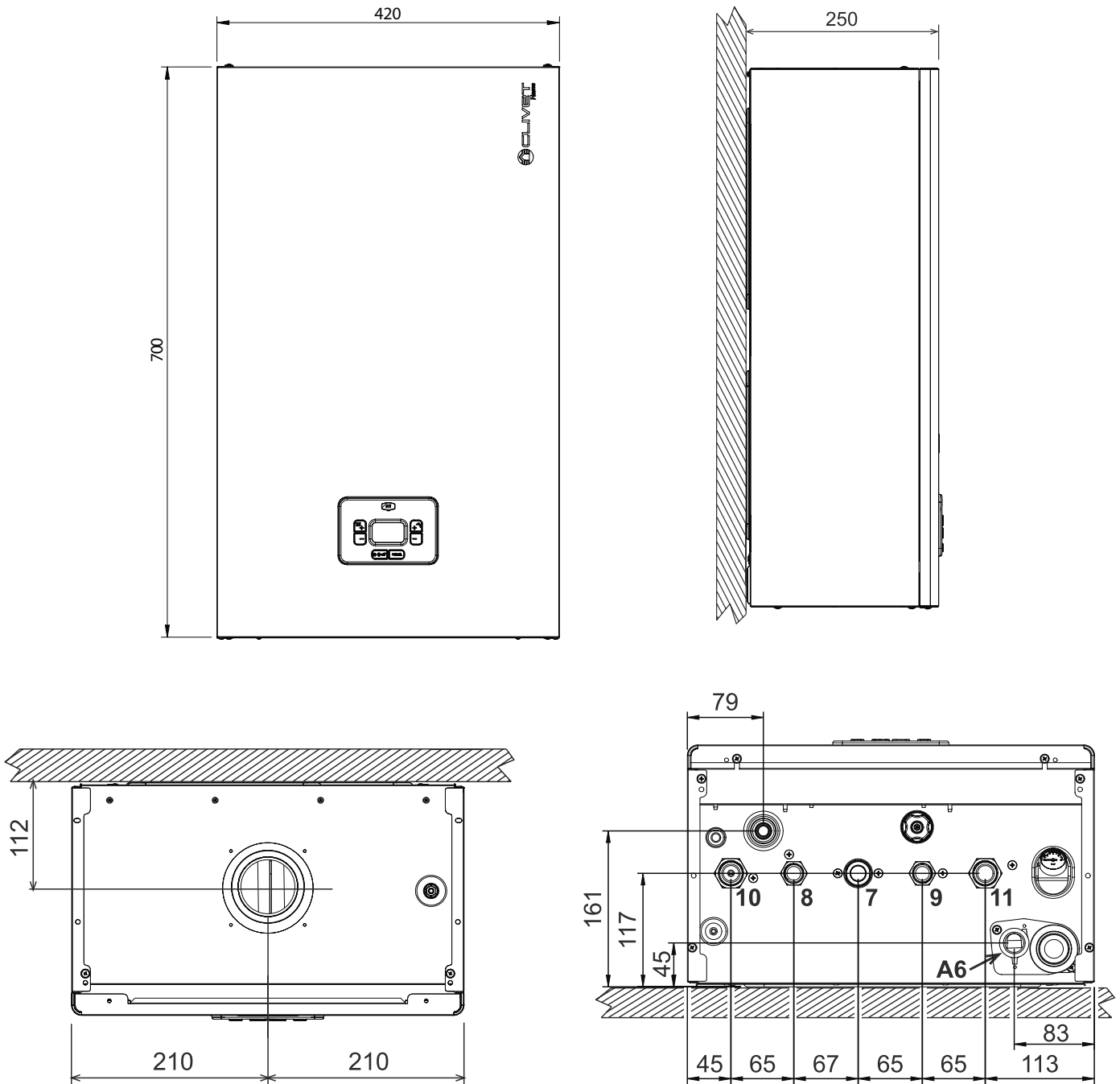

- 10 = Ø 3/4" system supply
- 11 = Ø 3/4" system return
- 7 = Ø 3/4" gas
- 9 = Ø 1/2" cold domestic water inlet
- 8 = Ø 1/2" hot domestic water outlet
- A6 = Condensate drain (Ø 22.5)
- Ø 80 air intake and flue gas drain

GAS BOILER FE 33.4

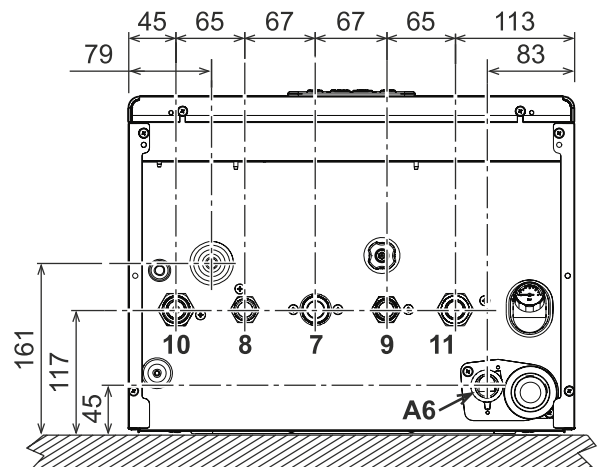
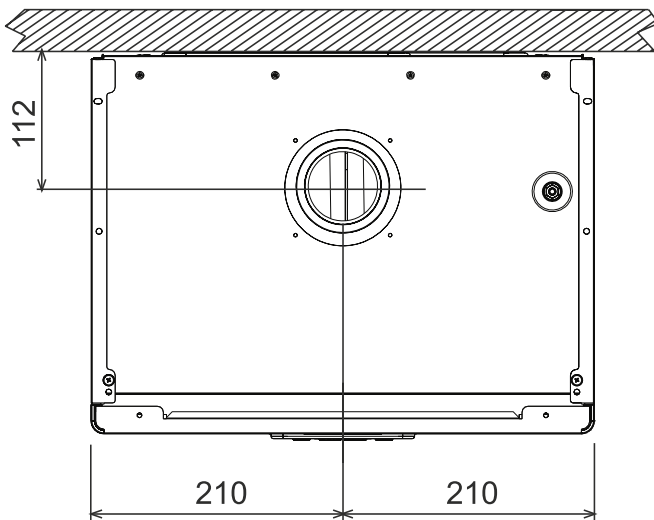
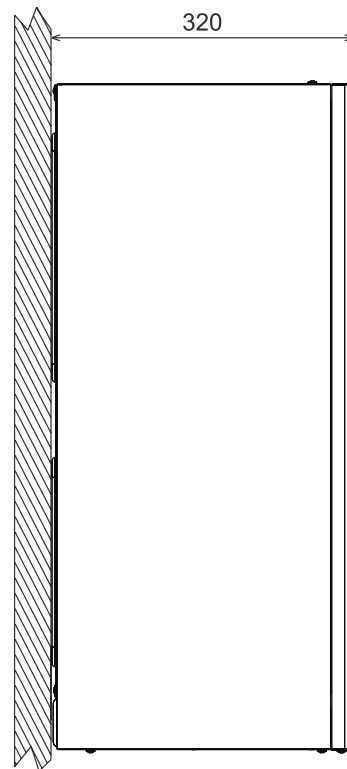
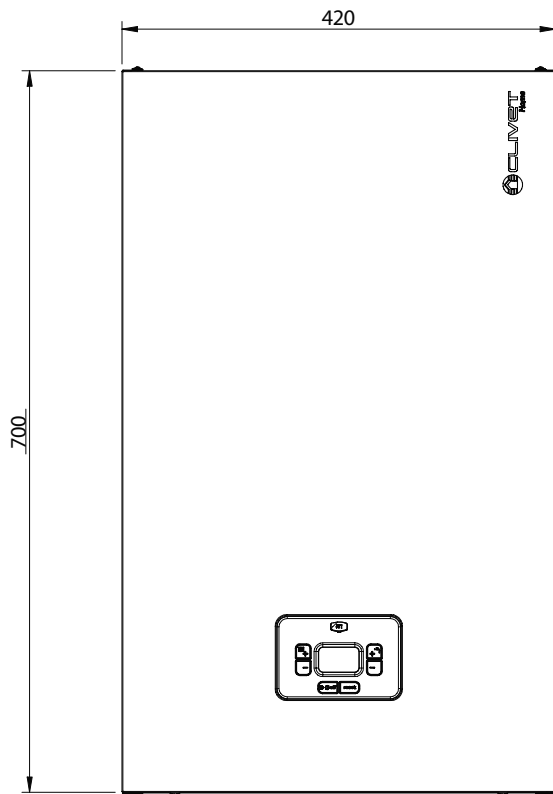

- 10 = Ø 3/4" system supply
- 11 = Ø 3/4" system return
- 7 = Ø 3/4" gas
- 9 = Ø 1/2" cold domestic water inlet
- 8 = Ø 1/2" hot domestic water outlet
- A6 = Condensate drain (Ø 22.5)
- Ø 80 air intake and flue gas drain

Accessories and configurations: technical details

Operation (hybrids with boilers for stand-alone systems)

In case of DHW demand, the unit can operate in system mode and the boiler in DHW mode, ensuring simultaneous operation in both modes. In this case, operation is:

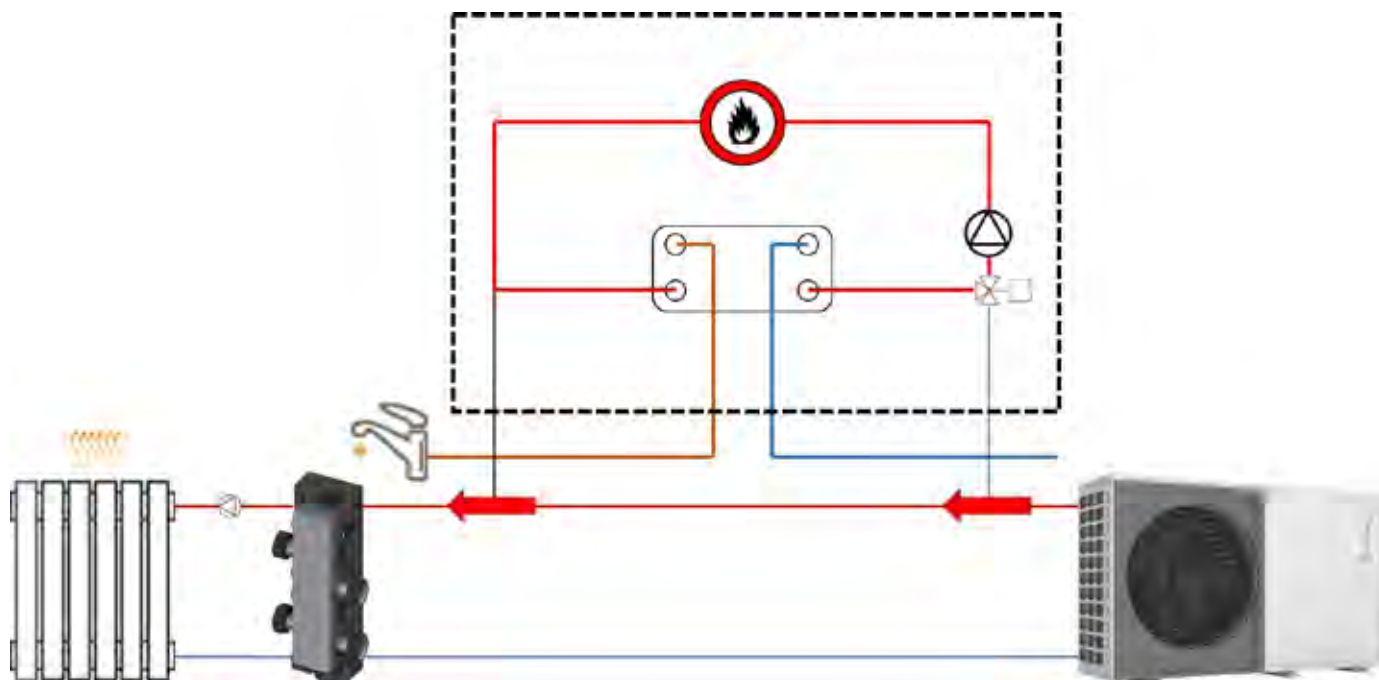

The boiler can be used to increase the system's water temperature up to 75 °C, or as a back-up in case of very cold outdoor temperatures or breakdown. In this case, operation is:

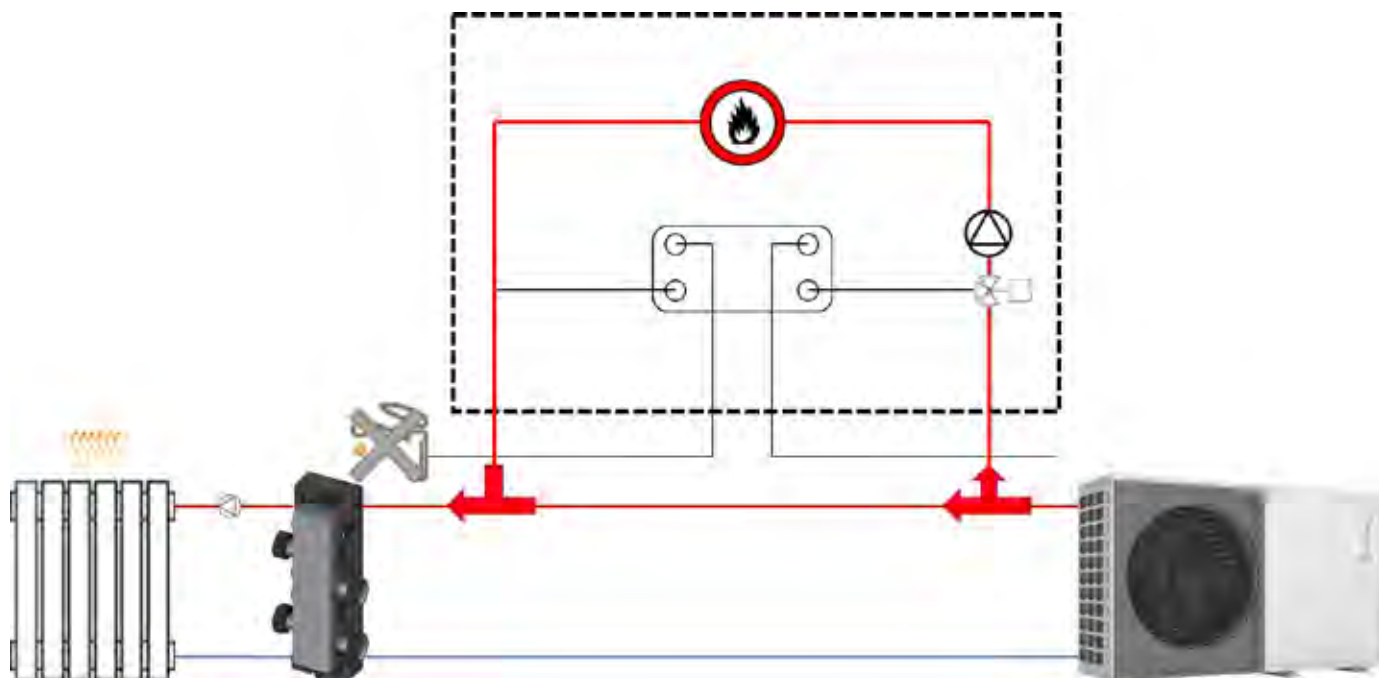

Flue accessories (boilers for stand-alone systems)

Boilers for "Factory made" hybrid versions are type C with sealed chamber and forced draught: they require air inlet and flue gas outlet connected with ducts made with coaxial or separate pipes and with independent or shared flues.

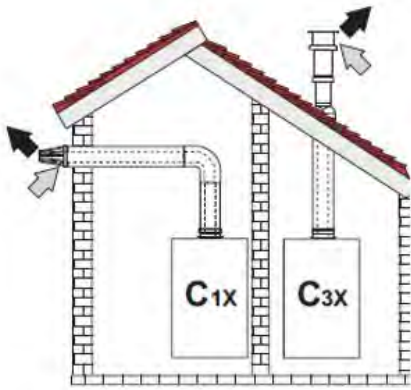

example of connection
with coaxial pipes

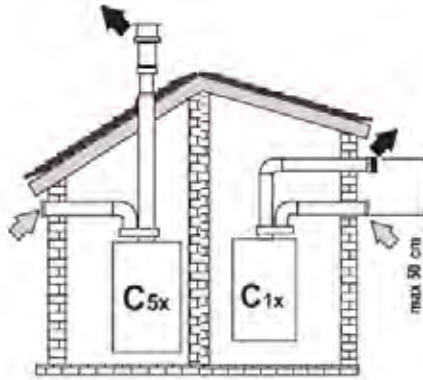

example of connection
with separate pipes

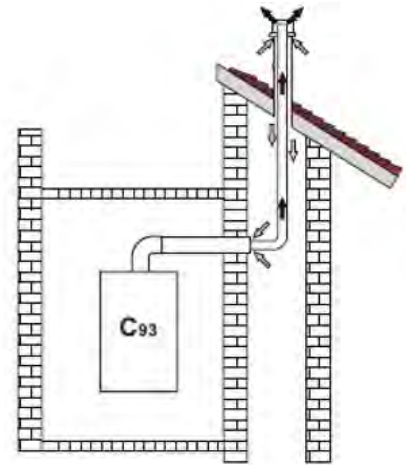

example of connection to
collective flues

Note: refer to the manual for further details on installations

Each boiler is compatible with dedicated flue accessories, allowing for the most common installations:

- **KCSAFX = \varnothing 60/100 mm vertical coaxial fitting**

Vertical coaxial flanged polypropylene fitting, measuring 60/100 mm in diameter, for the discharge of gas and intake of air for combustion via two coaxial ducts

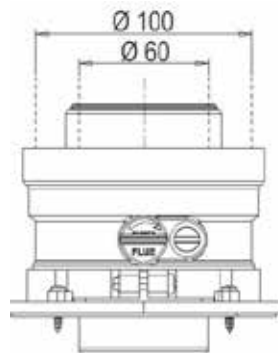

- **CCOAX = 90° coaxial elbow for \varnothing 60/100 mm horizontal outlet that can be adjusted at 360°**
- **TCOAX = L = 1000mm \varnothing 60/100 coaxial pipe with terminal**

Kit for flue gas discharge and air intake through an external wall, with a 100 cm long coaxial pipe. The internal section is used for the discharge of the combustion gas while the external section is used for the intake of combustion air.

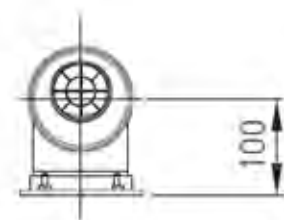
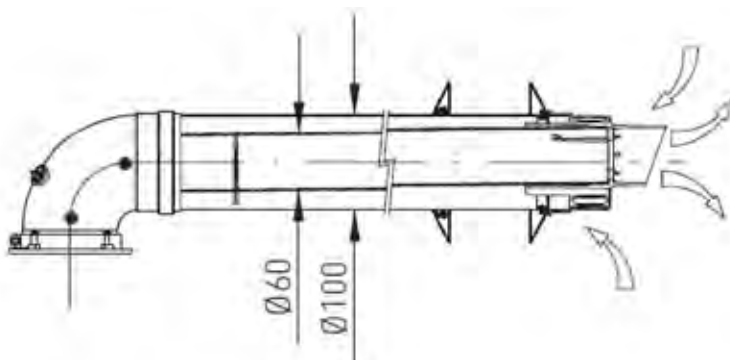

Accessories and configurations: technical details

- KAS80X = \varnothing 80 mm vertical fittings**

Two vertical flanged polypropylene fittings, 80mm diameter, with inspection ports, which allow the combustion gas discharge and air intake to be split directly from the boiler body

Note: only compatible with GAS BOILER UC

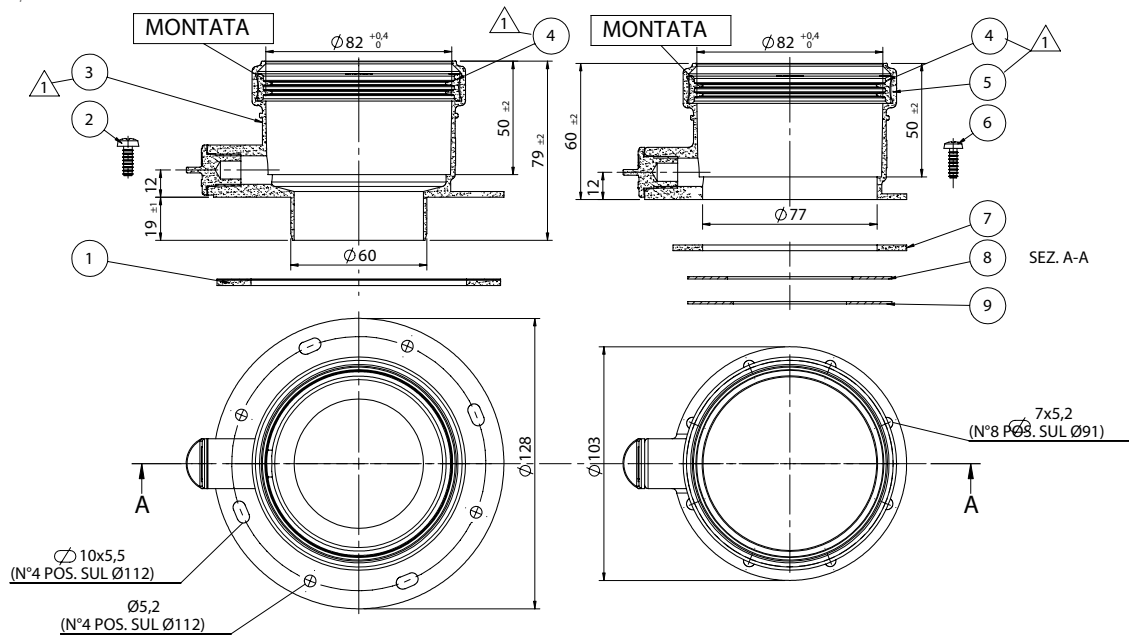

- KSDFX = \varnothing 80 mm flue gas splitter kit**

Polypropylene kit to split the air intake and the flue gas discharge into two 80 mm connections with inspection ports to connect to vertical or bent pipes

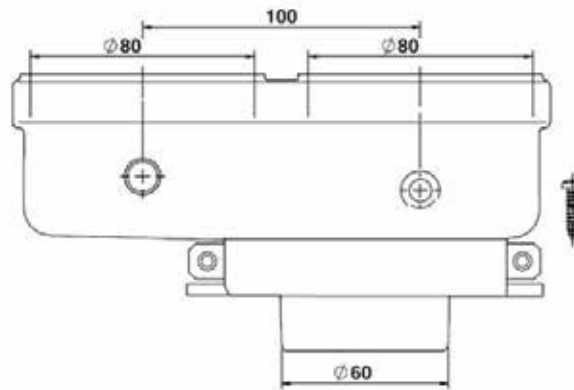

- VDACSX = Thermostatic switching valve for domestic water**

The valve optimises operation of the hybrid heat pump when the boiler is connected downstream of a DHW boiler: when the water is hot enough, it bypasses the boiler to go directly to the user.

Note: use of the valve allows for a higher flow rate at the same pressure in the DHW boiler

Centralized systems

The boilers available are for heating only and can be made to operate with Natural Gas (G20-G25) or LPG (G30-G31) by adjusting or applying a reducer to the nozzle on site.

- **Gas Boiler UC 70.2**

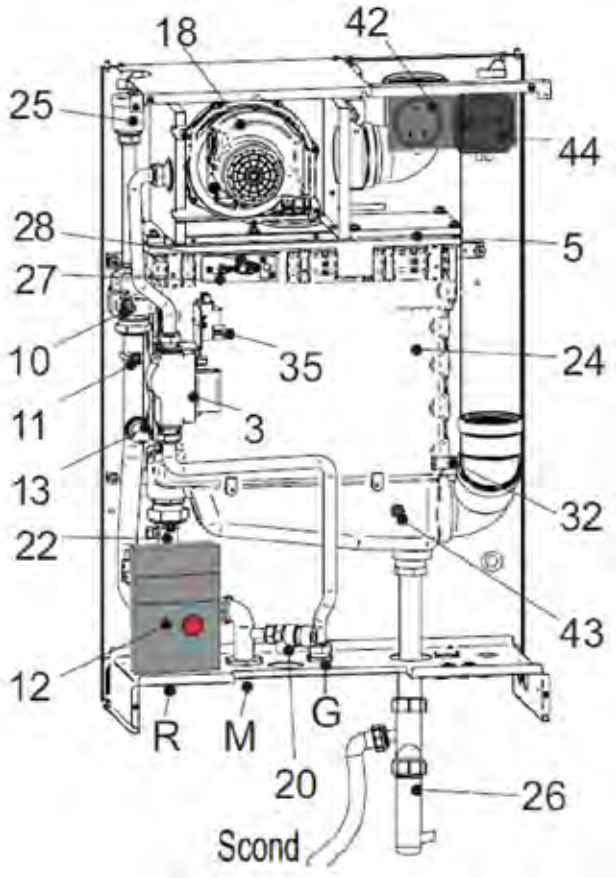

#	DESCRIPTION
3	Gas valve
5	Burner
10	Safety thermostat
11	Water temperature sensor - supply
12	Modulating circulator
13	Low water pressure switch
18	Modulating fan
20	Pressure relief valve
22	Water temperature sensor - return
24	Aluminium exchanger / condenser
25	Vent valve
26	Condensate drain trap
27	Detection electrode
28	Ignition electrode
32	Flue gas inspection point
35	Ignition transformer
42	Flue gas maximum pressure switch
43	Condensate level sensor
44	Flue gas minimum pressure switch

Accessories and configurations: technical details

- Gas Boiler UC 115.2

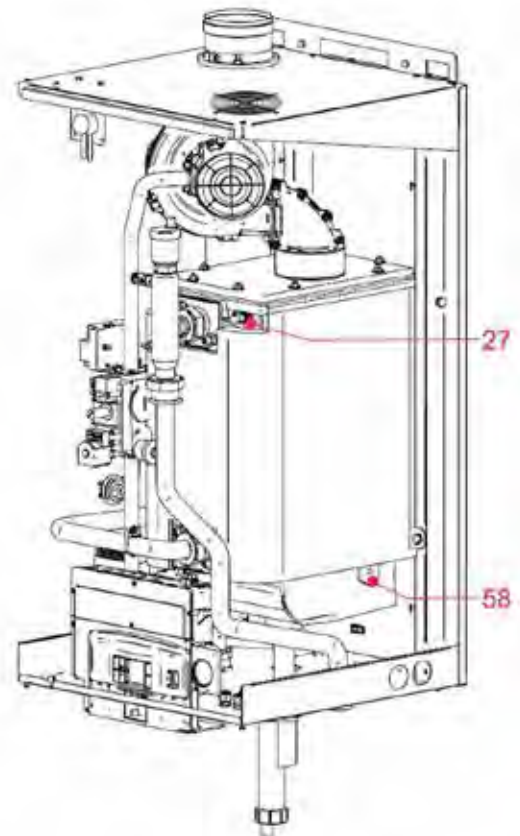
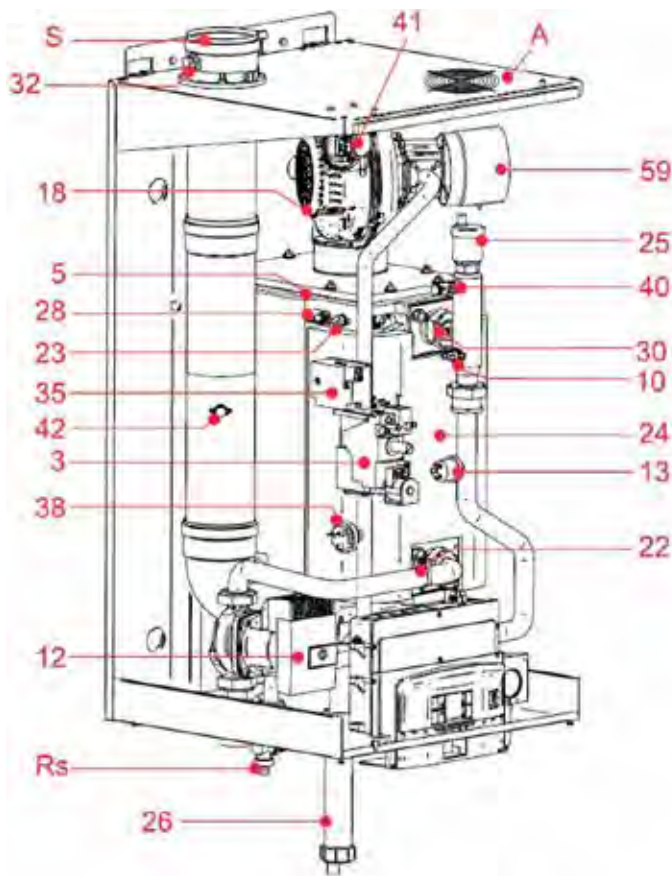

#	DESCRIPTION
3	Gas valve
5	Burner
10	Safety thermostat
12	Modulating circulator
13	Low water pressure switch
18	Modulating fan
22	Water temperature sensor - return
23	Unit body safety thermostat
24	Aluminium exchanger / condenser
25	Vent valve
26	Condensate drain trap
27	Detection electrode
28	Ignition electrode
30	Water temperature sensor - supply
32	Flue gas inspection point
35	Ignition transformer
38	Flue gas minimum pressure switch
40	Manual vent valve
41	Fan pressure switch
42	Flue thermostat
58	Level sensor
59	Pipe with intake grille

- Gas Boiler UC 200F.2

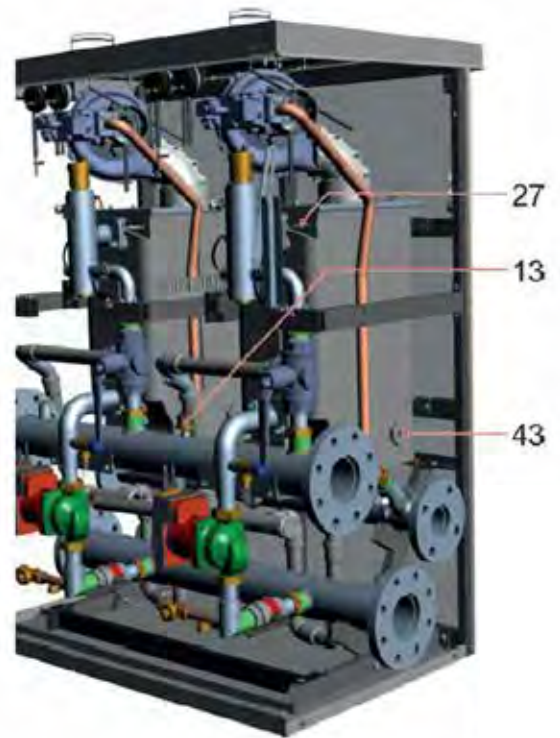
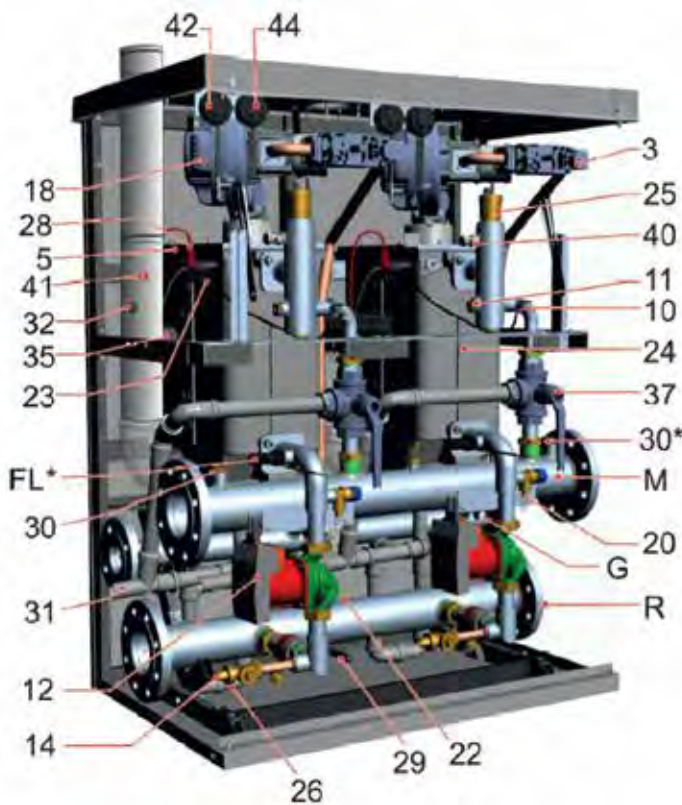

#	DESCRIPTION
3	Gas valve
5	Burner
10	Safety thermostat
11	Heating temperature sensor
12	Modulating circulator
13	Low water pressure switch
14	Drain valve
18	Modulating fan
20	Pressure relief valve
22	Water temperature sensor - return
23	Unit body safety thermostat
24	Aluminium exchanger / condenser
25	Vent valve
26	Condensate drain trap
27	Detection electrode

#	DESCRIPTION
28	Ignition electrode
29	3-way shut-off valve - return
30/30*	Water temperature sensor - supply <i>Probe can be positioned in 30*</i>
31	Condensate drain
32	Flue gas inspection point
35	Ignition transformer
37	3-way shut-off valve - supply
38	Gas minimum pressure switch
40	Manual vent valve
41	Flue thermostat
42	Flue gas maximum pressure switch
43	Condensate level sensor
44	Flue gas minimum pressure switch
FL*	Vane flow switch

Gas Boiler UC 70.2

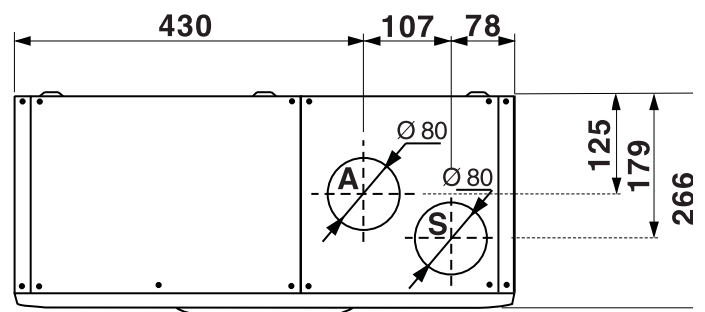
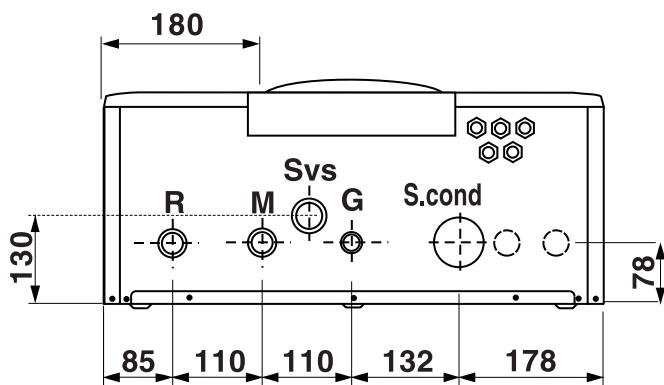
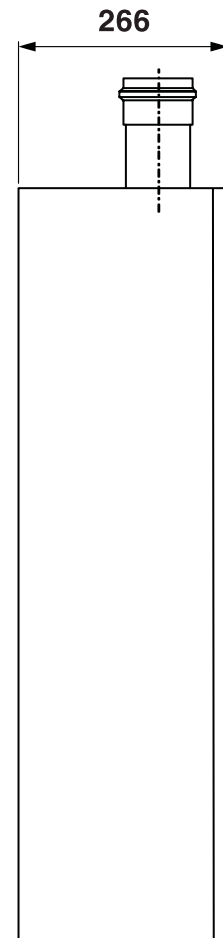
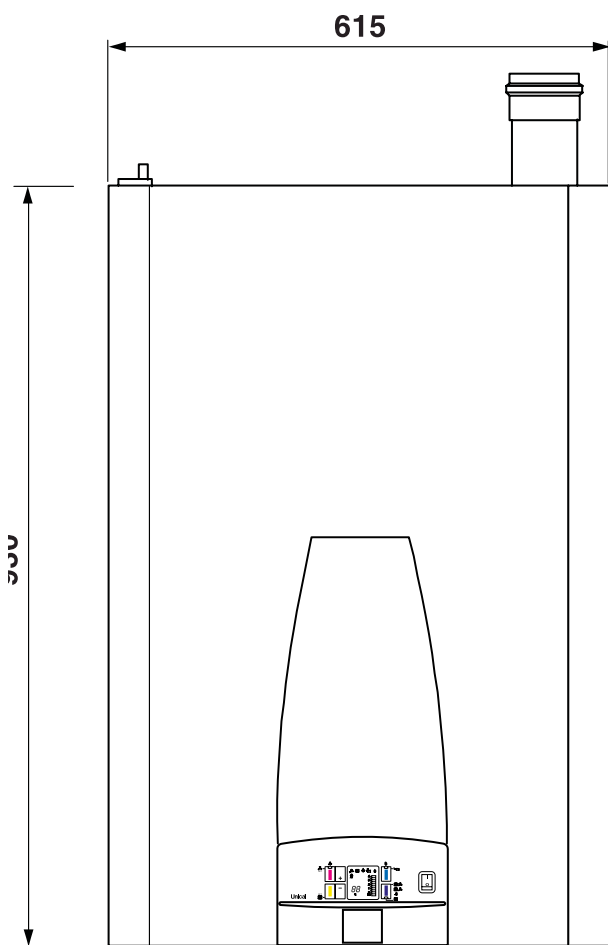

- R = Ø 1/4" heating system return
- M = Ø 1/4" heating system supply
- G = Ø 3/4" gas inlet
- Scond = Ø 18.1 mm condensate drain
- A = Ø 80 mm air intake
- S = Ø 80 mm flue gas drain
- Svs = pressure relief valve

Gas Boiler UC 115.2

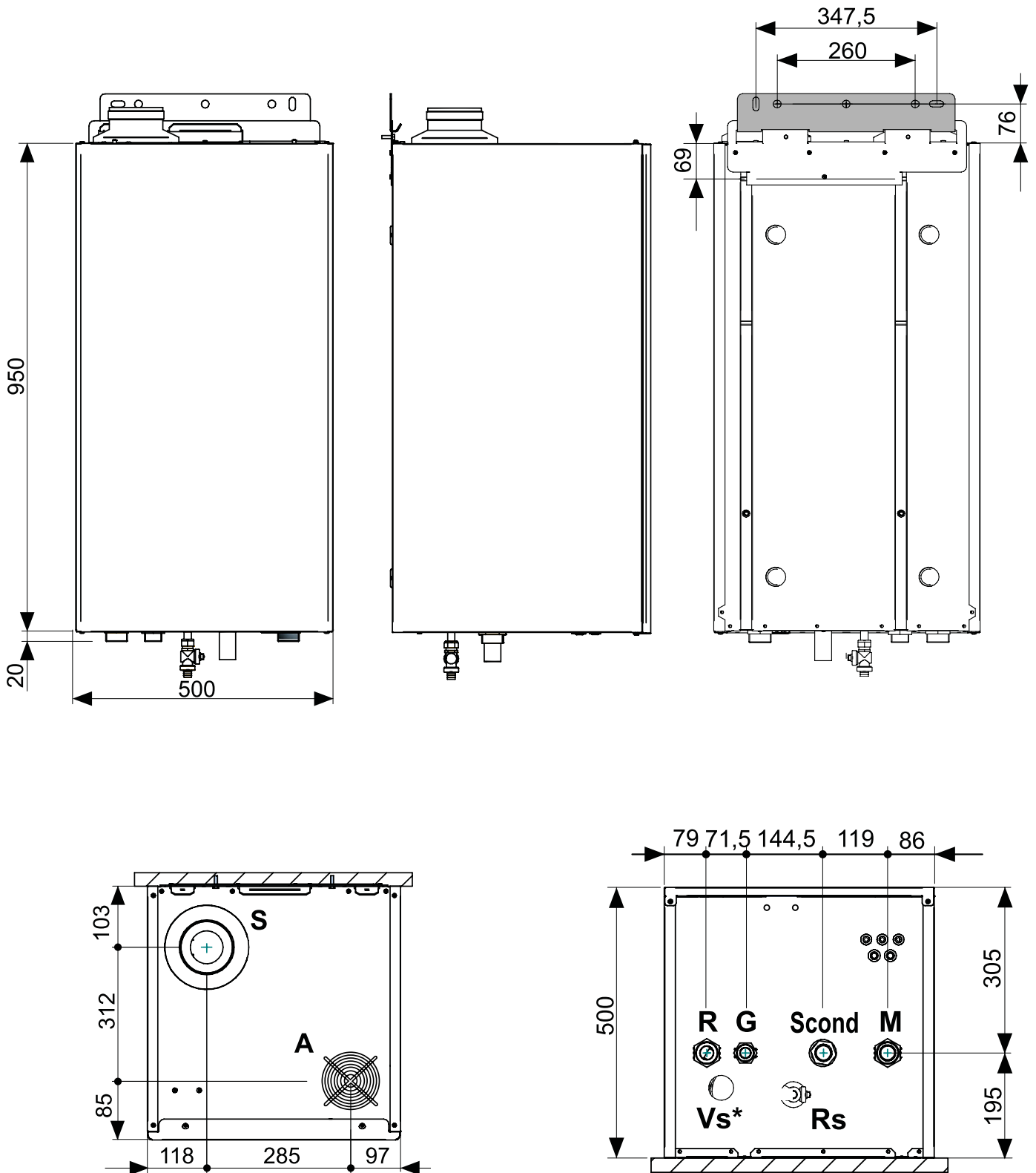

- R = Ø 1" 1/4 heating system return
- M = Ø 1" 1/4 heating system supply
- G = Ø 1" gas inlet
- Scond = Ø 32 mm condensate drain
- A = Ø 80 mm air intake (Ø 100 mm grille)
- S = Ø 100 mm flue gas drain
- Vs = pressure relief valve
- Rs = drain valve

Accessories and configurations: technical details

Gas Boiler UC 200F.2

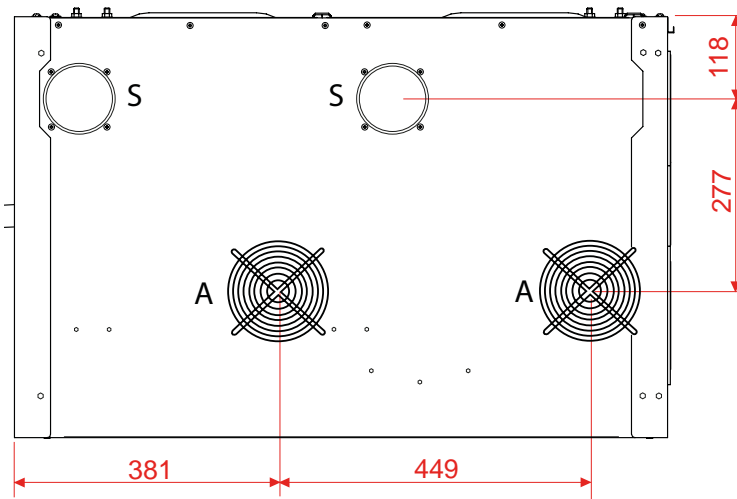
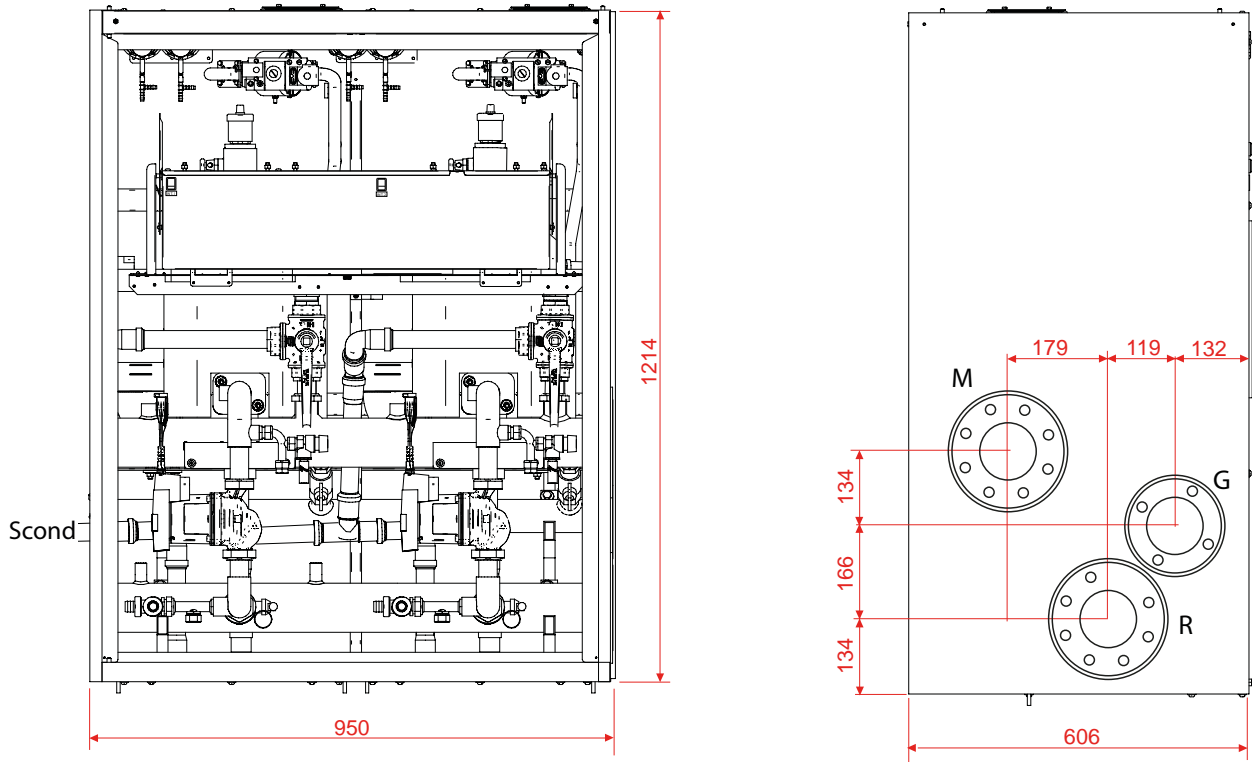

- R = Ø 88.9 mm heating system return manifold
- M = Ø 88.9 mm heating system supply manifold
- G = Ø 60.3 mm gas inlet manifold
- Scond = Ø 32 mm condensate drain
- A = Ø 80 mm air intake (Ø 100 mm grille)
- S = Ø 100 mm flue gas drain

Configuration with integrated electric heater

The unit in IBH configuration has an integrated electric heater on board the unit and has a connected T1 control probe already set up for optimal operation:

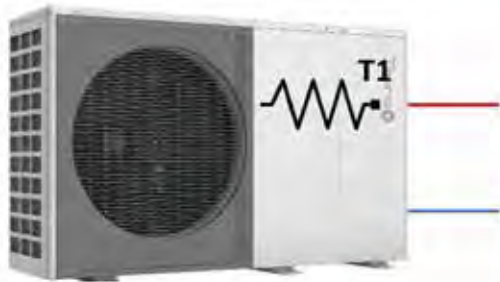

Unit	IBH heater
2.1 TO 8.1	3kW / 1-phase
6.1T TO 8.1T	9kW (3kW+6kW) / 3-phase
9.1 TO 14.1	-

The 9 kW heater version for three-phase units is equipped with one 3 kW and one 6 kW heater
One of three situations can be set during installation at the board of the unit:

- 3 kW in Heating and DHW mode
- 6 kW for heating and DHW
- 9 kW in Heating mode and 6 kW in DHW mode

In the latter case, only the 3 kW heater is switched on when heating is requested.

If the temperature does not rise sufficiently within a certain time, it is switched off and replaced by the 6 kW heater.

If again the temperature does not rise sufficiently within a certain time, the 3kW heater is also activated at the same time, so that a total of 9kW is provided for heating.

Magnetic dirt separator filter for water distribution systems

The filter supplied as standard with the unit is a mesh filter, but it is advisable to install a dirt separator filter (FDMX accessory) to trap not only general dirt, but also fine ferromagnetic particles dispersed during use that are not trapped by the mesh filter.

The dirt separator filter has two main components:

- cyclone-effect filter, which slows down and makes solid particles and impurities settle more easily
- removable ferromagnetic cartridge (magnet) that separates and captures ferrous impurities

The retained impurities are collected in the lower part of the filter (sump), which must be periodically opened and emptied (routine cleaning can also be done while the system is running).

The filter can be used in systems with water or water with glycol (max. 30%), maximum operating pressure 3 bar and temperatures 0 to 90 °C.

Note: The model available for sizes 2.1 to 8.1 has transparent material on the bottom that allows the filter cleaning status to be visually checked.

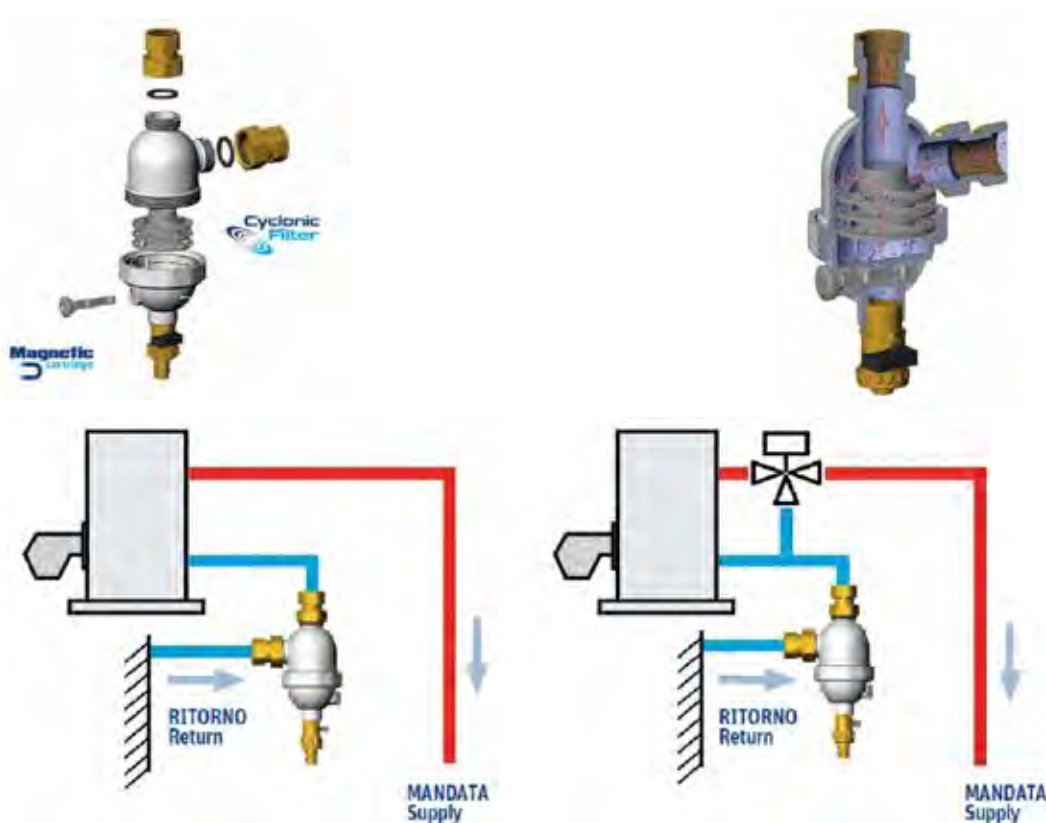

Accessories and configurations: technical details

DHW: boilers, TBH supply kits and solar coils

The unit can be connected to a specially sized DHW boiler: 200, 300, 500 or 1,000 litre accessories are available

			ACS200X	ACS300X	ACS500X	ACS1000X
Performance	Net water volume	l	196	273	475	930
	Energy efficiency class	-		B		C
	Maximum water temperature	°C			95	
	Insulation: material / average thickness	-/mm		PU / 70		PE / 100
	Heat loss	W/K	1.13	1.40	1.78	3.16
	Electric heater	kW		2 / 1-phase		4.5 / 3-phase
Coil	Surface	m ²	1.5	1.8	2.2	3.5
	Internal volume	l	8.6	10.4	12.7	21.0
Maximum operating pressure		bar				10

Data according to DIN 4708 / EN 12897 / EN 15332

PU = polyurethane / PE = polyester fibre

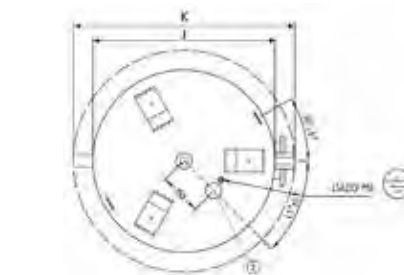
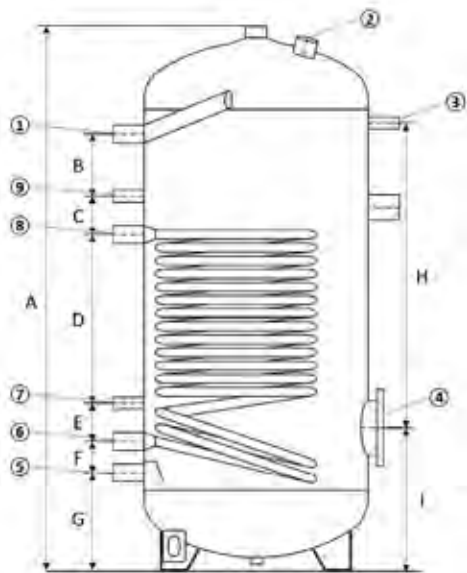

ACS200X/ACS300X/ACS500X

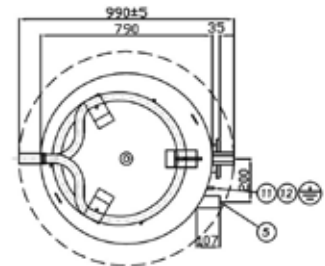
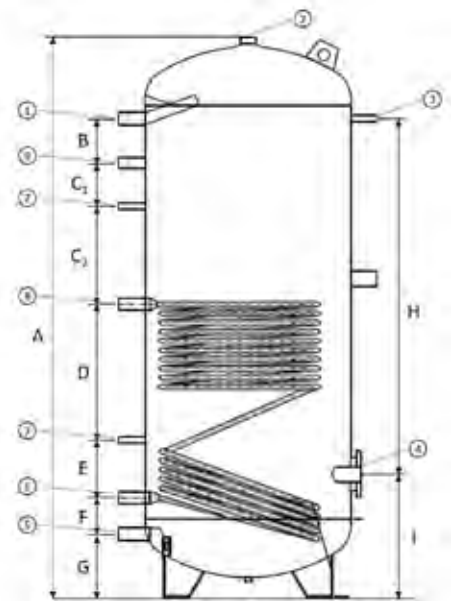

ACS1000X

Accessories and configurations: technical details

[MM]	ACS200X	ACS300X	ACS500X	ACS1000X
A	1.215	1.615	1.705	2.140
B	140	225	245	170
C	85	275	290	-
C1		-		165
C2		-		375
D	375	515	440	520
E	85		95	220
F	70		80	140
G	220		265	240
H	680	1.070	1.060	1.370
I	320		365	470
J	500		650	-
K	640		790	-
Weight	77kg	98kg	128kg	224kg

		ACS200/300/500X	ACS1000X
1	DHW supply	1"1/4	1"1/4
2	Anode	1"1/4	1"1/2
3	Temperature probe	1/2"	
4	Electric heater	1"1/2	
5	Cold water inlet	1"	1"1/4
6	Exchanger return	1"	1"1/4
7	Temperature probe	1/2"	
8	Exchanger supply	1"	1"1/4
9	Recirculation	1/2"	1"

Installation should be carried out bearing the inspection spaces in mind:

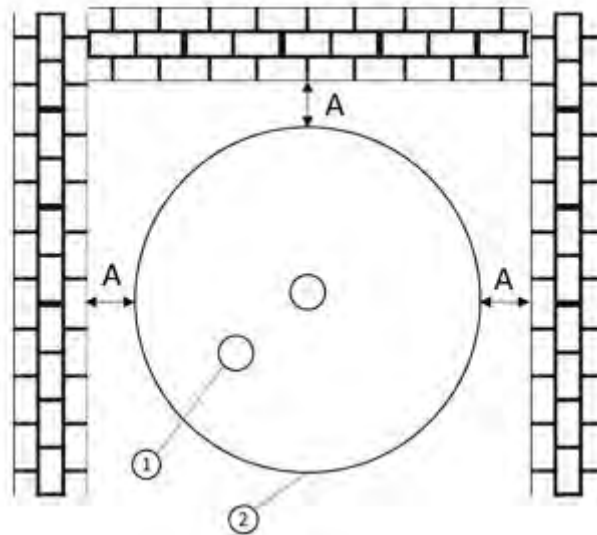

- 1. anode
- 2. electric heater

- A. >50mm

Hydraulic connections:

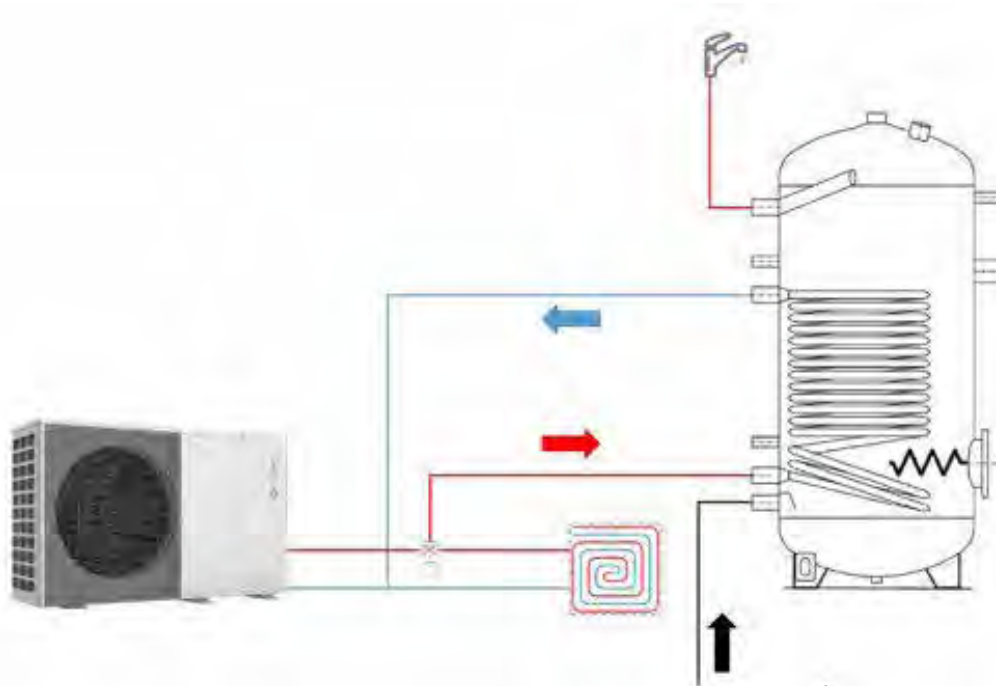

Note: control requires installation of the optional T5 temperature probe

Accessories and configurations: technical details

The dedicated accessory (QERAX for ACS200/300/500X, QERATX for ACS1000X) must be used to power the electric heater of the boiler. The electrical connections are as shown:

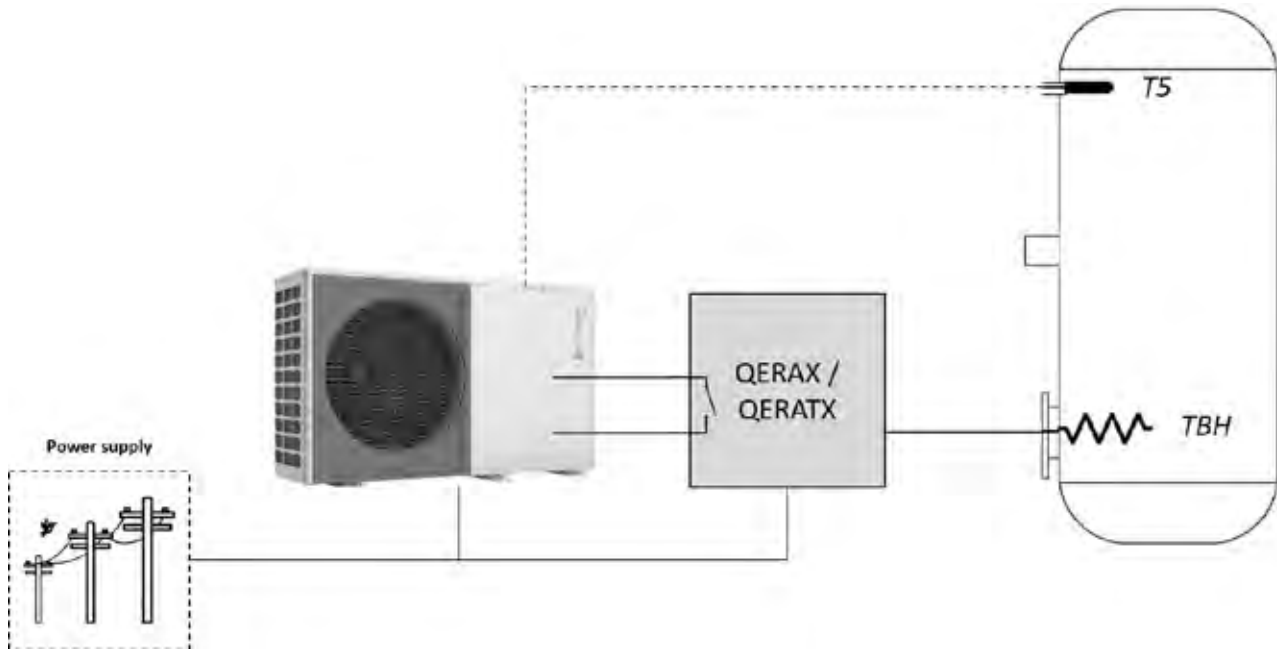

The power transmitted from the coil to the boiler can be calculated using the formula:

$$P_A = (T_I - T_A) \times K_S \quad [\text{W}] \quad \text{where:}$$

T_I : heat exchanger inlet temperature

T_A : average temperature of the boiler

K_S : specific yield coefficient as a function of T_I , obtainable from the diagrams:

ACS200X

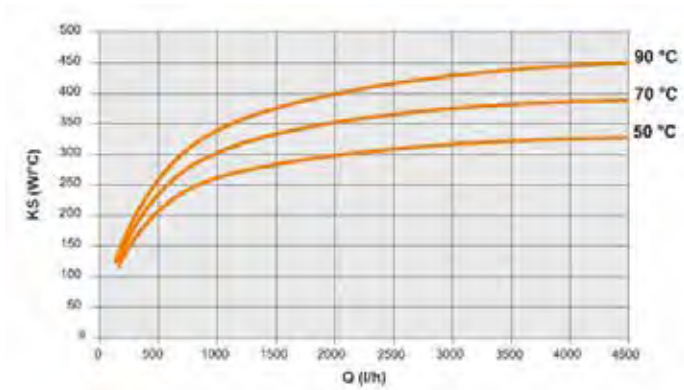

ACS300X

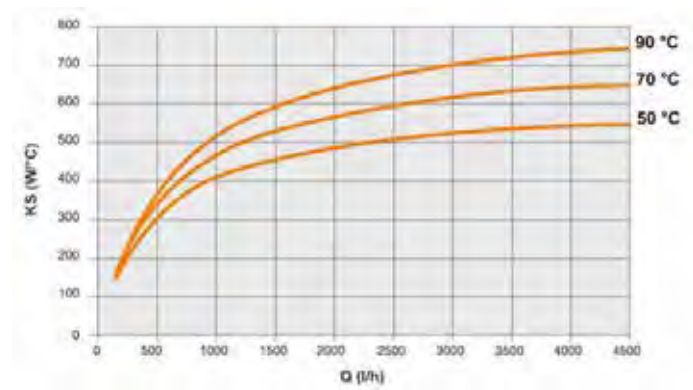

ACS500X

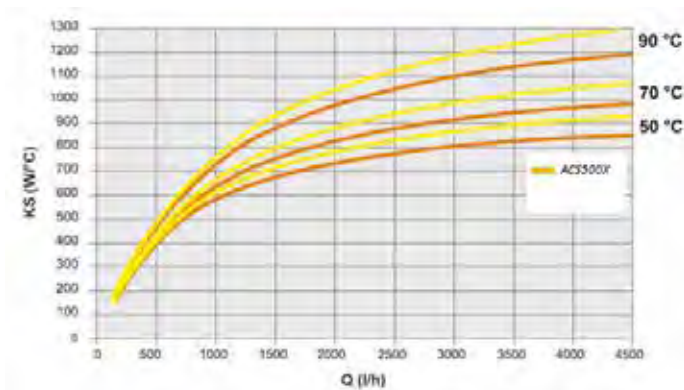

ACS1000X

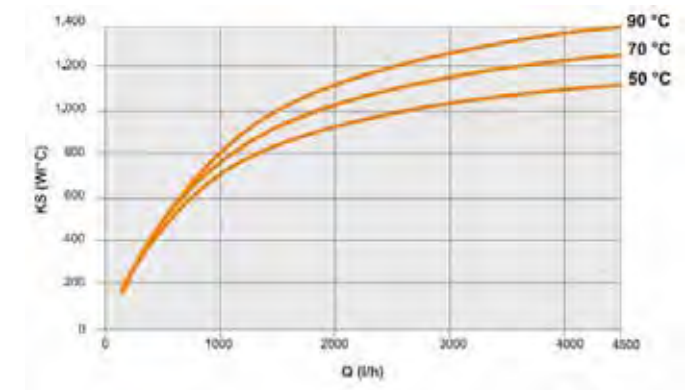

Note: Q = water flow-rate in the coil

Accessories and configurations: technical details

The boilers can be combined with solar thermal panels via an additional heat exchanger:

An additional exchanger is provided for 200, 300 or 500 litre models: accessory SCS08X for the exchanger to be combined with ACS200X or ACS300X or SCS12X for the exchanger to be combined with ACS500X. The heater must be moved to the upper position and the solar exchanger must be installed in its place.



			SCS08X	SCS12X
Solar coil	Surface	m ²	0.8	1.2
	Internal volume	l	0.65	0.95

For the 1,000 litre model, the ACS10SX boiler with integrated additional heat exchanger is available:

				ACS10SX
Performance	Net water volume	l	900	
	Energy efficiency class	-	C	
	Maximum water temperature	°C	95	
	Insulation: material / average thickness	-/mm	PE / 100	
	Heat loss	W/K	3.16	
	Electric heater	kW	4.5 / 3-phase	
Lower coil	Surface	m ²	3.7	
	Internal volume	l	23	
Upper coil	Surface	m ²	6	
	Internal volume	l	35	
Maximum operating pressure		bar	10	

Data according to DIN 4708 / EN 12897 / EN 15332
 PU = polyurethane / PE = polyester fibre

Accessories and configurations: technical details

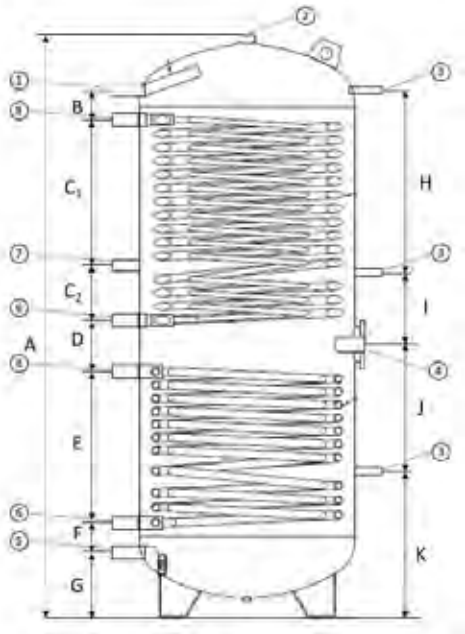

[mm]	ACS10SX		
A	2,140	G	240
B	110	H1	670
C1	535	H2	265
C2	200	I1	540
D	190	I2	465
E	555	-	-
Weight	294kg		

ACS10SX		
1	DHW supply	1"1/4
2	Anode	1"1/2
3	Temperature probe	1/2"
4	Electric heater	1"1/2
5	Cold water inlet	1"1/4
6	Exchanger return	1"1/4
7	Recirculation	1"
8	Exchanger supply	1"1/4

The power transmitted from the coils to the boiler is:

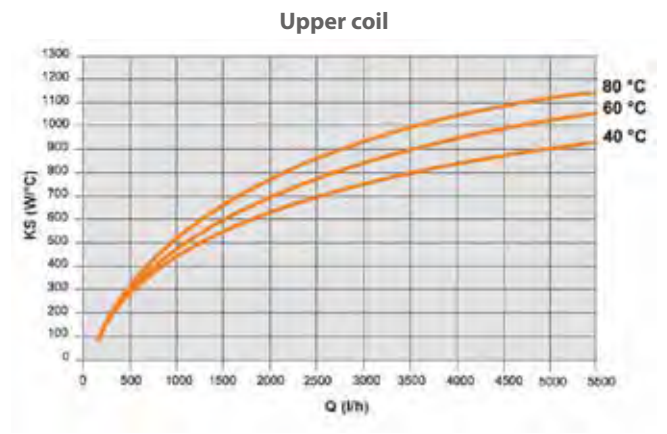
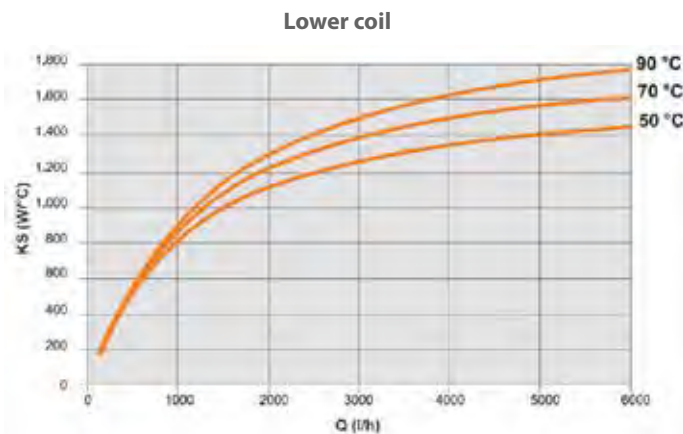

Note: Q = water flow-rate in the coil

3-way switching valve (SV1)

To connect a DHW boiler, a 3-way system/DHW switching valve, accessory 3DHWX, must be installed:

Model		2.1 TO 3.1	4.1 TO 8.1	9.1 TO 14.1
Power supply	V/Hz/p	230 / 50 / 1	230 / 50 / 1	230 / 50 / 1
Absorption	W	5	5	7
Control	-	SPST - 2-point direct system	SPST - 2-point direct system	3-wire SPST
ΔP max	bar	2	2	6
Ps	bar	10	10	16
Temperature limits - water	°C	-10 to 110	-10 to 110	-5 to 110
Temperature limits - air	°C	-5 to 55	-5 to 55	-10 to 60
Hydraulic connection	-	1" 1/4 M*	1" 1/4 M	1" 1/4 M
Cable length	mm	1,500	1,500	n.s.
Switching time	s	30	30	25

* with reductions
n.s.: not provided

Systems with primary circuit and secondary circuit

In order to optimise operation and avoid continuous on/off cycles of the unit, it is advisable to create a primary circuit and a secondary circuit by installing an inertial storage tank and/or a hydraulic separator.

Inertial storage tank

TANKX is designed to be installed under the base of the unit, so as to occupy minimum space.

The tank is 30 litres (for sizes 2.1 to 3.1), 70 litres (for sizes 4.1 to 8.1) or 100 litres (for sizes 9.1 to 14.1) and is made of RAL 9001 veined sheet metal, thermally insulated with internal foam and placed inside a painted sheet metal enclosure. It can be typically connected on the intake with the dedicated KTCAX hose kit.

Model		2.1÷3.1	4.1÷8.1	9.1÷14.1
Efficiency class	-	A	A	A
Thermal dispersion	W/K	0,38	0,48	0,60
Available volume	l	44,8	79	114
Temperature limit	°C	80	80	80
Maximum pressure	bar	6	6	6
Material	-	Acciaio DD11*		

30-litre tank (sizes 2.1 to 3.1)

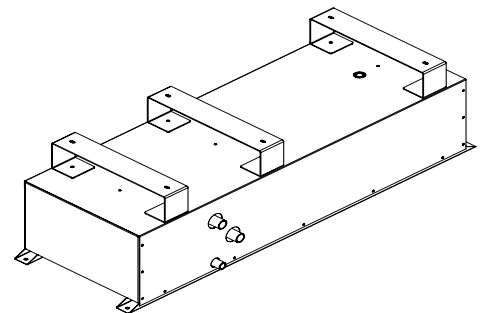
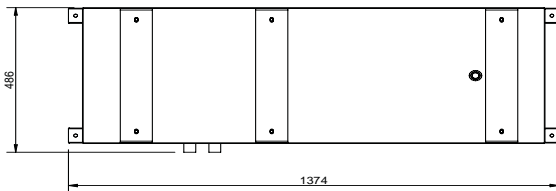
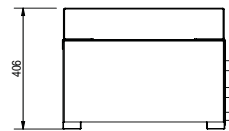
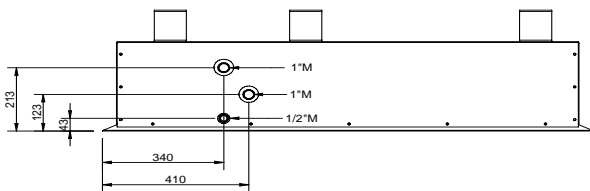

70-litre tank (sizes 4.1 to 8.1)

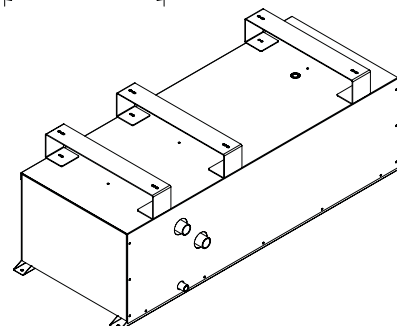
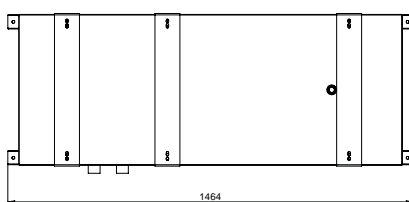
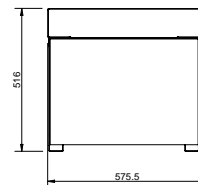
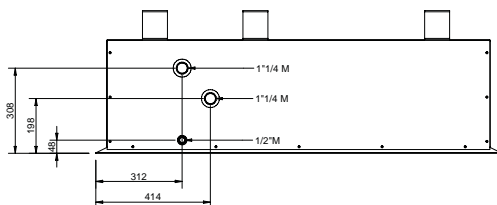

Accessories and configurations: technical details

100-litre tank (sizes 9.1 to 14.1)

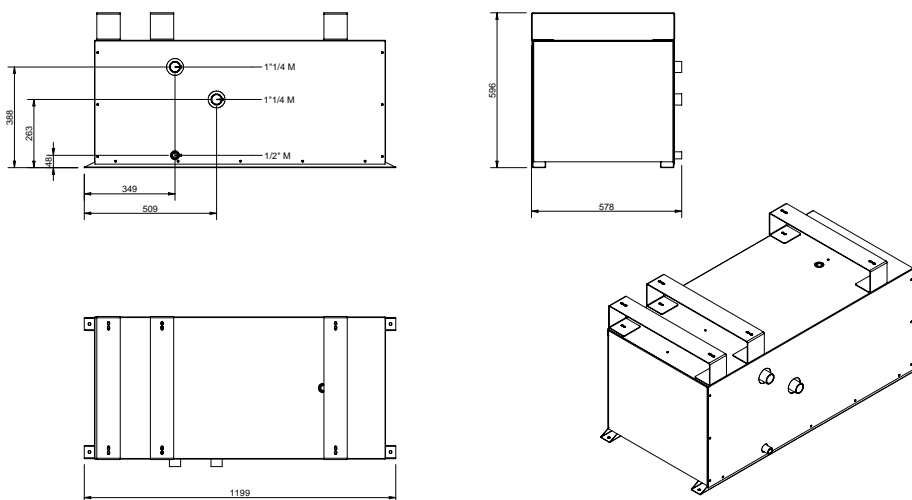

Hydraulic connections:

- Heating / cooling system

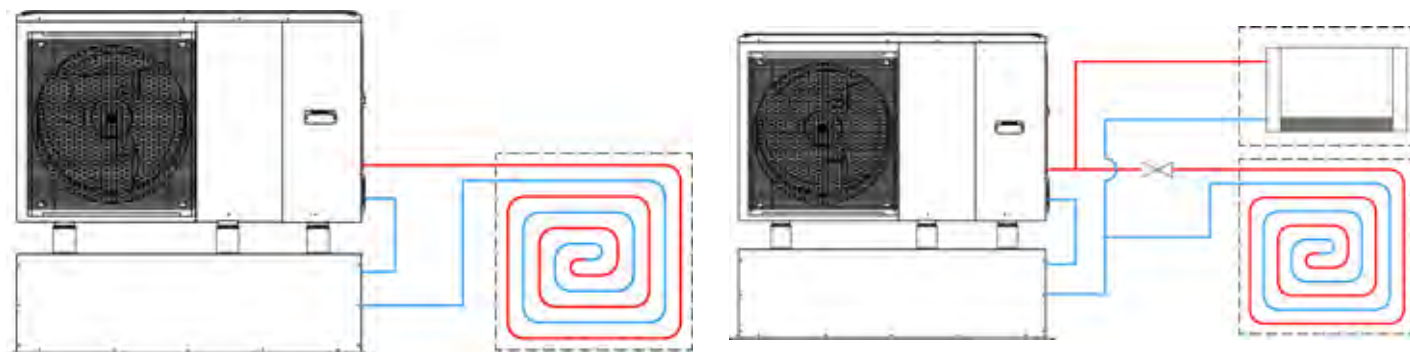

- Heating / cooling / DHW system

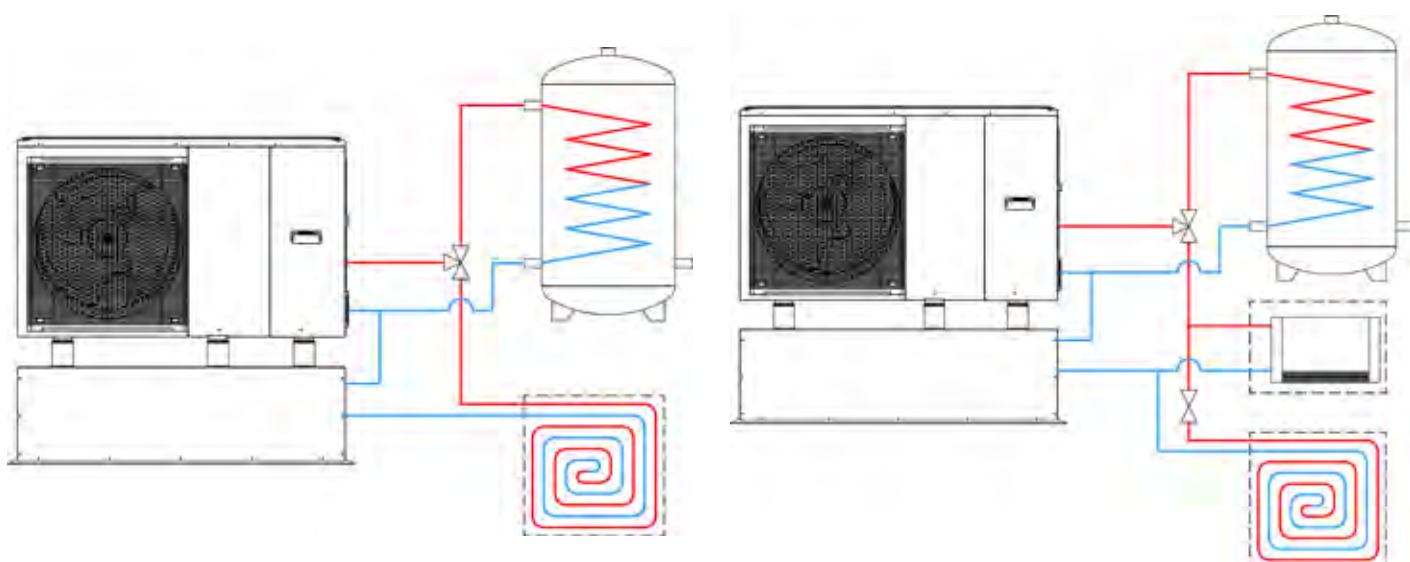

Hydraulic separator

Depending on the type of system, the water content of the system and the power of the unit, it is possible to choose a hydraulic separator with one or two pairs of inlet or outlet connections.

- separators with one pair of connections, designed for simple systems with one generator and one zone of use: DIX of 1 litre or KCSX of 1 litre and already equipped with secondary circulation pump
- separators with two pairs of connections, ideal where there are two generators or several distribution zones: DI50-2X of 50 litres or DI100X of 100 litres

Model		DIX / KCSX	DI50-2X	DI100X
Efficiency class	-	B	B	B
Maximum flow rate	l/s	0.47	-	-
Thermal dispersion	W/K	0.3	0.75	1.07
Available volume	l	0.7	45.3	45.3
Temperature limit	°C	120	80	80
Maximum pressure	bar	6	6	6
Material	-	Carbon steel	Carbon steel	Carbon steel
Unladen weight	kg	3	20	24.5

Note: all versions can be wall mounted and DI100X can also be floor-standing with special feet

DIX

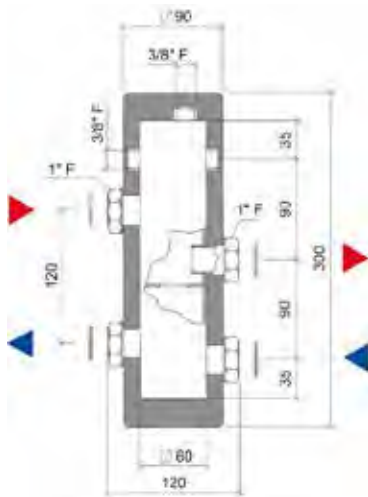

KCSX

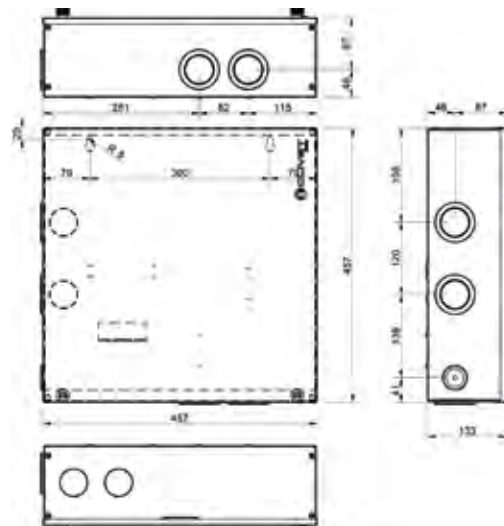
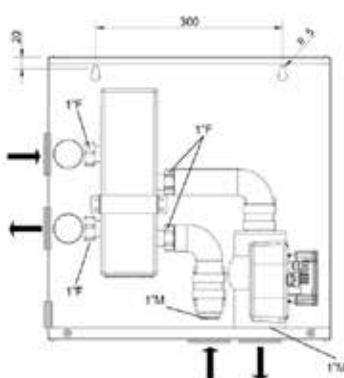

Accessories and configurations: technical details

DI50-2X

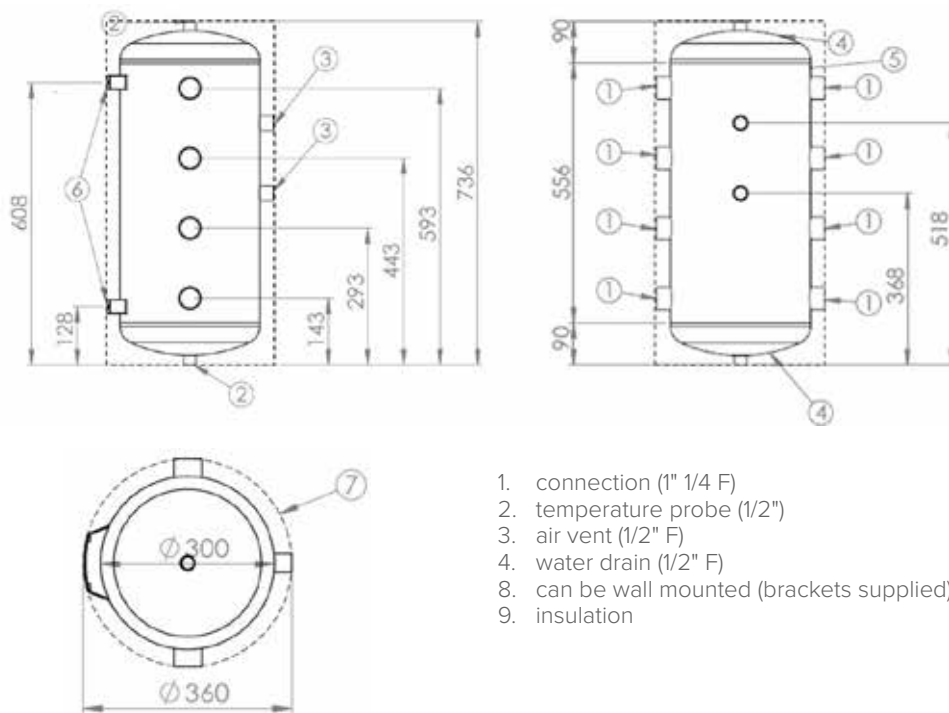

1. connection (1" 1/4 F)
2. temperature probe (1/2")
3. air vent (1/2" F)
4. water drain (1/2" F)
8. can be wall mounted (brackets supplied)
9. insulation

Note: 4 plugs and 4 gaskets are included for insertion on any unused connections

DI100X

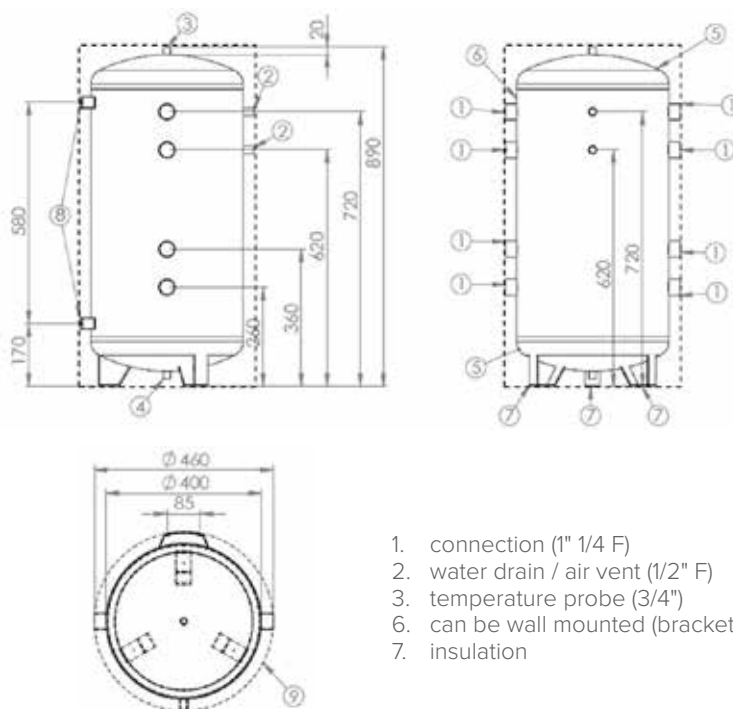

1. connection (1" 1/4 F)
2. water drain / air vent (1/2" F)
3. temperature probe (3/4")
6. can be wall mounted (brackets supplied)
7. insulation

Note: 4 plugs and 4 gaskets are included for insertion on any unused connections

Accessories and configurations: technical details

Hydraulic and electrical connections: the hydraulic separator requires the installation of a circulator for the secondary circuit P_o, managed by the unit. The Tbt1 probe can optionally be installed for controlling the unit according to the temperature of the separator.

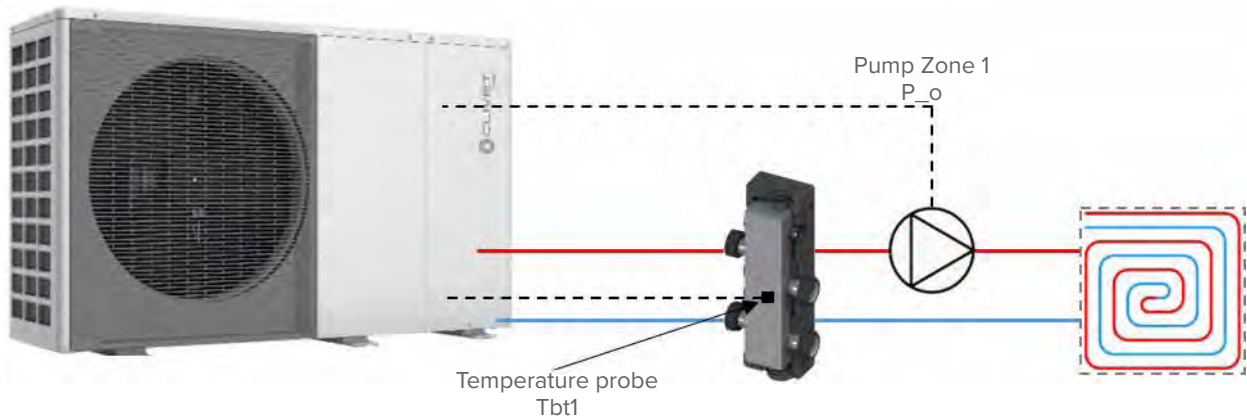

Kit for 2-zone systems

2-temperature zone systems can have two types of circulation: direct (high-temperature zone) or mixed temperature circulation (low-temperature zone). The KIRE2HX kit is designed for systems with two direct zones, while the KIRE2HLX kit is designed for systems with one direct and one mixed zone.

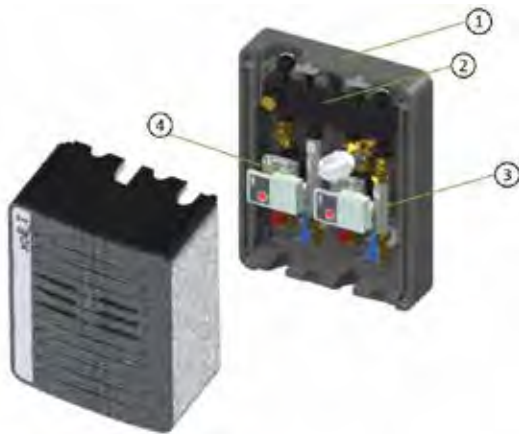

1. EPP insulation
2. Separator with 2 connections on the user side
3. Distribution unit - Zone 2 (direct or mixed)
4. Distribution unit - Zone 1 (direct)

Hydraulic connections

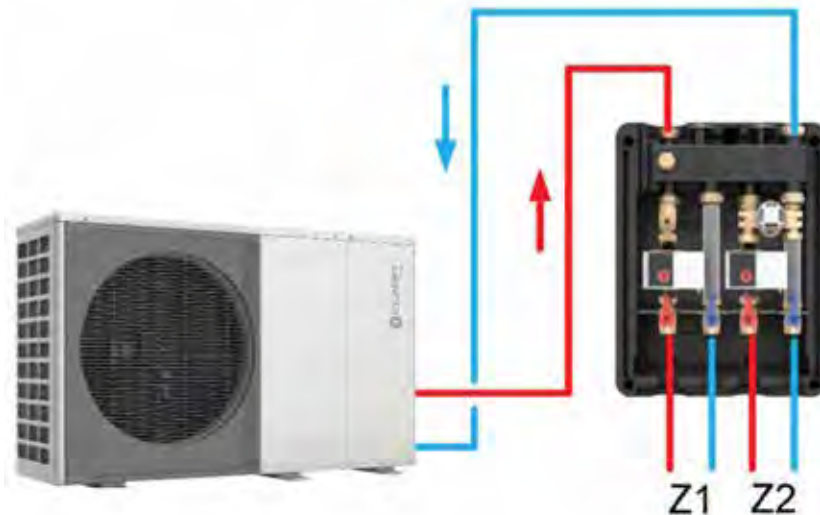

Note: for mixed Zone 2 systems, install the supplied temperature probe on the Zone 2 supply pipe of the KIRE2HLX

Accessories and configurations: technical details

Distribution units:

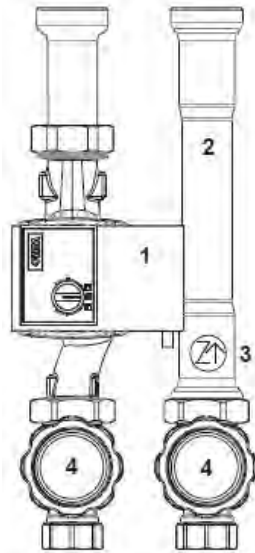

Direct

1. Wilo YONOS PARA RS 25/1-6 180 circulator
2. Pipes kit
3. Check valve
4. Ball valves with handle and thermometer

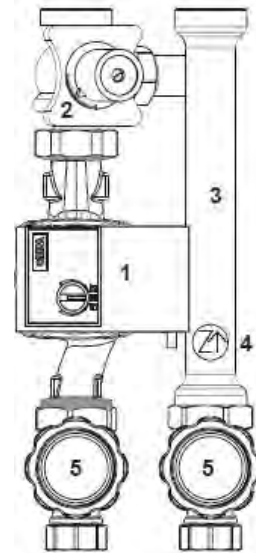

Mixed

1. Wilo YONOS PARA RS 25/1-6 180 circulator
2. DN25 TV3 sliding temperature mixing valve*
3. Pipes kit
4. Check valve
5. Ball valves with handle and thermometer

* opening/closing time: 120s

Dimensions and connections:

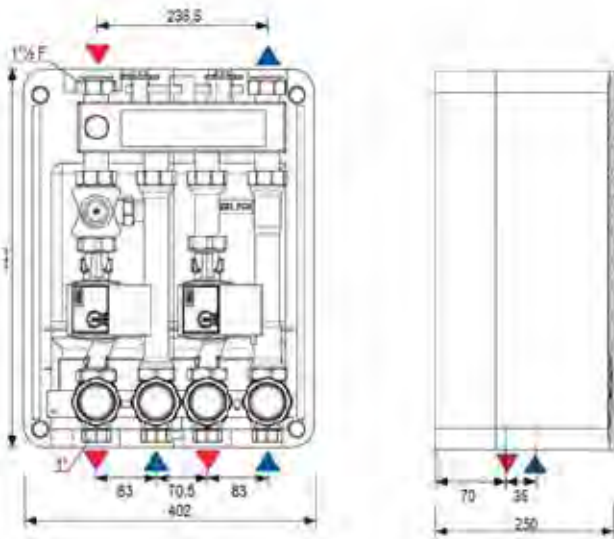

Back-up electric heater

For systems requiring a back-up heater, select one of the available accessories with field-adjustable power:

- IBHX (single-phase power supply), with deliverable power of 2/4/6 kW
- IBHTX (three-phase + N power supply), with deliverable power of 3/6/9 kW

During installation, it is possible to select a power by appropriately modifying the internal wiring and correctly selecting the protection fuses to be applied.

Note: the kit requires field connection of the T1 control probe supplied as standard with the accessory



The kit includes:

- Electric heater
- 1" 1/4 connections
- 85° C automatic reset safety thermostat
- 95° C non-automatic reset safety thermostat
- Safety contactor
- Painted steel casing
- water temperature NTC probe with 10 m cable, to be connected to the board of the unit in the field
- fuses (various power ratings to protect all available configurations)
- control contactor

Accessories and configurations: technical details

Antifreeze protection kit

The antifreeze protection kit (VAGX accessory) consists of antifreeze valves that allow the fluid to be drained out of the circuit when its temperature reaches a limit value, preventing the formation of ice in the system and consequent damage to the unit and pipes. When the water temperature falls below 3 °C (±1 °C) the valve shutter opens and drains, when the water temperature returns to 4 °C (±1 °C) the valve shutter closes.

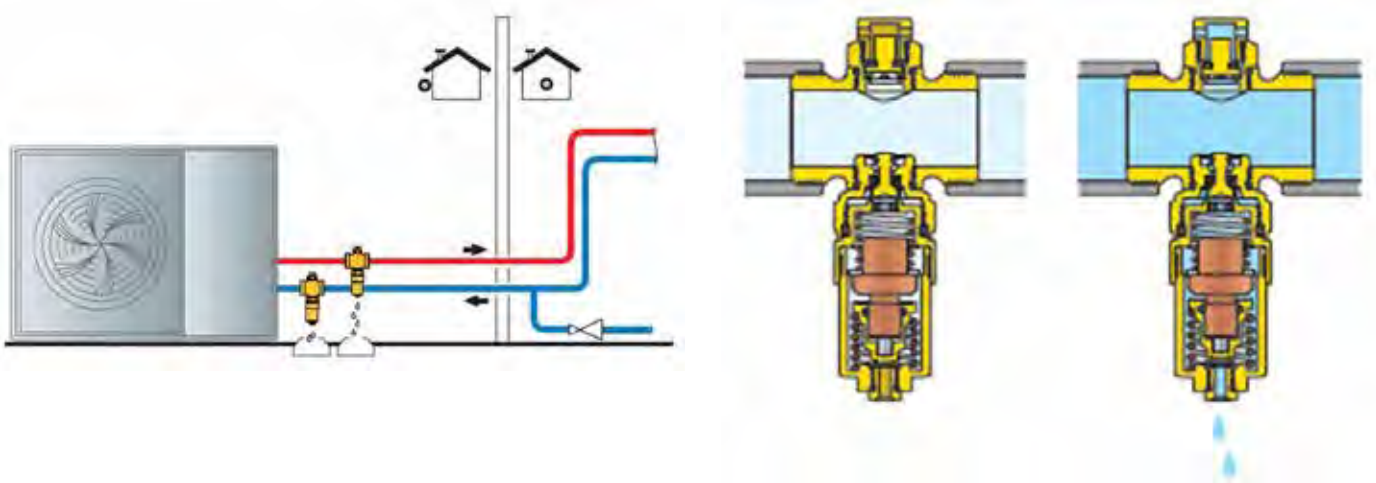

The valves must be installed outdoors, in a vertical position and on both the supply and return branches of the system

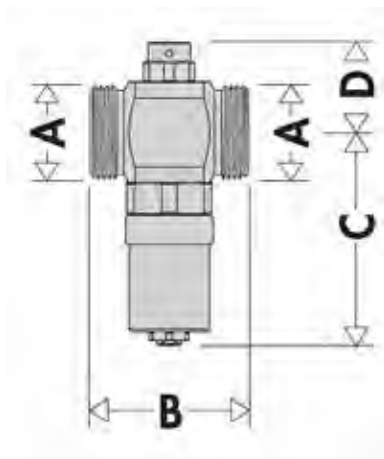

[mm]	2.1 TO 3.1	4.1 TO 8.1	9.1 TO 14.1
A	1"	1" 1/4	1" (3/4"*)
B	52	59	52
C	78.6	83	78.6
D	32	36	32

Note: the kit is already equipped with fittings for connection to the unit when required
* for connection to the plate heat exchanger

TECHNICAL DATA

Fluid of use	Water (no glycol)
Maximum operating pressure	10 bar
Operating range with water	0 to 65 °C
Operating range with air	-30 to 60
Kv	55m ³ /h (2.1 to 3.1)
	70m ³ /h (4.1 to 14.1)

Discharge conditions

outdoor T	-5 °C	-20 °C
Flow rate	0.5 l/h	1 l/h

Conditions:
- straight pipe (Ø12 mm, length 1 m) exposed to the outside
- water temperature in the building 18°C
- operating pressure 3 bar

Water temperature probe

		T1BX	T1B30X
Length	m	10	30
Bulb dimensions (φxL)	mm	6x24	6x24
NTC sensor (5 °C)	kΩ	17.6	17.6
Field of operation	°C	-3 to 105	-3 to 105
Insulation to resistance	MΩ	100	100
Voltage isolation	V	1,800	1,800
Protection rating	IP	67	67

Accessories and configurations: technical details

Auxiliary drain pan with integrated heater

The DTX accessory collects the condensate generated during unit operation and channels it to a single drainage point, so that it can be disposed of more easily. The drain pan is made of two-layer plastic material painted RAL 9001 and is equipped with a 100W 230V electric heater that automatically prevents the formation of ice with temperature set by its thermostat.

The kit includes support brackets painted RAL 9001 (with holes for installation of antivibration mounts and for fixing to base, inertial storage tank or wall brackets), screws and washers.

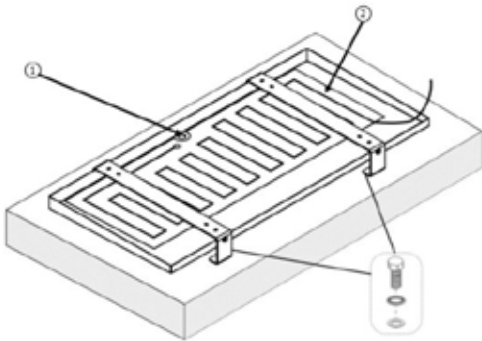

1. 1" drain hole
2. Heater

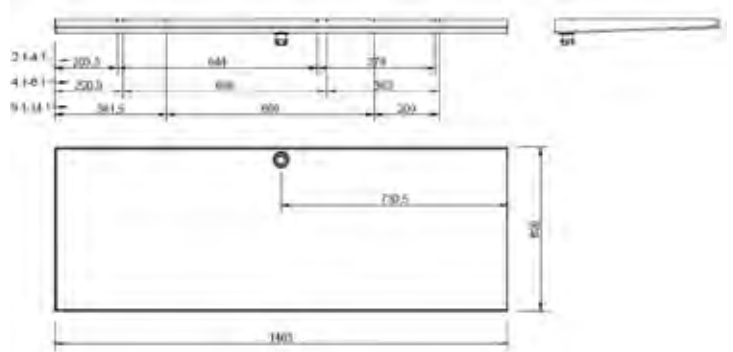

Note: the installation of vibration dampers is also mandatory with this accessory, to be applied between the unit and drain pan.

Floor-standing installation (standard)

Installation on inertial storage tank

Wall installation (with KSPIX accessory brackets)

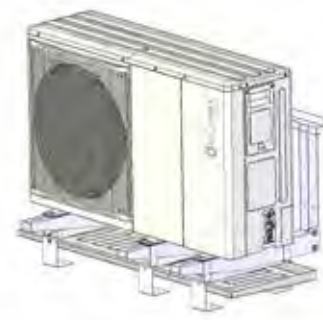
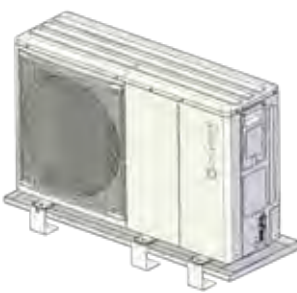

Circulators

If the system is divided into primary and secondary, the unit can manage a circulator at the secondary. PCSX is the circulator for optimal operation with sizes 2.1 to 8.1, and PCS2X for sizes 9.1 to 14.1.

The pumps are equipped with different types of control, which can be set in the field and used in different types of systems:

1) at constant speed

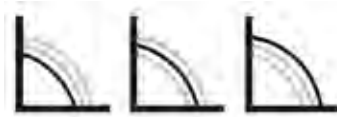

The pump works according to one of three classic preset operating curves at constant speed

2) proportional head

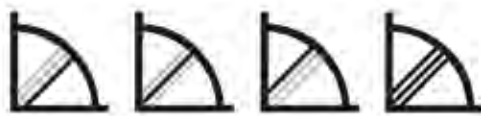

An operating curve is set in which the pump reduces the head as the heating load in the system decreases, or the pump increases the head as the load increases, in order to save energy and ensure quieter operation. It is possible to choose between three preset curves and it is advisable to use this mode in the case of distribution to terminal units or radiators.

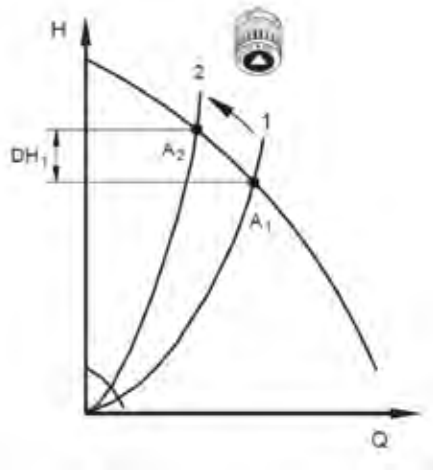

Control with standard pump
Head increases by DH_1

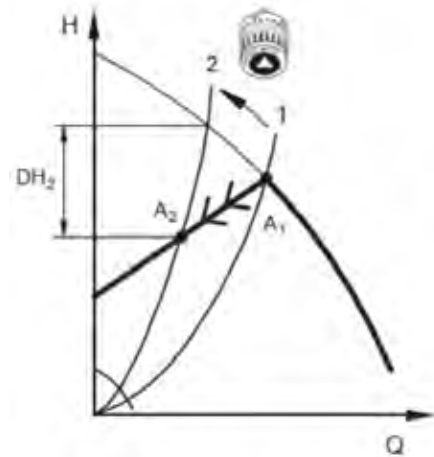

Control with proportional head pump
The head is reduced by DH_2

e.g. the heat load may be reduced, e.g. by the presence of solar radiation, during daily operation in heating mode. The valves of the distribution system are closed and the system pressure drops from A_1 to A_2 .

3) with constant head



A constant head curve is set, which the pump will maintain regardless of heating load variations in the system. It is possible to choose between three preset curves, and it is advisable to use this mode in the case of distribution to a radiant floor.

For the PCSX accessory it is possible, instead, to use logic 2 or 3, but with the AUTOADAPT function, where the pump logic automatically switches between curves to maintain constant power or to follow the system's load demands. PCS2X does not have this function.

The PRSX circulator, on the other hand, is fixed speed with 3 selectable speeds and can be used for DHW recirculation.

Accessories and configurations: technical details

Antivibration mounts

Antivibration mounts are an essential element for the correct installation of the unit as they are used to dampen noise and vibrations produced by components such as the compressor, circulators and pipes. Their installation is compulsory and their selection depends on the characteristics of the site: in the case of the Edge EVO 2.0 - EXC units, one element is required for each supporting point, for a total of 6 vibration dampers.

- antivibration kits for installation on the floor (AMRX accessory) or on brackets, inertial storage tank or drain pan (ASTFX accessory): 6 rubber vibration dampers fitted with screws for attachment to the unit.
They consist of two plates made of galvanised steel discs, coated with recyclable thermoplastic elastomer material suitable for temperatures of -45 to 110 °C, with high resistance to ageing, pollutants, hydrocarbons, salt spray, UV radiation and detergents. AMRX is also equipped with a steel base plate with holes for anchoring to the base.

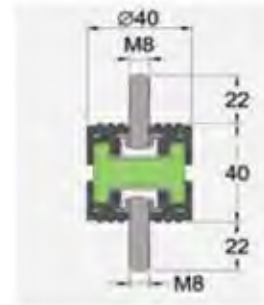
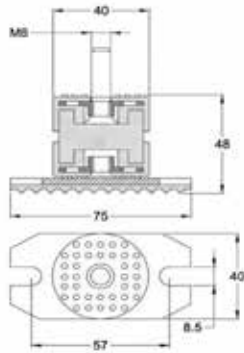

- Anti-seismic antivibration kits for floor installation (AMMSX): 6 spring-loaded vibration dampers equipped with a screw for fixing to the unit and a base plate with holes for anchoring to the base.
They consist of a sandblasted, painted steel frame and a painted steel spring and are designed to act both as vibration isolators and as seismic restraints to prevent the unit from tipping over in the event of an earthquake or wind.

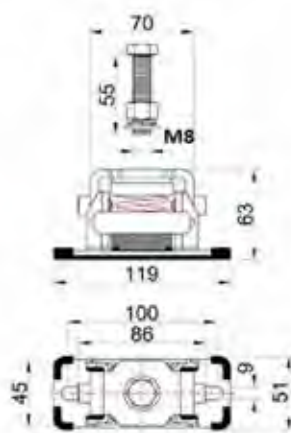

Wall-mounted installation with brackets

Adjustable wall mounting brackets (KSIPX accessory) for wall-mounted installation of the unit. They are made of galvanised steel painted with polyester powder, suitable for outdoor installation exposed to the elements.

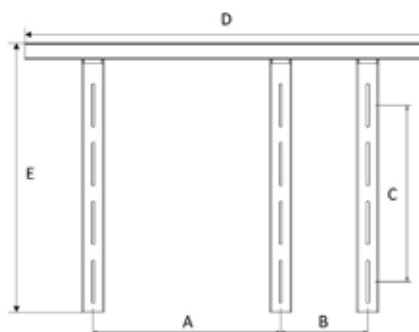
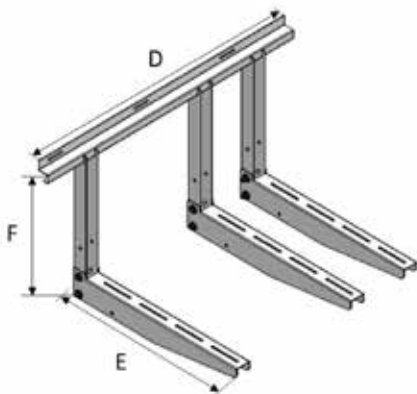

[mm]	2.1 TO 3.1	4.1 TO 8.1	9.1 TO 14.1
A	644	656	668
B	379	363	206
C	375	469	494
D	1,200		
E	860		
F	600		

Management with Wi-Fi zone thermostat

The semi-recessed chronothermostat HID-TCXBX (black version) or HID-TCXNX (white version) is designed for system management via touch interface, App or Alexa voice or Google Home assistant.

Thermostat languages: ITA / ENG / FRA / GER / SPA, App languages: ITA / ENG / FRA / GER / SPA / CRO / POL / SER / NED



- display: soft-touch colour
- SwitchConnect paired receivers: max. 2
- power supply: 100-253V / 50-60Hz
- settable temperature: 5-40 °C
- antifreeze temperature: 2-25 °C
- temperature offset: ± 5 °C (std 0 °C)
- degree of protection: IP30
- Wi-Fi: 802.11 b/g/n
- self-adjusting clock via web with back-up battery
- dimensions: 122x82x15 mm

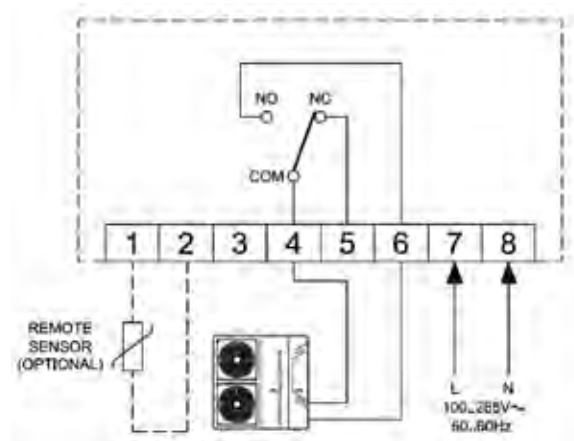

✓ Connection to a zone; the thermostat manages the request and the HMI manages the mode change



Accessories and configurations: technical details

✓ Two-zone connection: each thermostat manages the request of its own zone, the mode is changed by the HMI

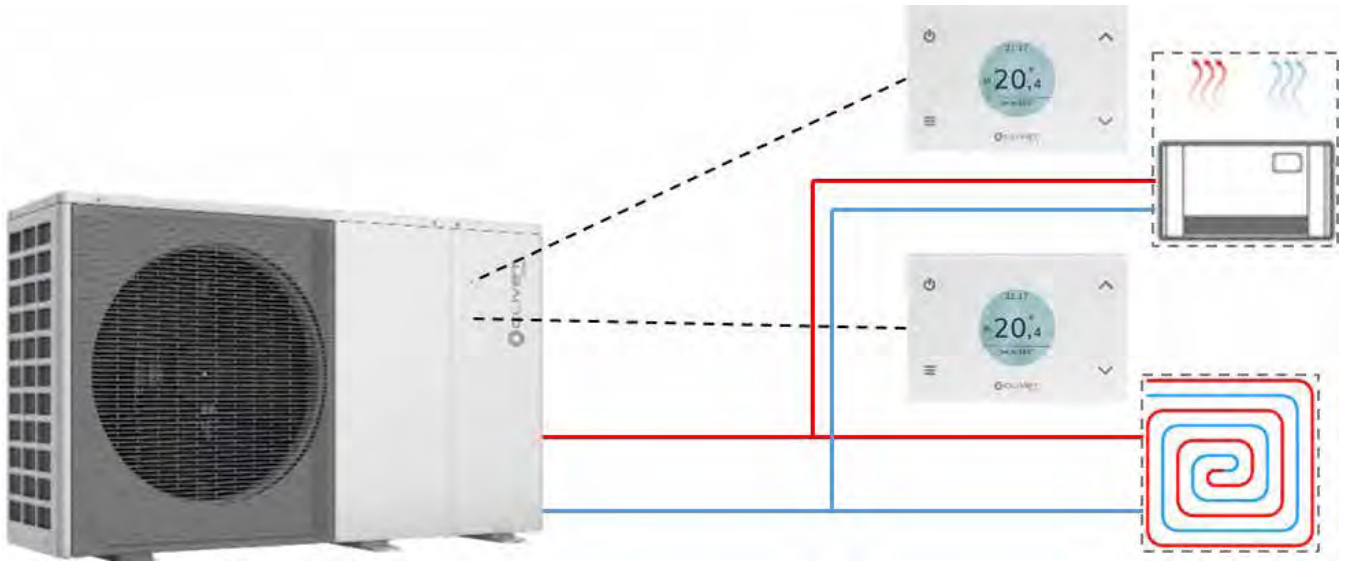

System management via Clivet Home Connect App:

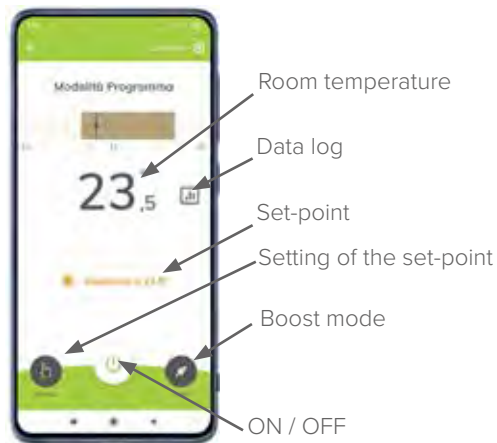

✓ automatic management with scheduler or manual setting



Manual setting

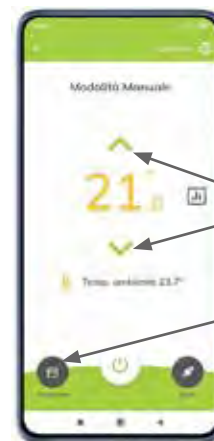

Manual setting of the set-point
Weekly scheduling

Accessories and configurations: technical details

✓ Boost mode, forced start-up of the system

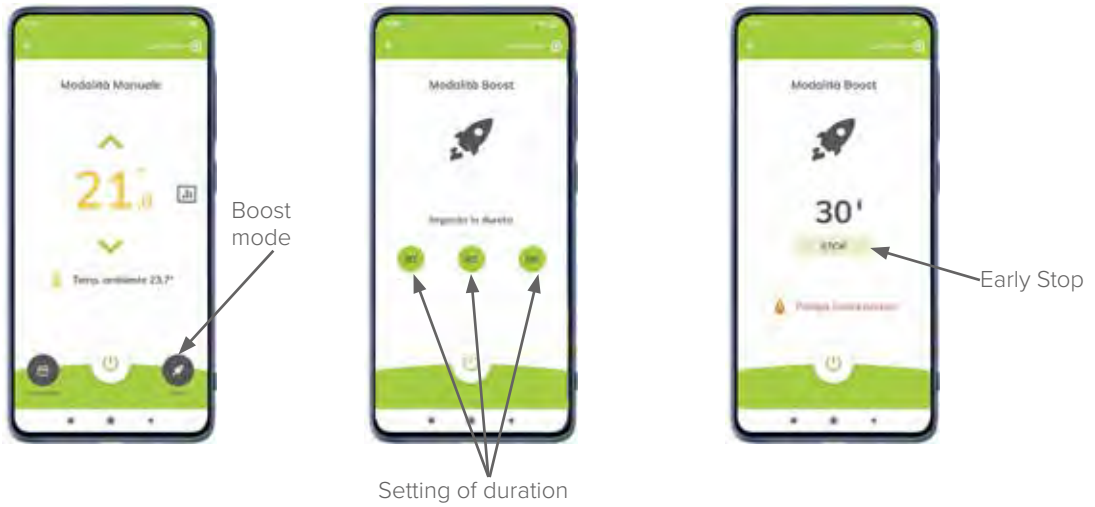

✓ System data log



✓ Weekly scheduling



Accessories and configurations: technical details

The SWCX receiver can be used to set up a wireless system:

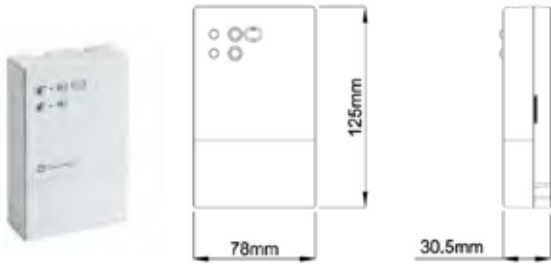

- ✓ combinable thermostats: max. 6
- ✓ frequency: 2.4GHz
- ✓ transmission distance: max 30m (in buildings) / max 100m (in open range)
- ✓ contacts: 2 relays (voltage-free)
- ✓ power supply: 95 to 290V / 47 to 440Hz
- ✓ operating temperature: 0 to 40 °C
- ✓ operating humidity: 20 to 80% RH
- ✓ dimensions: 125x78x30.5 mm

- ✓ connection to a zone: the thermostat manages the request via SWCX with Wi-Fi signal and can enable distribution, while the HMI manages the mode change



- ✓ connection to a zone with mode change: the thermostat manages the request and mode change of the unit via SWCX with Wi-Fi signal and can enable the distribution



- ✓ Two-zone connection: each thermostat manages the request of its own zone and can enable distribution, the mode is changed by the HMI



Simplified diagrams of the system

Heating/cooling

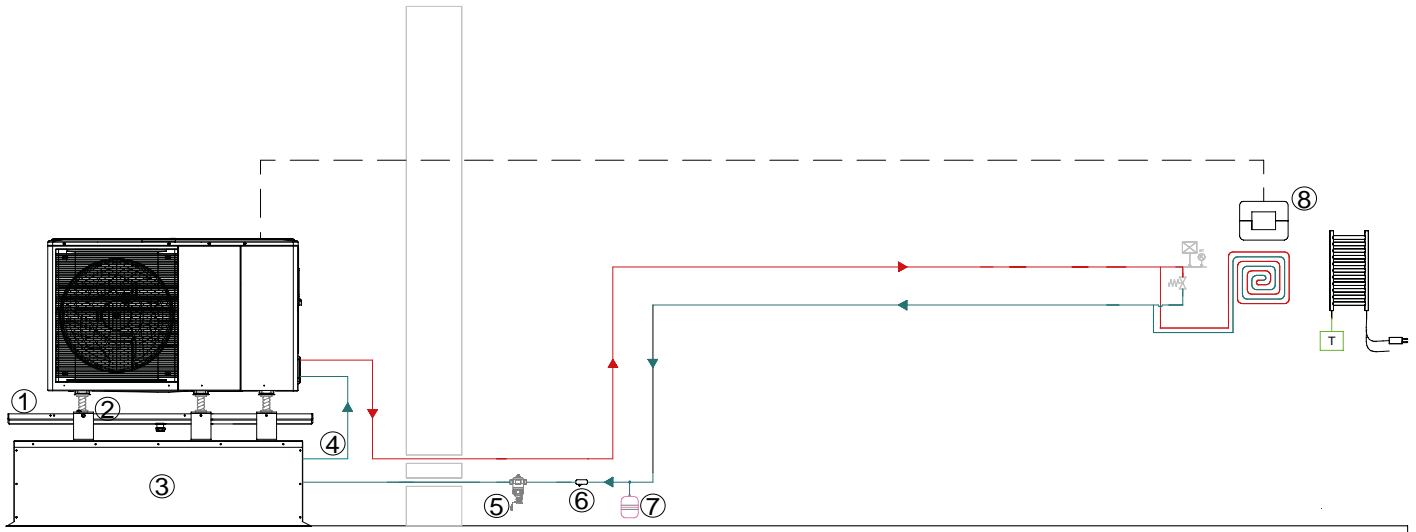

- 1 - DTX: Drain pan with electric heater
- 2 - ASTFX: Kit of antivibration mounts for installation on wall brackets, inertial storage tank or tray
- 3 - TANKX: system's inertial storage tank
- 4 - KTCAX: Hose kit for connecting the unit to the inertial storage tank
- 5 - FDMX: Magnetic dirt separator filter for water distribution systems
- 6 - mesh filter (supplied as standard with the unit)
- 7 - additional expansion tank (externally supplied)
- 8 - HID-TCXNX: white HID-TConnect chronothermostat

Heating/cooling with primary and secondary

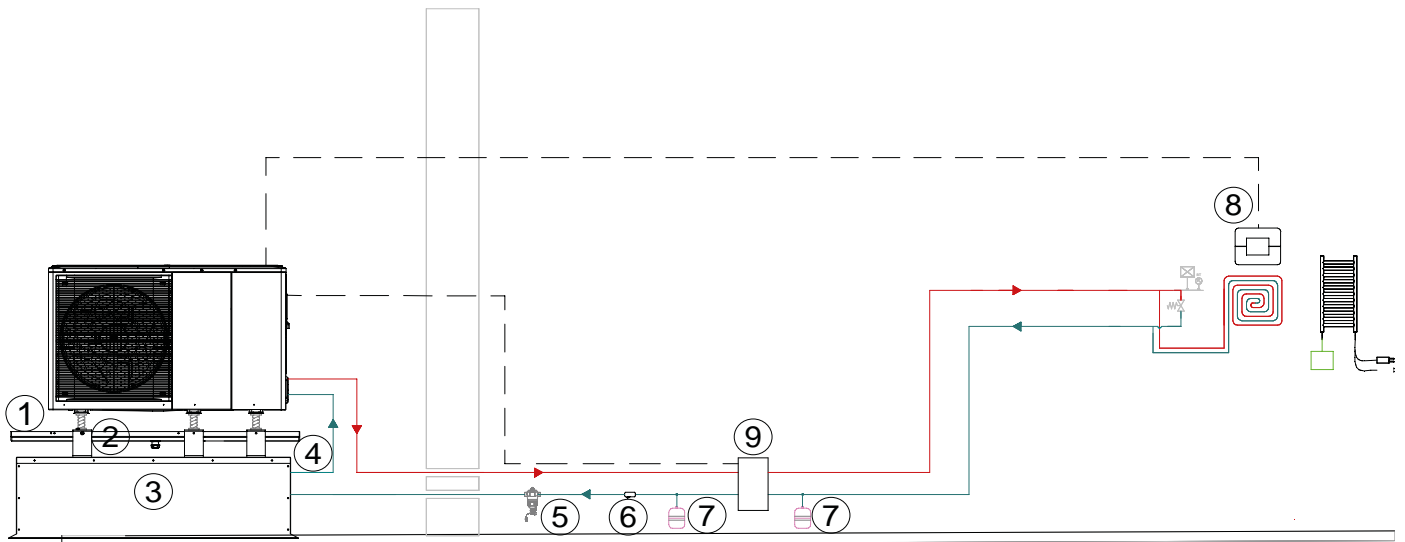

- 1 - DTX: Drain pan with electric heater
- 2 - ASTFX: Kit of antivibration mounts for installation on wall brackets, inertial storage tank or tray
- 3 - TANKX: inertial storage tank
- 4 - KTCAX: Hose kit for connecting the unit to the inertial storage tank
- 5 - FDMX: Magnetic dirt separator filter for water distribution systems
- 6 - mesh filter (supplied as standard with the unit)
- 7 - additional expansion tank (externally supplied)
- 8 - HID-TCXNX: white HID-TConnect chronothermostat
- 9 - Secondary circuit kit (1-litre hydraulic circuit breaker + pump)

Simplified diagrams of the system

Heating/cooling/DHW

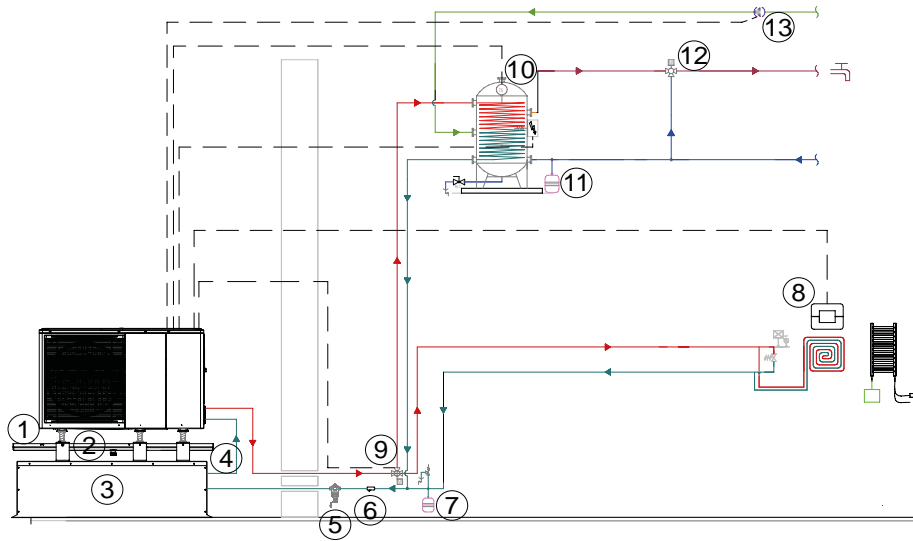

- 1 - DTX: Drain pan with electric heater
- 2 - ASTFX: Kit of antivibration mounts for installation on wall brackets, inertial storage tank or tray
- 3 - TANKX: system's inertial storage tank
- 4 - KTCAX: Hose kit for connecting the unit to the inertial storage tank
- 5 - FDMX: Magnetic dirt separator filter for water distribution systems
- 6 - mesh filter (supplied as standard with the unit)
- 7 - additional expansion tank (externally supplied)
- 8 - HID-TCXNX: white HID-TConnect chronothermostat
- 9 - 3DHWX: 3-way system/DHW switching valve
- 10 - ACS300X: DHW boiler / T1BX: DHW temperature probe / QERAX: Connection kit for heater on DHW storage tank
- 11 - DHW expansion tank (externally supplied)
- 12 - anti-scalding valve
- 13 - PRSX: DHW recirculation pump

Heating/cooling with 2-zone system (dual emitter)

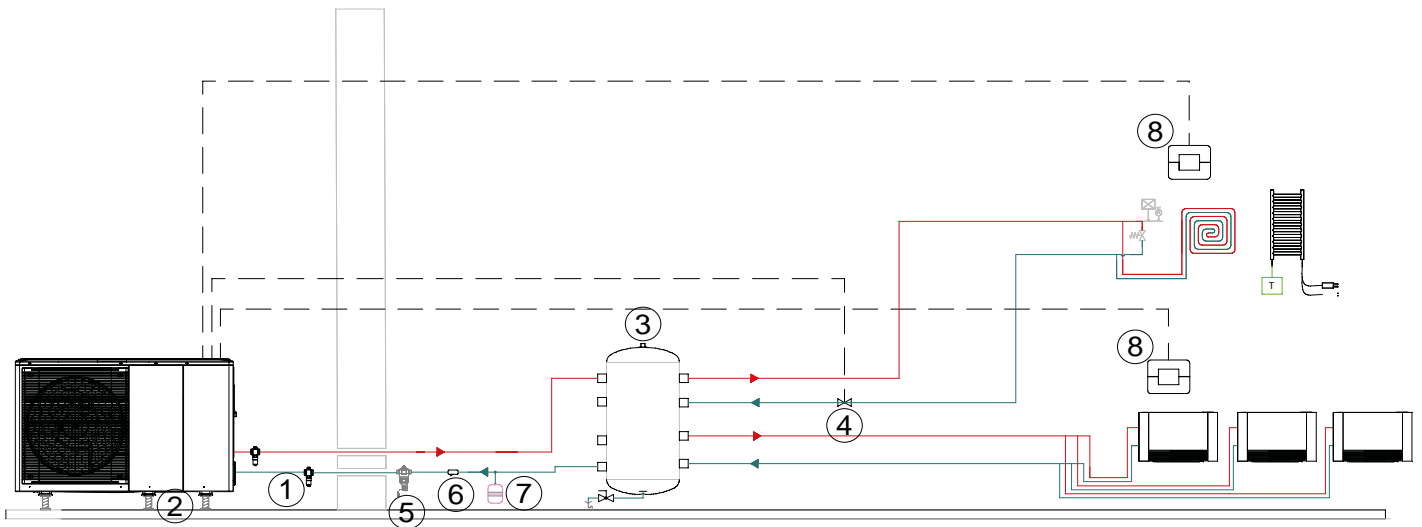

- 1 - VAGX: Safety antifreeze valve for system
- 2 - AMRX: Kit of antivibration mounts for floor installation
- 3 - DI50-2X: 50-litre hydraulic circuit breaker
- 4 - 2-way valve (externally supplied)
- 5 - FDMX: Magnetic dirt separator filter for water distribution systems
- 6 - mesh filter (supplied as standard with the unit)
- 7 - additional expansion tank (externally supplied)
- 8 - HID-TCXNX: white HID-TConnect chronothermostat

Heating/cooling with 2-zone system (mixed zone 2)

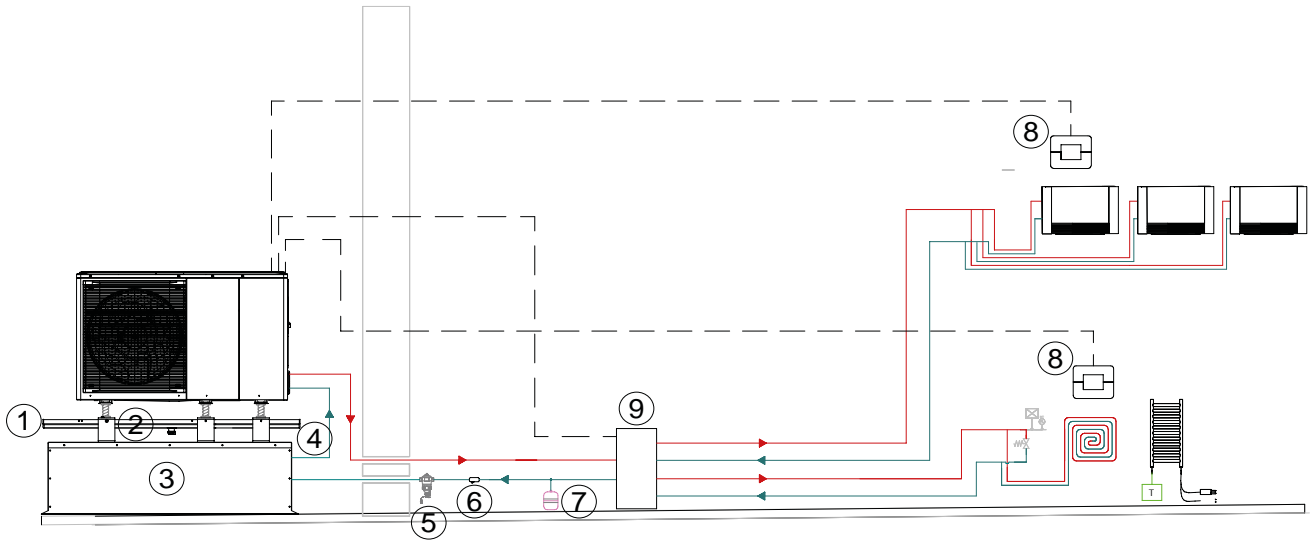

- 1 - DTX: Drain pan with electric heater
- 2 - ASTFX: Kit of antivibration mounts for installation on wall brackets, inertial storage tank or tray
- 3 - TANKX: inertial storage tank
- 4 - KTCAX: Hose kit for connecting the unit to the inertial storage tank
- 5 - FDMX: Magnetic dirt separator filter for water distribution systems
- 6 - mesh filter (supplied as standard with the unit)
- 7 - additional expansion tank (externally supplied)
- 8 - HID-TCXNX: white HID-TConnect chronothermostat
- 9 - KIRE2HLX: Double zone distribution unit: direct + mixed (with mixing valve)

Heating/cooling/DHW with 2-zone system (direct zone 2)

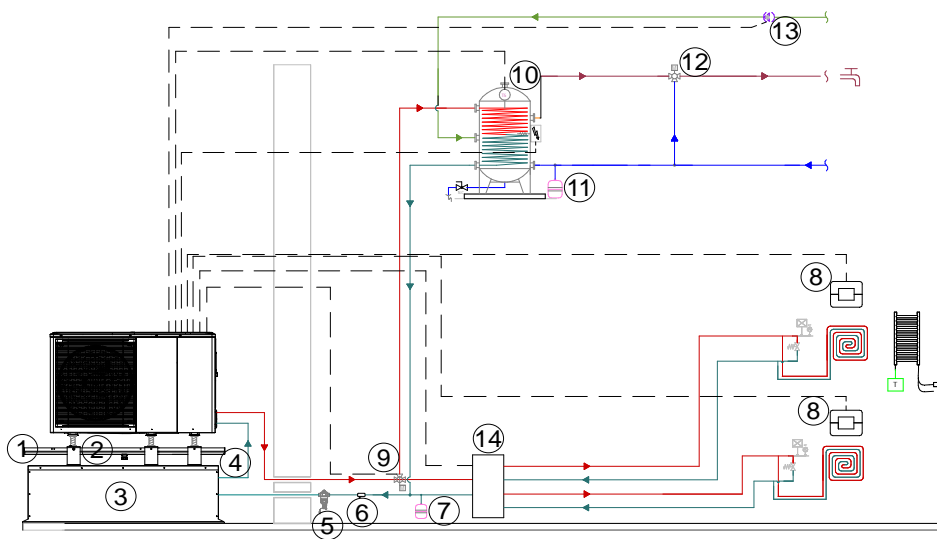

- 1 - DTX: Drain pan with electric heater
- 2 - ASTFX: Kit of antivibration mounts for installation on wall brackets, inertial storage tank or tray
- 3 - TANKX: system's inertial storage tank
- 4 - KTCAX: Hose kit for connecting the unit to the inertial storage tank
- 5 - FDMX: Magnetic dirt separator filter for water distribution systems
- 6 - mesh filter (supplied as standard with the unit)
- 7 - additional expansion tank (externally supplied)
- 8 - HID-TCXNX: white HID-TConnect chronothermostat
- 9 - 3DHWX: 3-way system/DHW switching valve
- 10 - ACS300X: DHW boiler / T1BX: DHW temperature probe / QERAX: Connection kit for heater on DHW storage tank
- 11 - DHW expansion tank (externally supplied)
- 12 - anti-scalding valve
- 13 - PRSX: DHW recirculation pump
- 14 - KIRE2HX: Double zone distribution unit: direct + direct

System diagrams

Heating/cooling/DHW with 2-zone system (mixed zone 2)

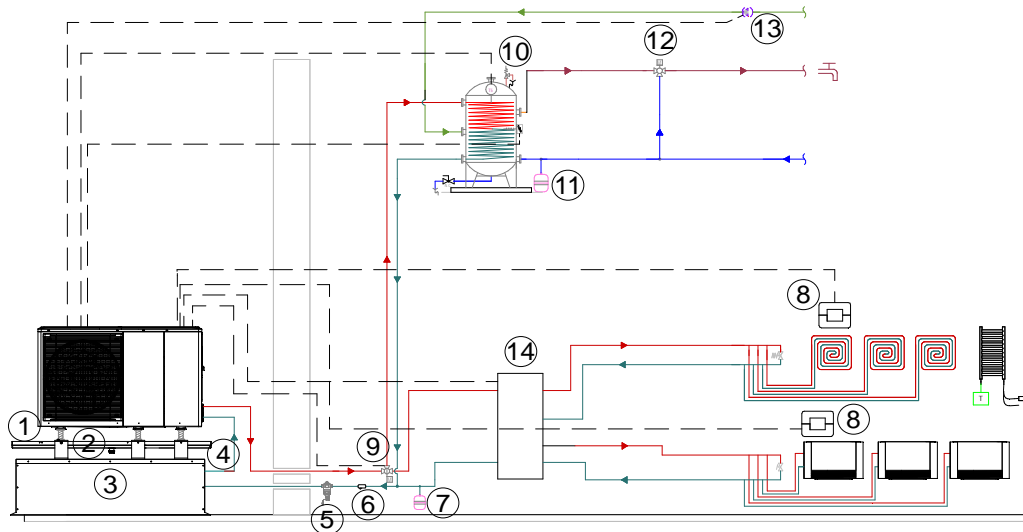

- 1 - DTX: Drain pan with electric heater
- 2 - ASTFX: Kit of antivibration mounts for installation on wall brackets, inertial storage tank or tray
- 3 - TANKX: system's inertial storage tank
- 4 - KTCAX: Hose kit for connecting the unit to the inertial storage tank
- 5 - FDMX: Magnetic dirt separator filter for water distribution systems
- 6 - mesh filter (supplied as standard with the unit)
- 7 - additional expansion tank (externally supplied)

- 8 - HID-TCXNX: white HID-TConnect chronothermostat
- 9 - 3DHWX: 3-way system/DHW switching valve
- 10 - ACS300X: DHW boiler / T1BX: DHW temperature probe / QERAX: Connection kit for heater on DHW storage tank
- 11 - DHW expansion tank (externally supplied)
- 12 - anti-scalding valve
- 13 - PRSX: DHW recirculation pump
- 14 - KIRE2HLX: Double zone distribution unit: direct + mixed (with mixing valve)

Heating/cooling with dedicated heat pump for DHW

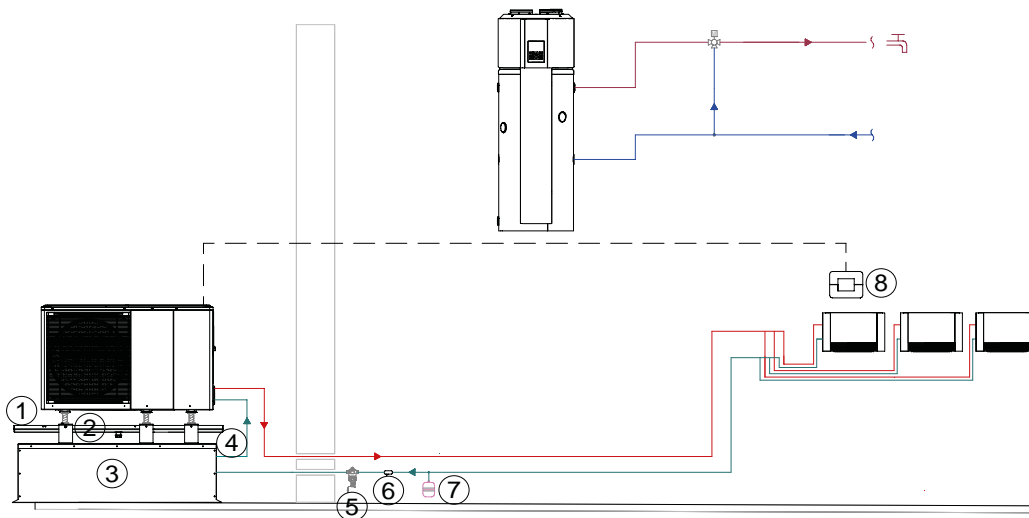

- 1 - DTX: Drain pan with electric heater
- 2 - ASTFX: Kit of antivibration mounts for installation on wall brackets, inertial storage tank or tray
- 3 - TANKX: inertial storage tank
- 4 - KTCAX: Hose kit for connecting the unit to the inertial storage tank
- 5 - FDMX: Magnetic dirt separator filter for water distribution systems
- 6 - mesh filter (supplied as standard with the unit)
- 7 - additional expansion tank (externally supplied)
- 8 - HID-TCXNX: white HID-TConnect chronothermostat

Heating / cooling / DHW with solar thermal circuit

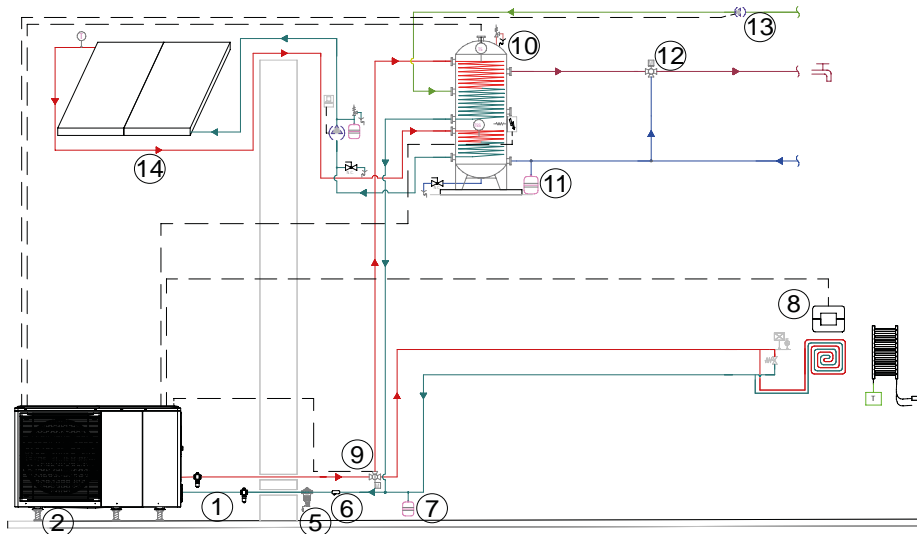

- 1 - VAGX: Safety antifreeze valve for system
- 2 - AMRX: Kit of antivibration mounts for floor installation
- 3 - DI50-2X: 50-litre hydraulic circuit breaker
- 4 - 2-way valve (externally supplied)
- 5 - FDMX: Magnetic dirt separator filter for water distribution systems
- 6 - mesh filter (supplied as standard with the unit)
- 7 - additional expansion tank (externally supplied)
- 8 - HID-TCXNX: white HID-TConnect chronothermostat

- 9 - 3DHWX: 3-way system/DHW switching valve
- 10 - ACS300X: DHW boiler / T1BX: DHW temperature probe / QERAX: Connection kit for heater on DHW storage tank
- 11 - DHW expansion tank (externally supplied)
- 12 - anti-scalding valve
- 13 - PRSX: DHW recirculation pump
- 14 - ELFOSun solar thermal circuit

Heating / cooling / DHW with electric heater

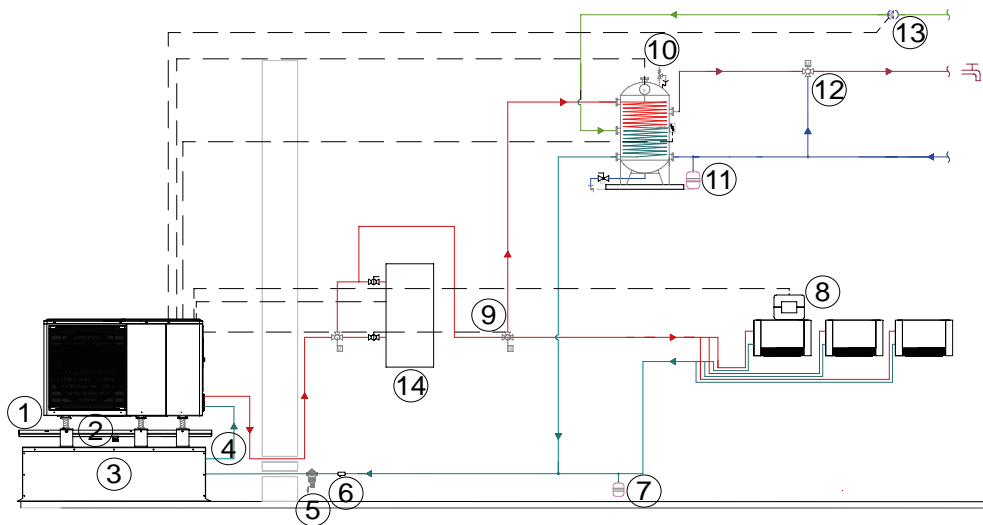

- 1 - DTX: Drain pan with electric heater
- 2 - ASTFX: Kit of antivibration mounts for installation on wall brackets, inertial storage tank or tray
- 3 - TANKX: system's inertial storage tank
- 4 - KTCAX: Hose kit for connecting the unit to the inertial storage tank
- 5 - FDMX: Magnetic dirt separator filter for water distribution systems
- 6 - mesh filter (supplied as standard with the unit)
- 7 - additional expansion tank (externally supplied)
- 8 - HID-TCXNX: white HID-TConnect chronothermostat

- 9 - 3DHWX: 3-way system/DHW switching valve
- 10 - ACS300X: DHW boiler / T1BX: DHW temperature probe / QERAX: Connection kit for heater on DHW storage tank
- 11 - DHW expansion tank (externally supplied)
- 12 - anti-scalding valve
- 13 - PRSX: DHW recirculation pump
- 14 - IBHX: electric heater

System diagrams

Heating / DHW with back-up boiler

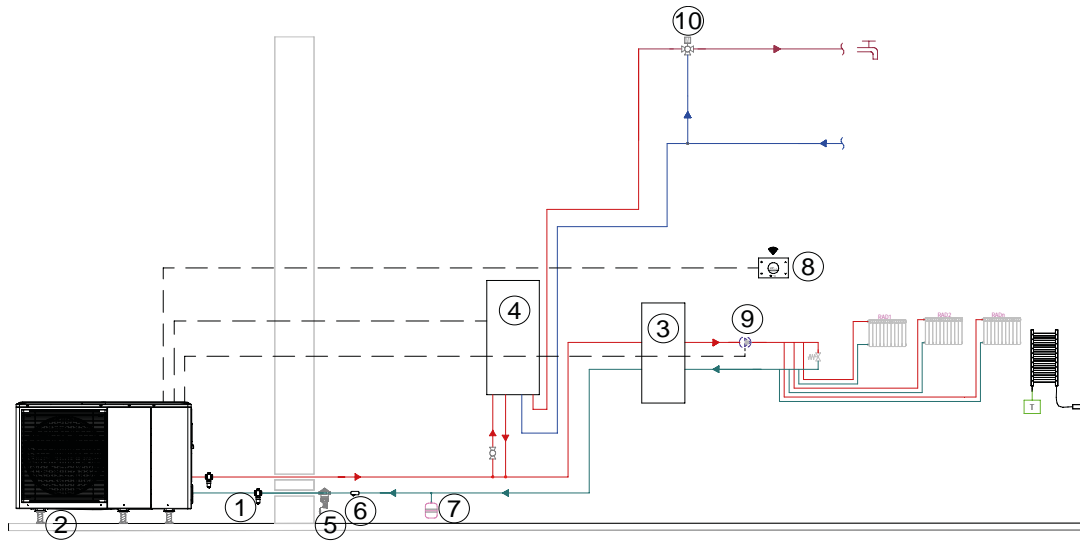

- 1 - VAGX: Safety antifreeze valve for system
- 2 - AMRX: Kit of antivibration mounts for floor installation
- 3 - DI50-2X: 50-litre hydraulic circuit breaker
- 4 - GAS BOILER: boiler for stand-alone systems
- 5 - FDMX: Magnetic dirt separator filter for water distribution systems
- 6 - mesh filter (supplied as standard with the unit)
- 7 - additional expansion tank (externally supplied)
- 8 - HID-TCXNX: white HID-TConnect chronothermostat
- 9 - PCSX: secondary circuit pump
- 10 - anti-scalding valve

Heating / cooling / DHW with back-up boiler

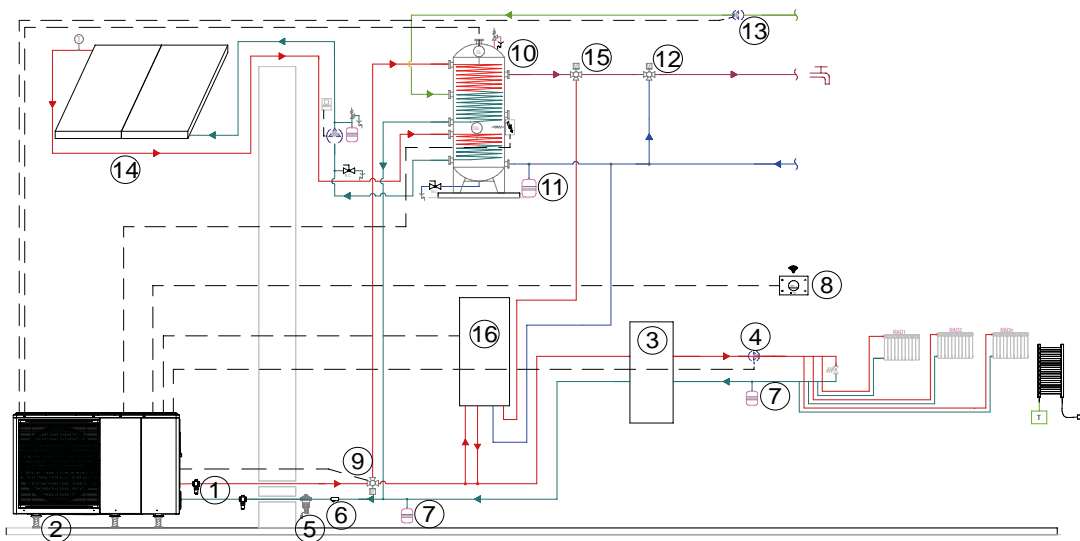

- | | |
|--|---|
| <ul style="list-style-type: none"> 1 - VAGX: Safety antifreeze valve for system 2 - AMRX: Kit of antivibration mounts for floor installation 3 - DI50-2X: 50-litre hydraulic circuit breaker 4 - PCSX: secondary circuit pump 5 - FDMX: Magnetic dirt separator filter for water distribution systems 6 - mesh filter (supplied as standard with the unit) 7 - additional expansion tank (externally supplied) 8 - HID-TCXNX: white HID-TConnect chronothermostat 9 - 3DHWX: 3-way system/DHW switching valve | <ul style="list-style-type: none"> 10 - ACS300X: DHW boiler / T1BX: DHW temperature probe / QERAX: Connection kit for heater on DHW storage tank 11 - DHW expansion tank (externally supplied) 12 - anti-scalding valve 13 - PRSX: DHW recirculation pump 14 - ELFOsun solar thermal circuit 15 - VDACSX: thermostatic switching valve for DHW 16 - GAS BOILER: boiler for stand-alone systems |
|--|---|

Cascade x 4 Heating / cooling / DHW units

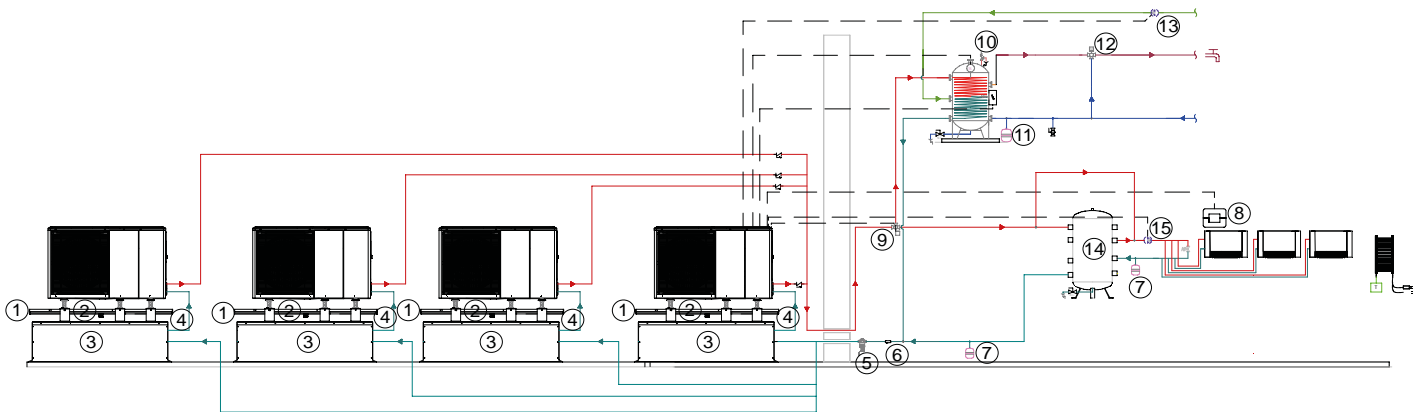

- 1 - DTX: Drain pan with electric heater
- 2 - ASTFX: Kit of antivibration mounts for installation on wall brackets, inertial storage tank or tray
- 3 - TANKX: system's inertial storage tank
- 4 - KTCAX: Hose kit for connecting the unit to the inertial storage tank
- 5 - FDMX: Magnetic dirt separator filter for water distribution systems
- 6 - mesh filter (supplied as standard with the unit)
- 7 - additional expansion tank (externally supplied)
- 8 - HID-TCXNX: white HID-TConnect chronothermostat

- 9 - 3DHWX: 3-way system / DHW switching valve
- 10 - ACS300X: DHW boiler / T1BX: DHW temperature probe / QERAX: Connection kit for heater on DHW storage tank
- 11 - DHW expansion tank (externally supplied)
- 12 - anti-scalding valve
- 13 - PRSX: DHW recirculation pump
- 14 - DH100X: 100-litre hydraulic circuit breaker
- 15 - PCS2X: oversized pump for secondary circuit

Cascade x 4 Heating / cooling / DHW units with back-up boiler

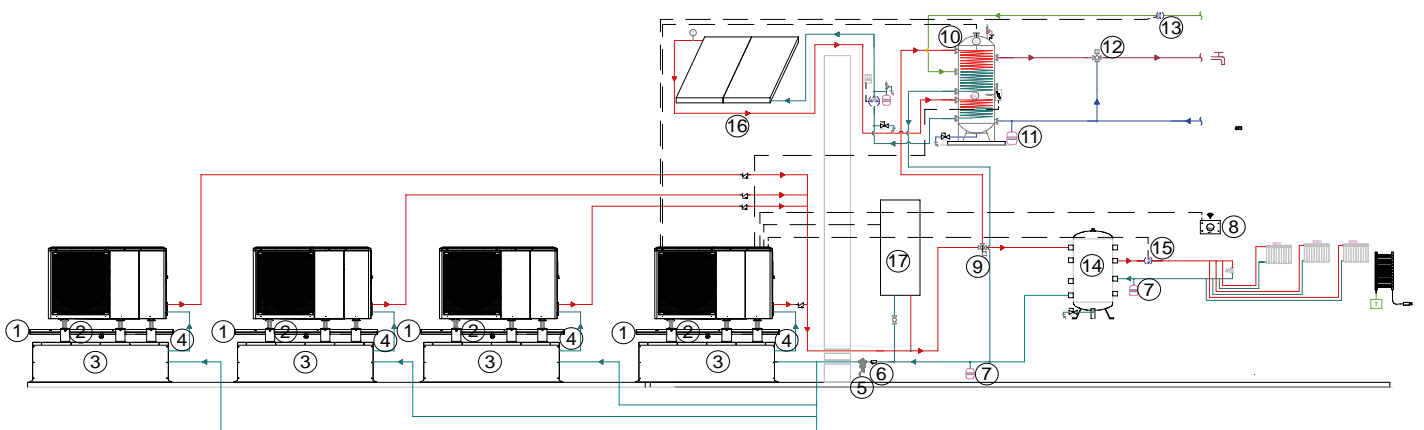

- 1 - DTX: Drain pan with electric heater
- 2 - ASTFX: Kit of antivibration mounts for installation on wall brackets, inertial storage tank or tray
- 3 - TANKX: system's inertial storage tank
- 4 - KTCAX: Hose kit for connecting the unit to the inertial storage tank
- 5 - FDMX: Magnetic dirt separator filter for water distribution systems
- 6 - mesh filter (supplied as standard with the unit)
- 7 - additional expansion tank (externally supplied)
- 8 - HID-TCXNX: white HID-TConnect chronothermostat
- 9 - 3DHWX: 3-way system/DHW switching valve

- 10 - ACS300X: DHW boiler / T1BX: DHW temperature probe / QERAX: Connection kit for heater on DHW storage tank
- 11 - DHW expansion tank (externally supplied)
- 12 - anti-scalding valve
- 13 - PRSX: DHW recirculation pump
- 14 - DH100X: 100-litre hydraulic circuit breaker
- 15 - PCS2X: oversized pump for secondary circuit
- 16 - ELFOsun solar thermal circuit
- 17 - GAS BOILER: boiler for centralised systems

Protections for unit and water circuit

Protection of the valves against blocking

Some system configurations require the system to operate for long periods in only one mode, e.g. Heating without switching to DHW. A typical scenario is when the system is equipped with a solar thermal circuit or boiler coupling.

In this case, the valves of the system can remain in a fixed position for a long time and become mechanically blocked. The unit is equipped with a protection that acts automatically: a safety cycle opens all the connected and enabled valves (SV1, SV2, SV3) should they remain closed for more than 24 hours.

The standard opening time is defined and can be adjusted at the HMI (*standard: 5 - can be set from: 0 to 60*).

Protection of the water circuit against freezing

The unit can operate at outdoor air temperatures $T4 < 0\text{ }^{\circ}\text{C}$, but there is a risk of formation of ice in both the water circuit and the source-side refrigerant-air exchanger. The unit continuously monitors the outdoor air temperature $T4$, the supply (T_{wout}) and return (T_{win}) water temperatures, and the refrigeration circuit parameters (evaporation and condensation pressures and temperatures).

The unit's logic provides for antifreeze protection and automatic defrosting, while additional protections can be provided in the design phase

Antifreeze protections

Even when the system is switched off, the antifreeze protection is always active and prevents the system from freezing. The protections are triggered by the temperature of the outdoor air $T4$, supply water T_{wout} and return water T_{win} : below the limit values, the heat pump or the additional electric heater is activated until the safety temperatures are reached.

STEP 1: the pumps of the unit and secondary pumps run cycles, with activation logic as shown.

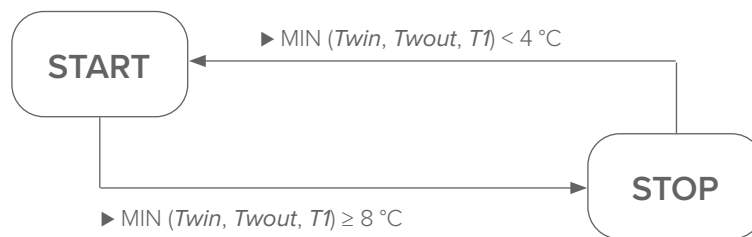

Note: the protection can be activated 2 to 30 seconds after the compressor has been switched off. After this time, the unit switches to the antifreeze protection logic of STEP 2.

STEP 2: unit pump, secondary pump and compressor (and any auxiliary heat source IBH or AHS) run cycles, with activation logic as shown.

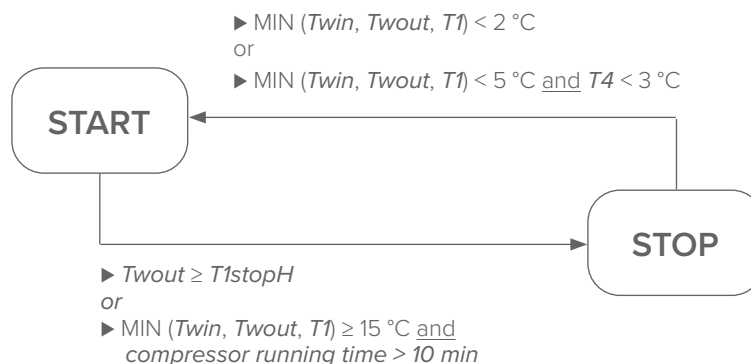

Note: the protection is in operation during periods of stand-by as well.
During step 2, the logic prioritises activation of auxiliary heat sources over the compressor

User-side heat exchanger protection: the plate heat exchanger is equipped with an integrated heater. Its setting in Heating / DHW / Stand-by mode is:

1. Activation: $-4\text{ }^{\circ}\text{C} \leq T4 < 3\text{ }^{\circ}\text{C}$ and $\text{MIN}(T_{win}, T_{wout}) < 5\text{ }^{\circ}\text{C}$ for 5 seconds
Deactivation: $T4 \geq 5\text{ }^{\circ}\text{C}$ e $\text{MIN}(T_{win}, T_{wout}) \geq 10\text{ }^{\circ}\text{C}$
2. Activation/deactivation cycles of 30 minutes: $-15\text{ }^{\circ}\text{C} \leq T4 < -4\text{ }^{\circ}\text{C}$ and $\text{MIN}(T_{win}, T_{wout}) \geq 5\text{ }^{\circ}\text{C}$
3. Continuous activation: $T4 < -15\text{ }^{\circ}\text{C}$

Protections for unit and water circuit

Its setting in Cooling mode is:

1. Activation: if between 2 and 30min after compressor switch-off MIN (Twin,Twout) < 4 °C for 5 seconds
Deactivation: MIN (Twin,Twout) ≥ 10 °C

Note: after 30min the logic switches to stand-by mode

Automatic defrosting

During operation in Heating or DHW mode, the unit manages intelligent defrosting cycles of the source-side exchanger with this series of actions:

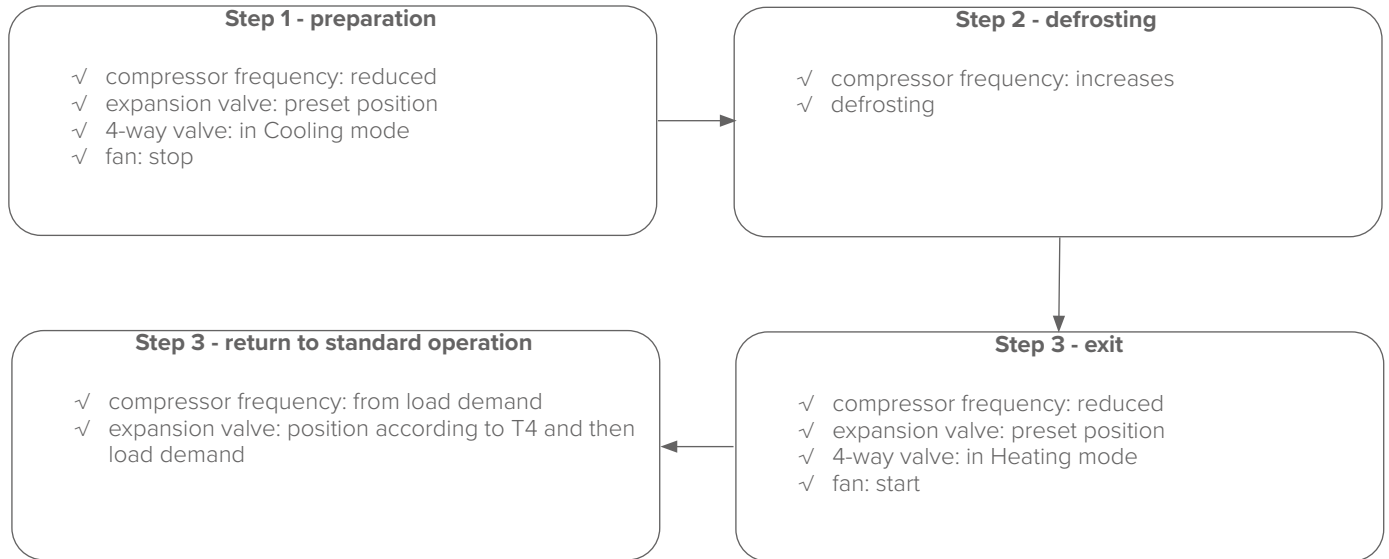

To manage defrosting, the unit monitors the progress of several parameters:

- T3: temperature of the source-side exchanger
- T3o: parameter related to the minimum temperature measured on the source-side heat exchanger in a time interval
- Time1: cumulative running time of compressor in Heating mode (timer starts when compressor runs in Heating mode and T3 < 0 °C, and is stopped when T3 > 14 °C or defrosting starts)
- Time2: continuous running time of compressor in Heating mode (timer starts when compressor runs in Heating mode, and is stopped when the compressor stops, T3 > 14 °C or defrosting starts)

The unit enters defrosting mode when Time2 ≥ 6min and if one of these cases occurs simultaneously:

1. Time1 ≥ 35min, T3 ≤ -1 °C and a time of 50 to 600s elapses between each 1 °C decrease in T3
2. Time1 ≥ 150min
3. different pre-set simultaneous conditions related to water supply temperature Twout, outdoor air temperature T4, Time1, T3 and T3o

The unit exits defrosting mode when one of these conditions occurs:

- defrosting time reaches 10min
- T3 ≥ 12 °C or T3 > 8 °C for 10s
- Twout < 10 °C for 5s and T3 > 5 °C

Additional protections

For additional protection, if it is foreseen during the design phase that the unit may often operate at outdoor air temperatures below 0 °C, it is advisable to install frost protection valves for draining the system (*accessory to be selected separately*) or to add glycol to the system water to lower its freezing temperature.

A generic system can use ethylene glycol or propylene glycol (category III according to EN1717, with inhibitors), while systems with DHW storage tank require only propylene glycol.

Depending on the minimum expected outdoor temperature, put a concentration of glycol into the water circuit as per the tables below.

The use of glycol changes performance of the unit: the operating performance can be estimated by multiplying the correction factors by the nominal operating values.

Table for ethylene glycol

MIN outdoor temperature	Glycol concentration	Correction factors			
		Cooling capacity	Power input	Water resistance	Water flow
0 °C	0%	1	1	1	1
-5 °C	10%	0.984	0.998	1.118	1.019
-15 °C	20%	0.973	0.995	1.268	1.051
-25 °C	30%	0.965	0.992	1.482	1.092

Protections for unit and water circuit

Table for propylene glycol

MIN outdoor temperature	Glycol concentration	Correction factors			
		Cooling capacity	Power input	Water resistance	Water flow
0 °C	0%	1	1	1	1
-4 °C	10%	0.976	0.996	1.071	1
-12 °C	20%	0.961	0.992	1.189	1.016
-20 °C	30%	0.948	0.988	1.380	1.034

⚠ The glycol concentration must never be > 30%. Do not install antifreeze valves if glycol is present.

Return of the oil

The unit has an *oil return time counter* with which it manages an oil return cycle where the expansion valve, fan and compressor are forced to run under particular operating conditions. During the cycle and for the next 4 minutes, the unit does not do the low pressure check. The timer is activated when the unit is not defrosting and the compressor is running below a certain frequency (excluding the start-up period). The timer resets when the unit activates the oil return cycle or is in an equivalent operating condition (compressor and expansion valve).

The activation logic of the cycle is as follows:

⚠ If a defrosting cycle is to be activated during an oil return cycle, the unit gives priority to the latter. If the timer exceeds 5hr 40min during a defrosting cycle, the unit waits for this

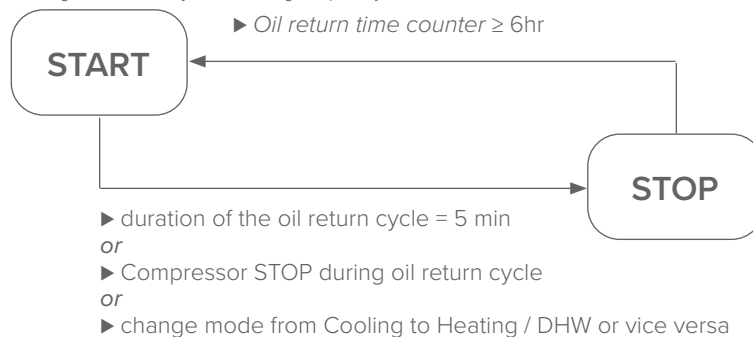

to be completed and 30min later starts the oil return cycle.

Compressor protections

The unit logic also includes various protections for the compressor.

- A minimum safety time of 5 min must elapse between switching the compressor off and on again
- At start-up, depending on the outdoor air temperature T4, the compressor runs at a preset frequency for a preset time. It then increases the frequency in increments until the target operating frequency is reached.
- During operation at low outdoor air temperatures T4 in Heating / DHW mode, the compressor has two additional protections. Starting of the compressor is facilitated by the casing heater (2 x 20W):
 - Unit in stand-by: $T4 \leq 8\text{ °C}$
 - Unit running: compressor stopped for more than 3 hours and $T4 \leq 8\text{ °C}$
Its deactivation is at compressor start-up, if $T4 > 8\text{ °C}$.
- The unit is equipped with multi-stage compressor discharge temperature protection to prevent too high a pressure in the refrigeration circuit.

Pressure in the refrigeration circuit

The unit is equipped with calibrated pressure switches to protect against high and low pressure in the refrigeration circuit, which stop the compressor 5 minutes after their intervention. Their intervention is dependent on the outdoor air temperature T4:

- $T4 \geq 0\text{ °C}$: standard protection
- $T4 = -1\text{ to }-7\text{ °C}$: protections are not active for the first 5 minutes after compressor activation
- $T4 \leq -8\text{ °C}$: low-pressure protection disabled "awaiting confirmation from TEC"

The logic is:

- the high-pressure switch trips at 4.3 MPa and resets at 3.6 MPa (3.2 MPa for sizes 9.1 to 14.1)
- the low-pressure switch trips at 0.14 MPa and resets at 0.3 MPa

⚠ Low pressure protection is not active during and up to 4 minutes after the end of the defrosting and oil return cycles

In order to prevent the continuous tripping of pressure switches, the unit's software control involves a series of actions dictated by pre-alarm thresholds that act on the components to try to prevent alarm lockout.

The unit is equipped with protections against abnormal operation of current or supply voltage.

Overcurrent protection: monitors the input current to the unit, comparing it with a set of predefined parameters (called A0-A1-A2-A3) that can be chosen from 8 standard sets at the HMI. The protection has different levels of intervention, with progressive increase in protection according to the logic:

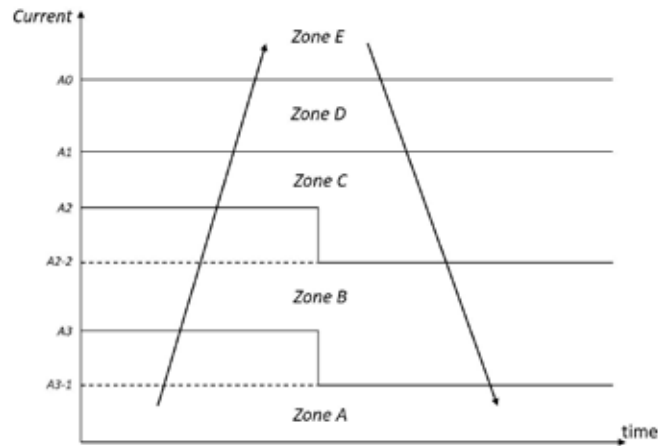

- Zone A: standard operation
- Zone B: if the compressor is operating above a frequency limit, any further increase in frequency is severely slowed down
- Zone C: the compressor can only decrease its frequency
- Zone D: forcibly decreases compressor frequency
- Zone E: stops the compressor and puts the unit in alarm mode

According to the factory parameters, the protection locks the unit when the currents are equal to parameter A0:

SIZE	2.1 TO 3.1	4.1 TO 5.1	6.1 TO 8.1	6.1T TO 8.1T	9.1	10.1	12.1	14.1
A0	18A	19A	30A	14A	18A	21A	24A	28A

Abnormal voltage protections: the unit monitors the input voltage of the unit and intervenes if it is too low or too high. In particular:

- single-phase overvoltage: the unit is switched off and put in alarm mode if voltage $\geq 265V$ is detected for 30 seconds, and is switched on again when voltage $< 256V$ for 30 seconds
- single-phase undervoltage: the unit is switched off and put in alarm mode if voltage $\leq 172V$ is detected, and is switched on again when voltage $> 180V$
- three-phase overvoltage: the unit is switched off and put in alarm mode if voltage $\geq 457V$ is detected for 30 seconds, and is switched on again when voltage $< 440V$ for 30 seconds
- three-phase undervoltage: the unit is switched off and put in alarm mode if voltage $\leq 298V$ is detected, and is switched on again when voltage $> 312V$

When the voltage is below 200V (for each phase in the case of three-phase versions), the compressor is limited according to the logic:

- Zone A: unit shutdown and alarm
- Zone B: compressor frequency strongly limited

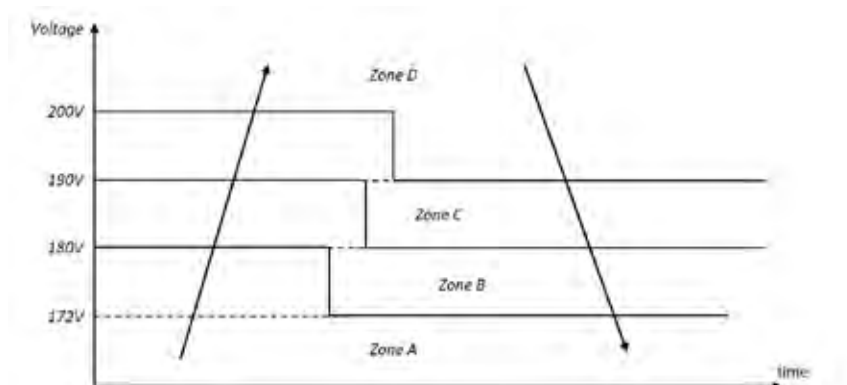

- Zone C: compressor frequency slightly limited
- Zone D: normal compressor operation

Factory code	Date	Revision
16025300A16124	2022.03.31	C

THE FAULT OR PROTECTION TABLE	
Display	Meltdown or Protection
L0	Module protection/heat pump system
L1	DC generator low voltage protection
L2	DC generator high voltage protection
L3	DC generator low pressure protection
L4	MCE malfunction
L5	Zero speed protection
L7	Phase sequence protection
L8	Speed difference >15% protection between the front and the back clock
L9	Speed difference >15% protection between the real and the setting speed
P0	Low pressure switch protection
P1	High pressure protection
P2	Compressor overcurrent protection
P3	Compressor overcurrent protection
P4	Comp. charge temp. too high protection
P6	Transducer module (PM) protection
P9	DC fan motor protection
Pd	DC fan motor protection
h0	Temperature sensor
h1	Temperature sensor
h2	Temperature sensor
h3	Temperature sensor
h4	Temperature sensor
h5	Temperature sensor
h6	Temperature sensor
h7	Temperature sensor
h8	Temperature sensor
h9	Temperature sensor
h10	Temperature sensor
h11	Temperature sensor
h12	Temperature sensor
h13	Temperature sensor
h14	Temperature sensor
h15	Temperature sensor
h16	Temperature sensor
h17	Temperature sensor
h18	Temperature sensor
h19	Temperature sensor
h20	Temperature sensor
h21	Temperature sensor
h22	Temperature sensor
h23	Temperature sensor
h24	Temperature sensor
h25	Temperature sensor
h26	Temperature sensor
h27	Temperature sensor
h28	Temperature sensor
h29	Temperature sensor
h30	Temperature sensor
h31	Temperature sensor
h32	Temperature sensor
h33	Temperature sensor
h34	Temperature sensor
h35	Temperature sensor
h36	Temperature sensor
h37	Temperature sensor
h38	Temperature sensor
h39	Temperature sensor
h40	Temperature sensor
h41	Temperature sensor
h42	Temperature sensor
h43	Temperature sensor
h44	Temperature sensor
h45	Temperature sensor
h46	Temperature sensor
h47	Temperature sensor
h48	Temperature sensor
h49	Temperature sensor
h50	Temperature sensor
h51	Temperature sensor
h52	Temperature sensor
h53	Temperature sensor
h54	Temperature sensor
h55	Temperature sensor
h56	Temperature sensor
h57	Temperature sensor
h58	Temperature sensor
h59	Temperature sensor
h60	Temperature sensor
h61	Temperature sensor
h62	Temperature sensor
h63	Temperature sensor
h64	Temperature sensor
h65	Temperature sensor
h66	Temperature sensor
h67	Temperature sensor
h68	Temperature sensor
h69	Temperature sensor
h70	Temperature sensor
h71	Temperature sensor
h72	Temperature sensor
h73	Temperature sensor
h74	Temperature sensor
h75	Temperature sensor
h76	Temperature sensor
h77	Temperature sensor
h78	Temperature sensor
h79	Temperature sensor
h80	Temperature sensor
h81	Temperature sensor
h82	Temperature sensor
h83	Temperature sensor
h84	Temperature sensor
h85	Temperature sensor
h86	Temperature sensor
h87	Temperature sensor
h88	Temperature sensor
h89	Temperature sensor
h90	Temperature sensor
h91	Temperature sensor
h92	Temperature sensor
h93	Temperature sensor
h94	Temperature sensor
h95	Temperature sensor
h96	Temperature sensor
h97	Temperature sensor
h98	Temperature sensor
h99	Temperature sensor
h100	Temperature sensor

Code	Parameter	Value	Unit
S5-1S5-2S5-3	Factory setting	mono	
S6-1S6-2S6-3	Factory setting	split	
12kW	Power	0	0
14kW	Power	1	0
16kW	Power	0	1

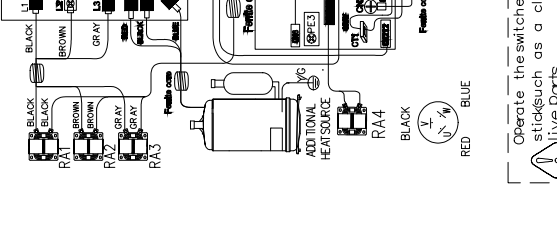
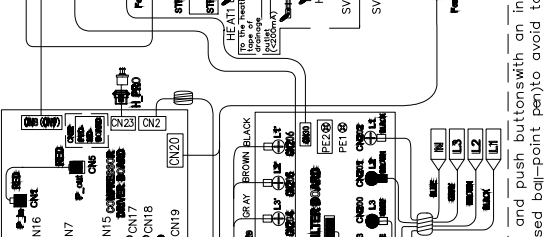
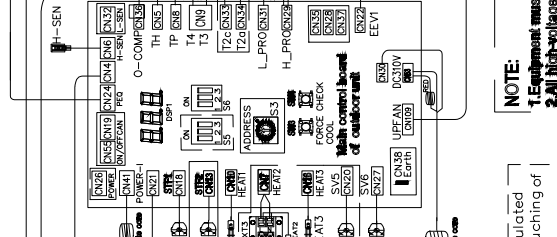
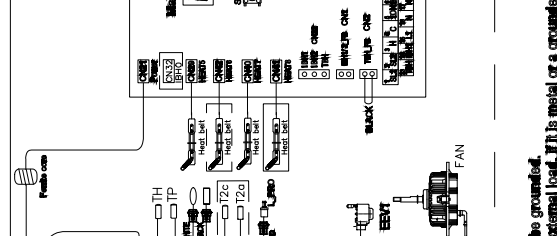
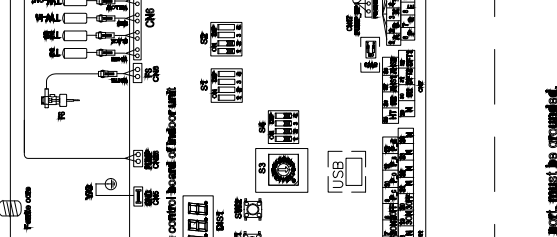
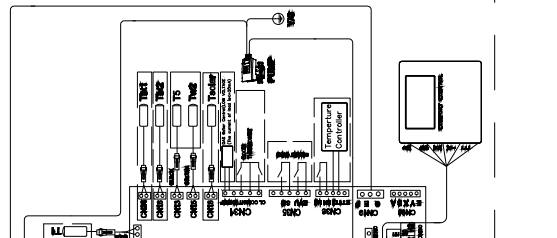

Code	Parameter	Value	Unit
S5-1S5-2S5-3	Factory setting	mono	
S6-1S6-2S6-3	Factory setting	split	
12kW	Power	0	0
14kW	Power	1	0
16kW	Power	0	1

Code	Parameter	Value	Unit
T3/4/h	Temp. sensor code	B _{25/25} = 4100K, R ₂₅ = 10KΩ	
TP	Temp. sensor code	B _{25/25} = 3950K, R ₂₅ = 5KΩ	

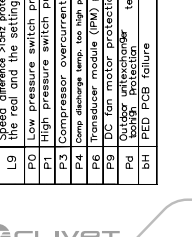
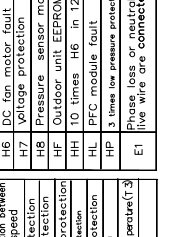
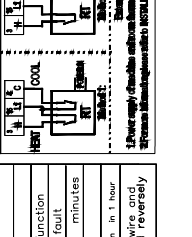
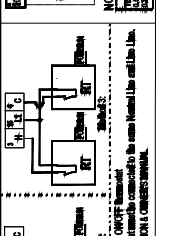
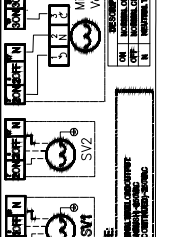
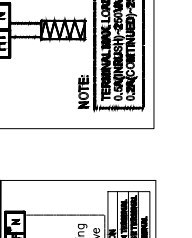
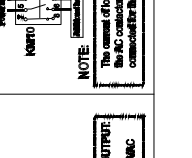
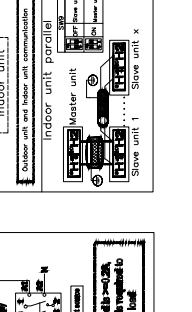
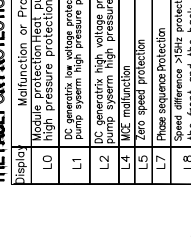
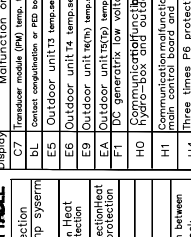
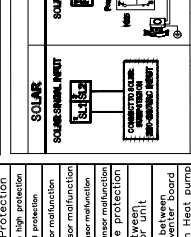
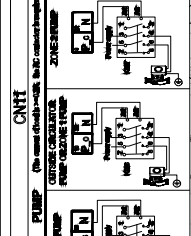
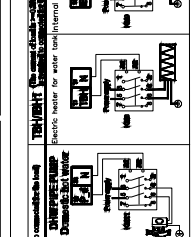
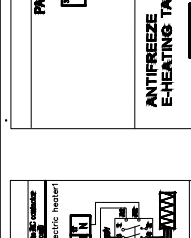
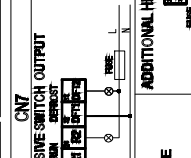
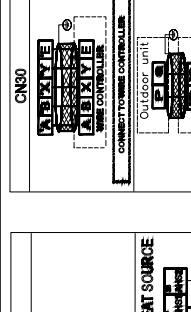
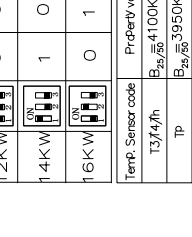
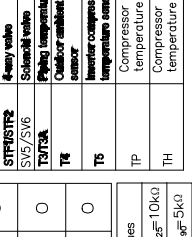
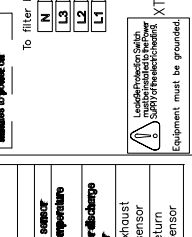
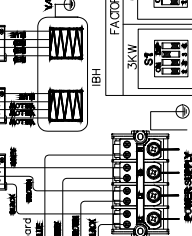
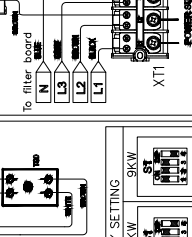
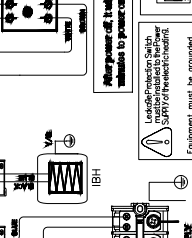
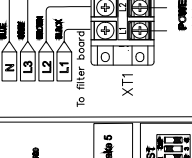
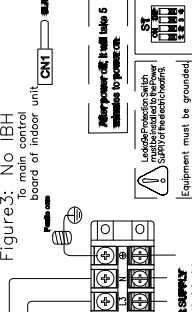
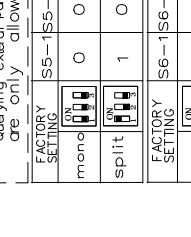
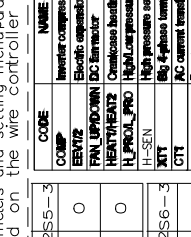
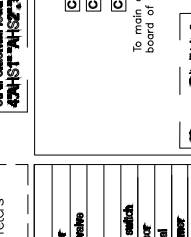
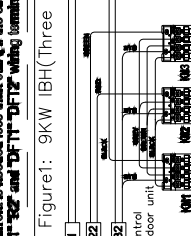
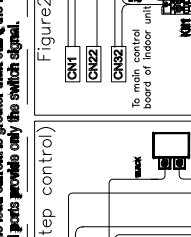
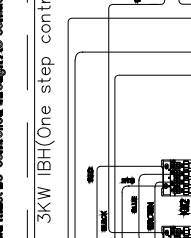

NOTE:
1. Equipment must be grounded.
2. All high-voltage external load, if it is metal or a grounded part, must be grounded.
3. All external load current is needed less than 0.2A. If the single load current is greater than 0.2A, the load must be controlled through AC contactor.
4. PH1~PH3, RT~RT2 and DT1~DT2 wiring terminal pins provide only the switch signal.

NOTE:
1. Equipment must be grounded.
2. All high-voltage external load, if it is metal or a grounded part, must be grounded.
3. All external load current is needed less than 0.2A. If the single load current is greater than 0.2A, the load must be controlled through AC contactor.
4. PH1~PH3, RT~RT2 and DT1~DT2 wiring terminal pins provide only the switch signal.

NOTE:
1. Equipment must be grounded.
2. All high-voltage external load, if it is metal or a grounded part, must be grounded.
3. All external load current is needed less than 0.2A. If the single load current is greater than 0.2A, the load must be controlled through AC contactor.
4. PH1~PH3, RT~RT2 and DT1~DT2 wiring terminal pins provide only the switch signal.

NOTE:
1. Equipment must be grounded.
2. All high-voltage external load, if it is metal or a grounded part, must be grounded.
3. All external load current is needed less than 0.2A. If the single load current is greater than 0.2A, the load must be controlled through AC contactor.
4. PH1~PH3, RT~RT2 and DT1~DT2 wiring terminal pins provide only the switch signal.

NOTE:
1. Equipment must be grounded.
2. All high-voltage external load, if it is metal or a grounded part, must be grounded.
3. All external load current is needed less than 0.2A. If the single load current is greater than 0.2A, the load must be controlled through AC contactor.
4. PH1~PH3, RT~RT2 and DT1~DT2 wiring terminal pins provide only the switch signal.

NOTE:
1. Equipment must be grounded.
2. All high-voltage external load, if it is metal or a grounded part, must be grounded.
3. All external load current is needed less than 0.2A. If the single load current is greater than 0.2A, the load must be controlled through AC contactor.
4. PH1~PH3, RT~RT2 and DT1~DT2 wiring terminal pins provide only the switch signal.

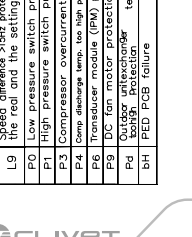
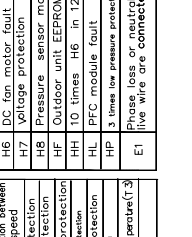
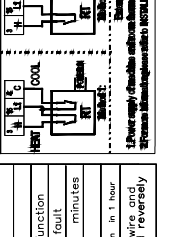
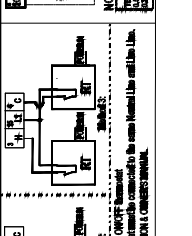
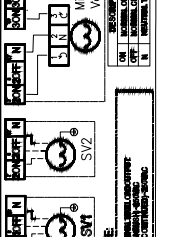
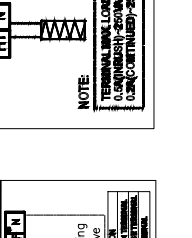
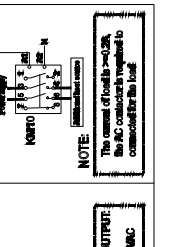
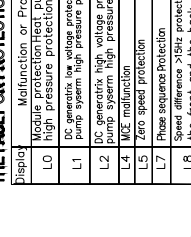
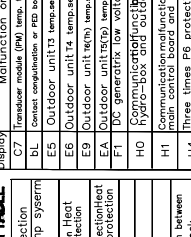
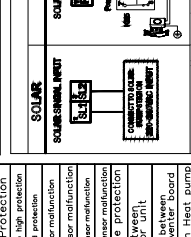
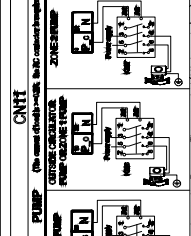
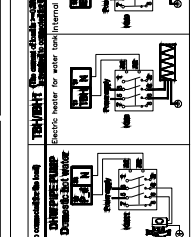
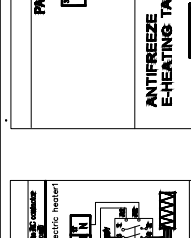
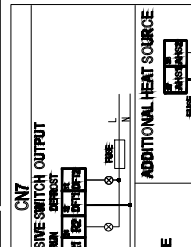

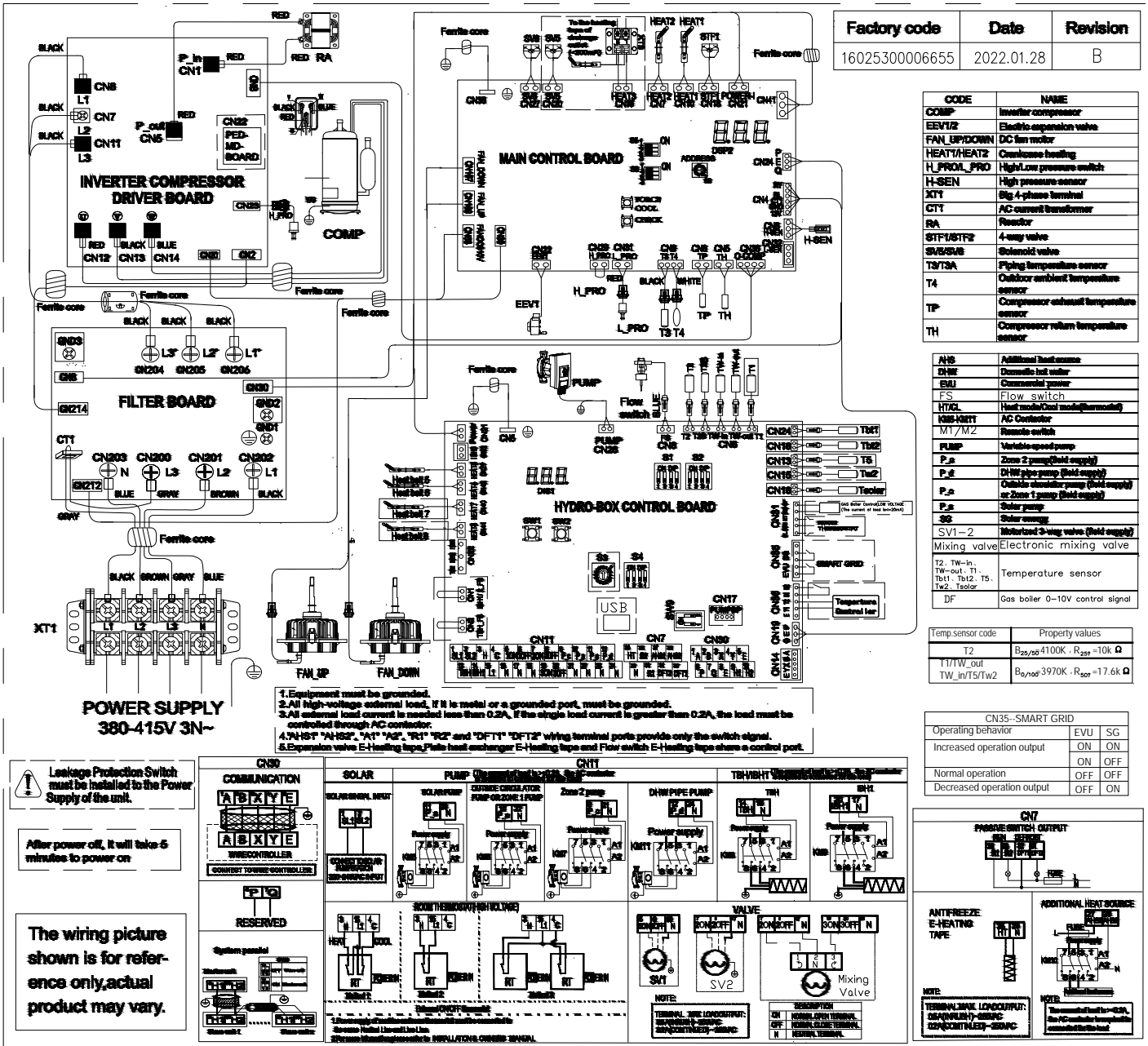

Factory code	Date	Revision
16025300006655	2022.01.28	B

CODE	NAME
COMP	Inverter compressor
EEV1/2	Electric expansion valve
FAN_UP/DOWN	DC fan motor
HEAT1/HEAT2	Outdoor heating
H_PRO1_HPRO	High/Low pressure switch
H-SEN	High pressure sensor
XT1	Big 4-phase terminal
CT1	AC current transformer
RA	Resistor
STF1/ST2	4-way valve
SV1/2	3-way valve
T2/T3	Temperature sensor
T4	Outdoor ambient temperature sensor
TP	Compressor ambient temperature sensor
TH	Compressor return temperature sensor

ANS	Additional functions
ENHE	Emergency hot water
FS	Flow switch
HT/CL	Hot water/cool media (intermittent)
KB-MIXT	AC Controller
M1/M2	Remote switch
PUMP	Variable-speed pump
P.2	Zone 2 pump (hold supply)
P.3	DHW pipe pump (hold supply)
P.4	Outdoor shower pump (hold supply) or Zone 1 pump (hold supply)
P.5	Water pump
SS	Water sensor
SV1-2	Multistage 3-way valve (hold supply)
Mixing valve	Electronic mixing valve
T2, TW-in, TW-out, T1, TH1, TH2, T5, TW2	Temperature sensor
DF	Gas boiler 0-10V control signal

Temp. sensor code	Property values
T2	$B_{25/25} 4100K \cdot R_{25} = 10k \Omega$
T1/TW_out TW_in/T5/TW2	$B_{25/25} 3970K \cdot R_{25} = 17.6k \Omega$

CN35 - SMART GRID		
Operating behavior	EVU	SG
Increased operation output	ON	ON
Normal operation	ON	OFF
Decreased operation output	OFF	OFF

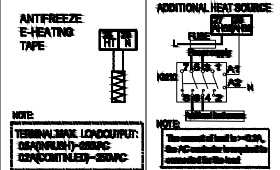
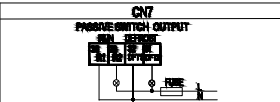

Leakage Protection Switch must be installed to the Power Supply of the unit.

After power off, it will take 5 minutes to power on

The wiring picture shown is for reference only, actual product may vary.

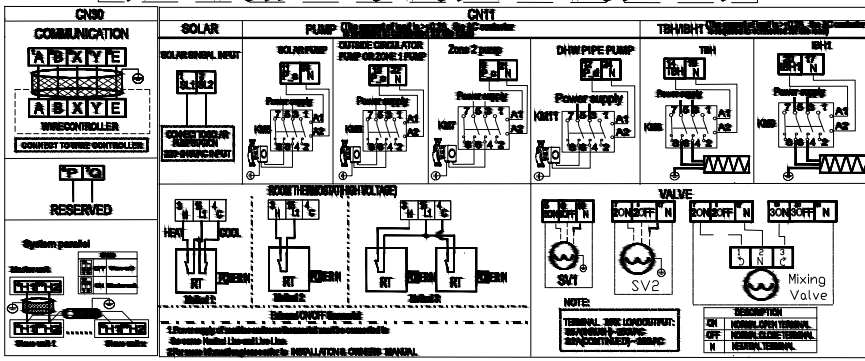

Page intentionally left blank

Page intentionally left blank

Page intentionally left blank

FOR OVER 30 YEARS WE HAVE BEEN
OFFERING SOLUTIONS TO ENSURE
SUSTAINABLE COMFORT AND THE WELL-
BEING OF PEOPLE AND THE ENVIRONMENT

www.clivet.com

MideaGroup
Humanizing Technology

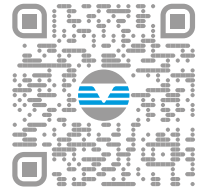

sale and assistance

Edge EVO 2.0 - EXC - WISAN-YME 1 S 2.1-14.1 - BT22D0039GB-02



CLIVET S.p.A.

Via Camp Lonc 25, Z.I. Villapaiera
32032 Feltre (BL) - Italy
Tel. +39 0439 3131 - info@clivet.it

CLIVET GMBH

Hummelsbütteler Steindamm 84,
22851 Norderstedt, Germany
Tel. +49 40 325957-0 - info.de@clivet.com

Clivet Group UK LTD

Units F5 & F6 Railway Triangle,
Portsmouth, Hampshire PO6 1TG
Tel. +44 02392 381235 -
Enquiries@Clivetgroup.co.uk

CLIVET LLC

Office 508-511, Elektrozavodskaya st. 24,
Moscow, Russian Federation, 107023
Tel. +7495 6462009 - info.ru@clivet.com

CLIVET MIDEAST FZCO

Dubai Silicon Oasis (DSO) Headquarter Building,
Office EG-05, P.O Box-342009,
Dubai, UAE
Tel.+971 (0) 4501 5840- info@clivet.ae

Clivet South East Europe

Jarušćica 9b
10000, Zagreb, Croatia
Tel. +385916065691 - info.see@clivet.com

Clivet Airconditioning Systems Pvt Ltd

Office No.501 & 502,5th Floor, Commercial -I,
Kohinoor City, Old Premier Compound, Off
LBS Marg, Kiroi Road, Kurla West, Mumbai
Maharashtra 400070, India
Tel. +91 22 30930200 - sales.india@clivet.com