

**SPLIT TYPE
ROOM AIR CONDITIONER
WALL MOUNTED^{type}
INVERTER**

SERVICE INSTRUCTION

Models	Indoor unit	Outdoor unit
	AS* G09LECB	AO* G09LECAN
	AS* G12LECB	AO* G12LECAN

Refrigerant
R410A

CONTENTS

1. DESCRIPTION OF EACH CONTROL OPERATION

1. COOLING OPERATION.....	01-01
2. HEATING OPERATION.....	01-02
3. DRY OPERATION.....	01-03
4. AUTO CHANGEOVER OPERATION.....	01-04
5. INDOOR FAN CONTROL.....	01-05
6. OUTDOOR FAN CONTROL.....	01-07
7. LOUVER CONTROL.....	01-08
8. COMPRESSOR CONTROL.....	01-09
9. TIMER OPERATION CONTROL.....	01-10
10. ELECTRONIC EXPANSION VALVE CONTROL.....	01-13
11. TEST OPERATION CONTROL.....	01-13
12. PREVENT TO RESTART FOR 3 MINUTES (3 MINUTES ST).....	01-13
13. FOUR-WAY VALVE EXTENSION SELECT.....	01-13
14. AUTO RESTART.....	01-13
15. MANUAL AUTO OPERATION (Indoor unit body operation).....	01-14
16. FORCED COOLING OPERATION.....	01-14
17. COMPRESSOR PREHEATING.....	01-14
18. 10°C HEAT OPERATION.....	01-15
19. ECONOMY OPERATION.....	01-15
20. BASE HEATER OPERATION.....	01-15
21. DEFROST OPERATION CONTROL.....	01-16
22. OFF DEFROST OPERATION CONTROL.....	01-18
23. VARIOUS PROTECTIONS.....	01-19

2. TROUBLE SHOOTING

2-1 ERROR DISPLAY.....	02-01
2-1-1 INDOOR UNIT AND WIRED RMOTE CONTROLLER DISPLAY (OPTION).....	02-01
2-1-2 WIRED REMOTE CONTROLLER DISPLAY (OPTION).....	02-02
2-2 TROUBLE SHOOTING WITH ERROR CODE.....	02-03
2-3 TROUBLE SHOOTING WITH NO ERROR CODE.....	02-24
2-4 SERVICE PARTS INFORMATION.....	02-29

3. APPENDING DATA

3-1 FUNCTION SETTING.....	03-01
3-1-1 INDOOR UNIT.....	03-01
3-1-2 Procedures to change the Function Setting for wireless RC.....	03-03
3-2 Thermistor Resistance Values.....	03-05

WALL MOUNTED type INVERTER

1 . DESCRIPTION OF EACH CONTROL OPERATION

1. COOLING OPERATION

1-1 COOLING CAPACITY CONTROL

A sensor (room temperature thermistor) built in the indoor unit body will usually perceive difference or variation between a set temperature and present room temperature, and controls the operation speed of the compressor.

- * If the room temperature is 2°C higher than a set temperature, the compressor operation speed will attain to maximum performance.
- * If the room temperature is 2.5°C lower than a set temperature, the compressor will be stopped.
- * When the room temperature is between +2°C to -2.5°C of the setting temperature, the compressor speed is controlled within the range shown in Table1. However, the maximum speed is limited in the range shown in Fig. 1 based on the fan speed mode and the outdoor temperature.

(Table 1 : Compressor speed range)

	Minimum speed	Maximum speed II	Maximum speed I
AO*G09LECAN	18rps	62rps	64rps
AO*G12LECAN	18rps	80rps	96rps

When the compressor operates for 30 minutes continuously at over the maximum speed II, the maximum speed is changed from Maximum speed I to Maximum speed II.

(Fig. 1 : Limit of maximum speed based on outdoor temperature)

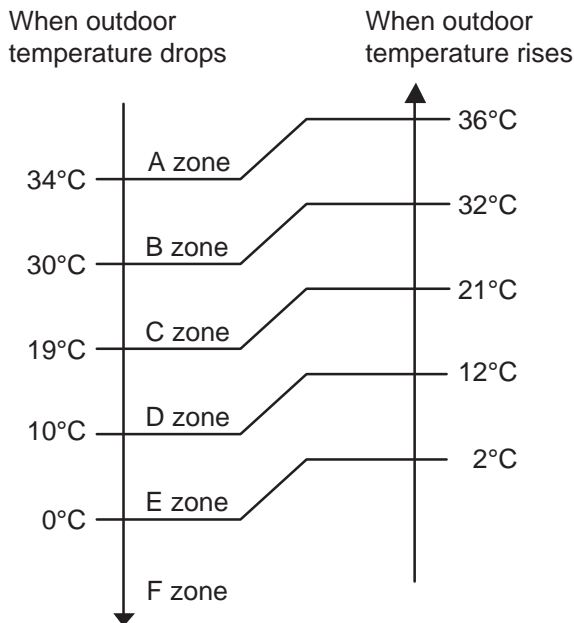

		Hi	Me	Lo	Quiet
09LECAN	A zone	64rps	50rps	42rps	30rps
	B zone	64rps	50rps	42rps	30rps
	C zone	64rps	50rps	42rps	30rps
	D zone	42rps	35rps	30rps	23rps
	E zone	52rps	45rps	40rps	29rps
	F zone	52rps	45rps	40rps	29rps
12LECAN	A zone	96rps	61rps	51rps	33rps
	B zone	96rps	61rps	51rps	33rps
	C zone	96rps	61rps	51rps	33rps
	D zone	57rps	42rps	36rps	27rps
	E zone	57rps	42rps	36rps	27rps
	F zone	57rps	42rps	36rps	27rps

2. HEATING OPERATION

2-1 HEATING CAPACITY CONTROL

A sensor (room temperature thermistor) built in the indoor unit body will usually perceive difference or variation between a set temperature and present room temperature, and controls the operation speed of the compressor.

- * If the room temperature is lower by 3°C than a set temperature, the compressor operation speed will attain to maximum performance.
- * If the room temperature is higher 2.5°C than a set temperature, the compressor will be stopped.
- * When the room temperature is between +2.5°C to -3°C of the setting temperature, the compressor speed is controlled within the range shown in Table2.

(Table 2 : Compressor speed range)

	Minimum speed	Maximum speed
AO*G09LECAN	18rps	119rps
AO*G12LECAN	18rps	130rps

3. DRY OPERATION

3-1 INDOOR UNIT CONTROL

The compressor rotation frequency shall change according to the temperature, set temperature, and room temperature variation which the room temperature sensor of the indoor unit body has detected as shown in the Table 3.

However, the compressor frequency after the start-up is 56rps for 80seconds.

(Table 3 : Compressor frequency)

		Operating speed			Operating speed
09LECAN	X zone	30rps	12LECAN	X zone	33rps
	J zone	23rps		J zone	25rps
	Y zone	0rps		Y zone	0rps

(Fig.2 : Compressor control based on room temperature)

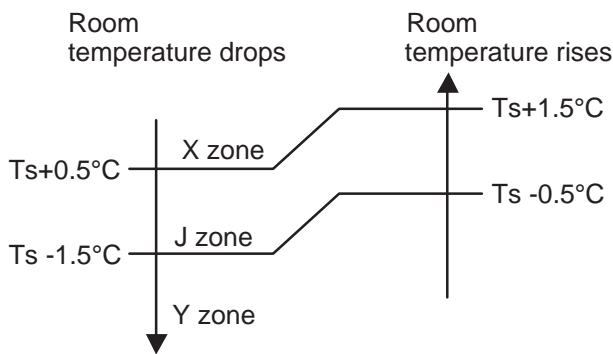

4. AUTO CHANGEOVER OPERATION

When the air conditioner is set to the AUTO mode by remote control, operation starts in the optimum mode from among the Heating, Cooling, Dry and Monitoring modes. During operation, the optimum mode is automatically switched in accordance with temperature changes.

The temperature can be set between 18°C and 30°C in 1°C steps.

(Fig. 3 : Operation flow chart in Auto changeover)

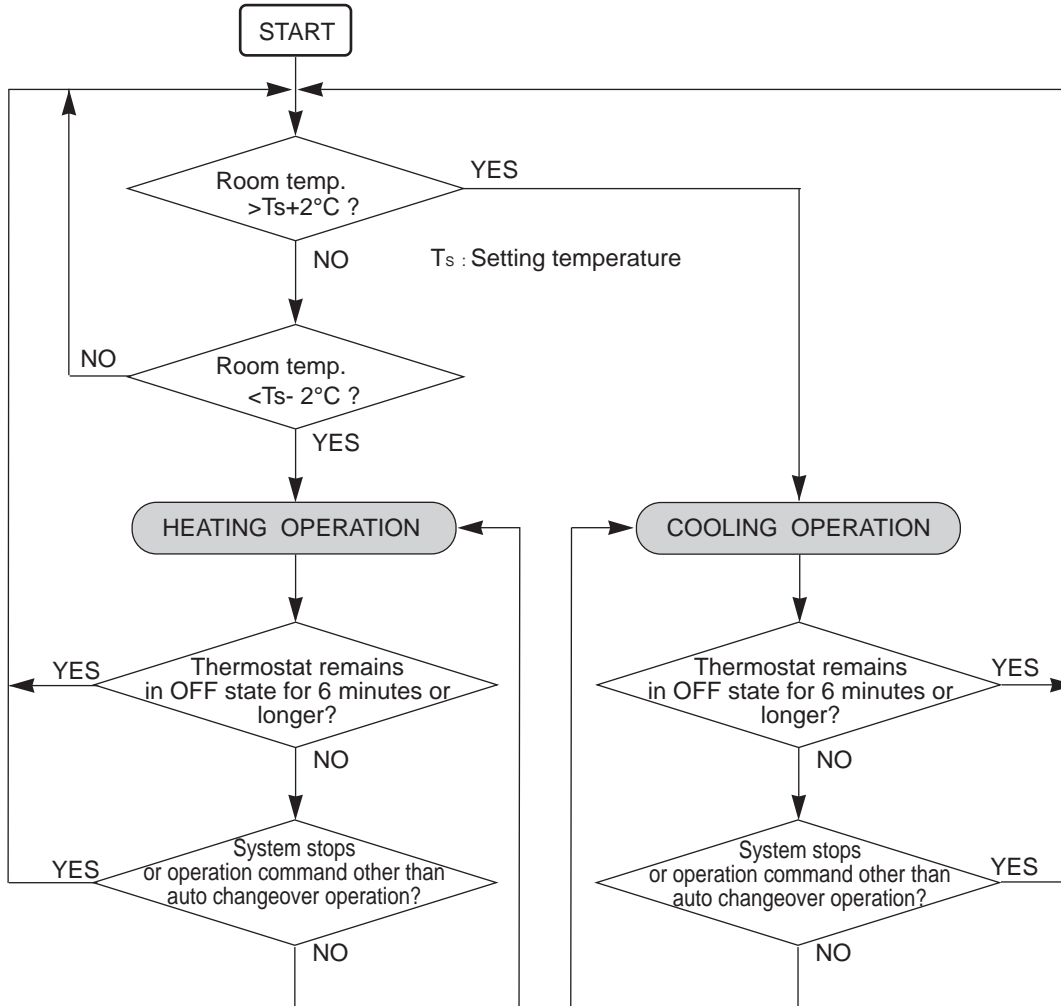

5. INDOOR FAN CONTROL

1. FAN SPEED

(Table 5 : Indoor fan speed)

• AS*G09/12LECB

Operation mode	Air flow mode	Speed (rpm)
Heating	Hi	1440
	Me+	1370
	Me	1200
	Lo	980
	Quiet	700
	Cool air prevention	600
	S-Lo	480
Cooling/ Fan	Hi	1440
	Me	1200
	Lo	920
	Quiet	680
	* Soft Quiet	600
Dry		X zone: 680 J zone: 600

*Note, during Economy operation and operation mode is Fan, air flow is 1 step downs.
(Hi > Me, Me > Lo, Lo > Quiet, Quiet > Soft Quiet)

2. FAN OPERATION

The airflow can be switched in 5 steps such as Auto, Quiet, Low, Med, Hi, while the indoor fan only runs. When Fan mode is set at [Auto], it operates on [Me] Fan Speed.

3. COOLING OPERATION

Switch the airflow [Auto], and the indoor fan motor will run according to a room temperature, as shown in Fig. 4. On the other hand, if switched in [Hi] ~ [Quiet], the indoor motor will run at a constant airflow of [Cool] operation modes Quiet, Lo, Me, Hi, as shown in Table 5.

(Fig.4 : Airflow change - over (Cooling : Auto))

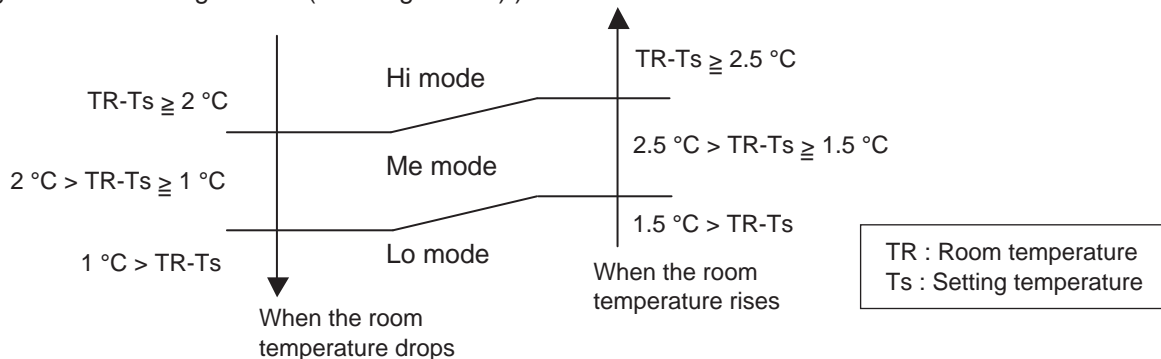

4. DRY OPERATION

Refer to the Table 5.

During the dry mode operation, the fan speed setting can not be changed.

5. HEATING OPERATION

Switch the airflow [Auto], and the indoor fan motor will run according to a room temperature, as shown in Fig. 5. On the other hand, if switched in [Hi] ~ [Quiet], the indoor motor will run at a constant airflow of [Heat] operation modes Quiet, Lo, Me, Hi, as shown in Table 5.

(Fig.5 : Airflow change - over (Heating : Auto))

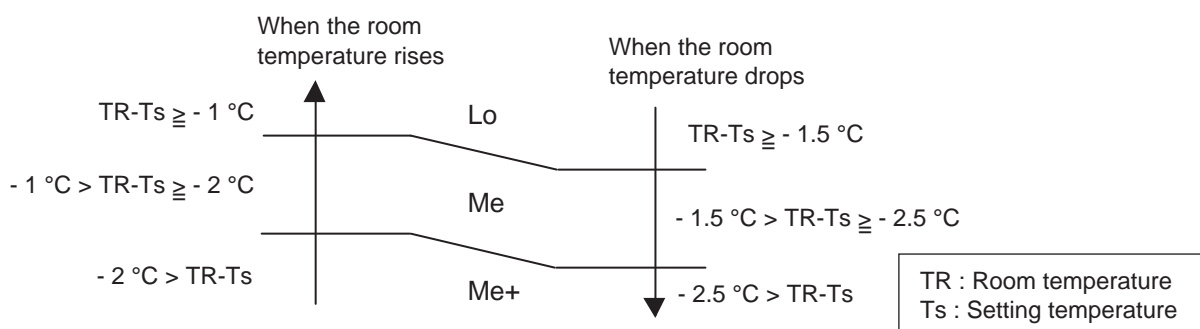

6. COOL AIR PREVENTION CONTROL (Heating mode)

The maximum value of the indoor fan speed is set as shown in Fig. 6, based on the detected temperature by the indoor heat exchanger sensor on heating mode.

(Fig.6 : Cool air prevention control)

<Before 7 minutes upon running the compressor>

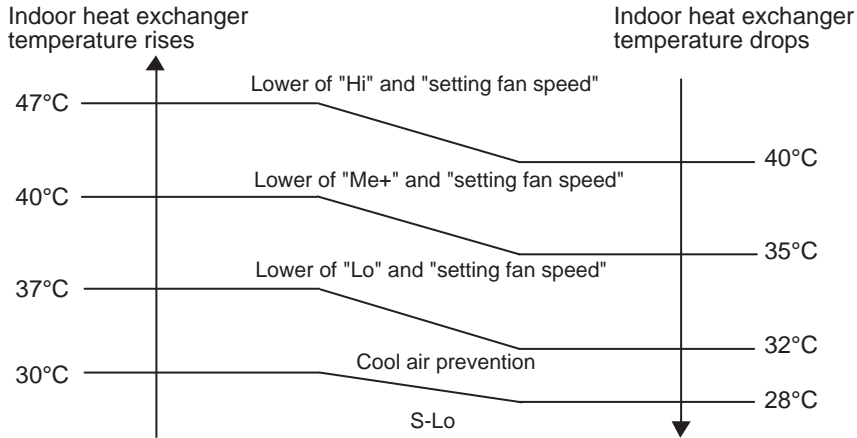

<After 7 minutes upon running the compressor>

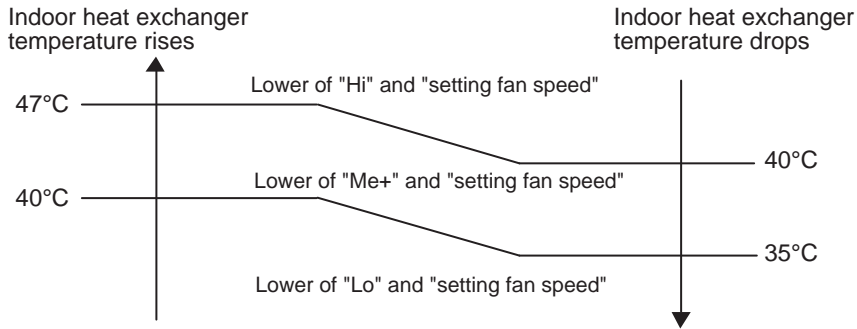

7. MOISTURE RETURN PREVENTION CONTROL (Cooling mode & Dry mode)

Switch the airflow [Auto] at cooling mode, and the indoor fan motor will run as shown in Fig.7.

(Fig.7 : Indoor fan control)

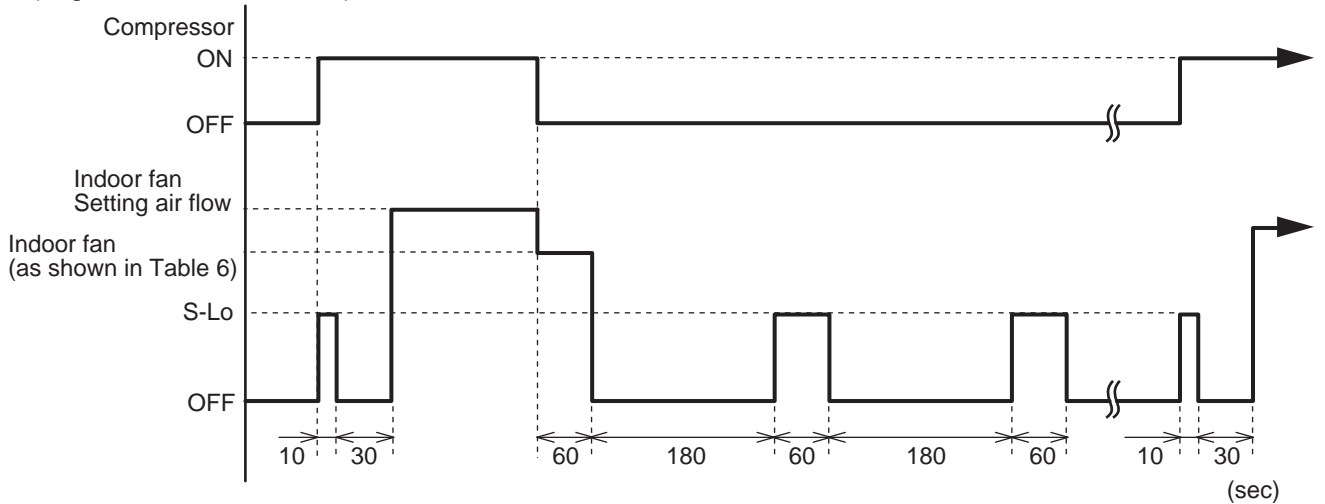

(Table 6 : Indoor fan speed)

	Dry			Cooling
	X zone	J zone	Y zone	
AS* G09/ 12LECB	680rpm	600rpm	0⇔480rpm	680rpm

6. OUTDOOR FAN CONTROL

1. Outdoor Fan Motor

Following table shows the type of the outdoor fan motor. The control method is different between AC motor and DC motor.

(Table7 : Type of Motor)

	AC Motor	DC Motor
AO*G09/ 12LECAN		○

2. Fan Speed

(Table8 : Outdoor fan speed)

	Zone ※	Cooling	Heating	Dry (rpm)
AO*G09LECAN	D	850/ 750/ 670/ 500	850/ 750/ 680/ 550/ 450	760/ 470
	F	230		230
	G	150		150
AO*G12LECAN	D	850/ 750/ 670/ 500	900/ 750/ 680/ 550/ 450	760/ 470
	F	330		330
	G	230/ 200		230/ 200

※ Refer to Fig.8

(Fig.8 : Outside air temperature zone selection)

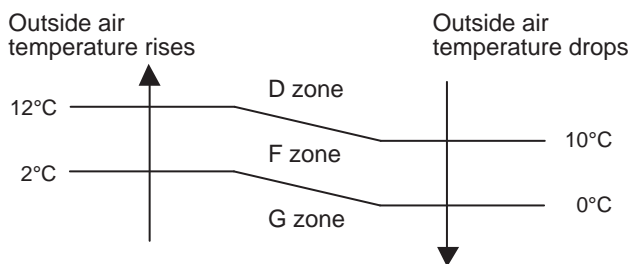

- * The outdoor fan speed mentioned above depends on the compressor frequency. (When the compressor frequency increases, the outdoor fan speed also changes to the higher speed. When the compressor frequency decreases, the outdoor fan speed also changes to the lower speed.)
- * After the defrost control is operated on the heating mode, the fan speed keeps at the higher speed as table9 without relating to the compressor frequency.

(Table9 : Outdoor fan speed after the defrost)

AO*G09LECAN	850rpm
AO*G12LECAN	900rpm

7. LOUVER CONTROL

1. VERTICAL LOUVER CONTROL

(Function Range)

Each time the button is pressed, the air direction range will change as follow:

① ⇄ ② ⇄ ③ ⇄ ④ ⇄ ⑤ ⇄ ⑥

(Fig 9: Air Direction Range)

(Operation Range)

①~⑥ Cooling / Dry mode / Heating mode / Fan mode

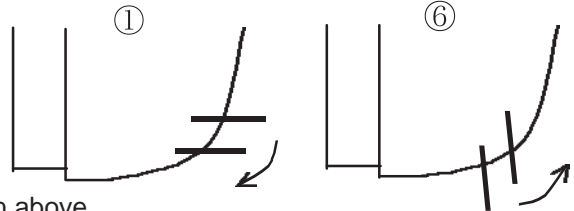

Use the air direction adjustments within the ranges shown above.

- The vertical airflow direction is set automatically as shown, in accordance with the type of operation selected.
 - Cooling / Dry mode : Horizontal flow ①
 - Heating mode : Downward flow ⑥
- When the temperature of the air being blown out is low at the start of heating operation or during defrosting, the airflow direction temporarily becomes ① to prevent cold air being blown onto the body.
- During use of the Cooling and Dry modes, do not set the Air Flow Direction Louver in the Heating range (④~⑥) for long period of time, since water vapor may condense near the outlet louvers and drop of water may drip from the air conditioner. During the Cooling and Dry modes, if the Air Flow Direction Louvers are left in the heating range for more than 30minutes, they will automatically return to position ③.
- During Monitor operation in AUTO CHANGEOVER mode, the airflow direction automatically becomes ①, and it cannot be adjusted.

2. SWING OPERATION

When the swing signal is received from the remote controller, the vertical louver starts to swing.

(Swinging Range)

Cooling mode / Dry mode / Fan mode(①~③) : ① ⇄ ③

Heating mode / Fan mode(④~⑥) : ③ ⇄ ⑥

- When the indoor fan is either at S-Lo or Stop mode, the swinging operation is interrupted and the louver stops at the memorized position.

8. COMPRESSOR CONTROL

1. OPERATION SPEED RANGE

The operation speed of the compressor is different based on the operation mode as shown in the Table 10.

(Table 10 : Compressor operation speed range)

	Cooling		Heating		Dry	
	Minimum	Maximum	Minimum	Maximum	Minimum	Maximum
AO*G09LECAN	18rps	64rps	18rps	119rps	23rps	30rps
AO*G12LECAN	18rps	96rps	18rps	130rps	25rps	33rps

2. OPERATION SPEED CONTROL AT START UP

The compressor speed soon after the start-up is controlled as shown in the Fig. 10.

(Fig.10 : Compressor control at start-up)

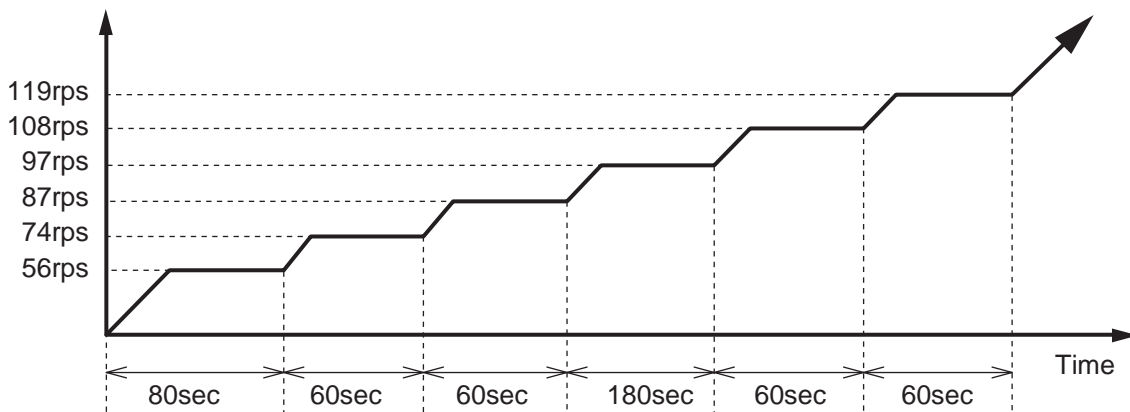

3. LIMITATION OF COMPRESSOR FREQUENCY BY OUTDOOR TEMPERATURE

The minimum compressor frequency is limited by outdoor temperature as shown in the Table11.

(Table11 : Limitation of Compressor Frequency)

[Cooling/ Dry]

	10°C		14°C		40°C	
	Under	Over	Under	Over	Under	Over
AO* G09/ 12LECAN	39rps	26rps	18rps	30rps		

[Heating]

	- 3°C		7°C		14°C		40°C	
	Under	Over	Under	Over	Under	Over	Under	Over
AO* G09/ 12LECAN	30rps	30rps	26rps	18rps	30rps			

9. TIMER OPEARTION CONTROL

9-1 WIRELESS REMOTE CONTROLLER

The Table 12 shows the available timer setting based on the product model.

(Table 12 : Timer setting)

	ON TIMER / OFF TIMER	PROGRAM TIMER	SLEEP TIMER
AS* G09/ 12LECB	○	○	○

1. OPEARTION FREQUENCY RANGE

- OFF timer : When the clock reaches the set time, the air conditioner will be turned off.

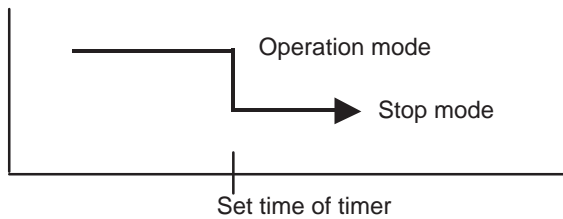

- ON timer : When the clock reaches the set time, the air conditioner will be turned on.

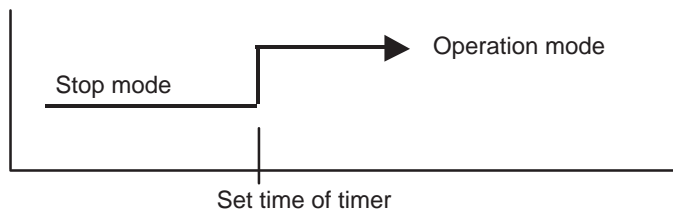

2. PROGRAM TIMER

- The program timer allows the OFF timer and ON timer to be used in combination one time.

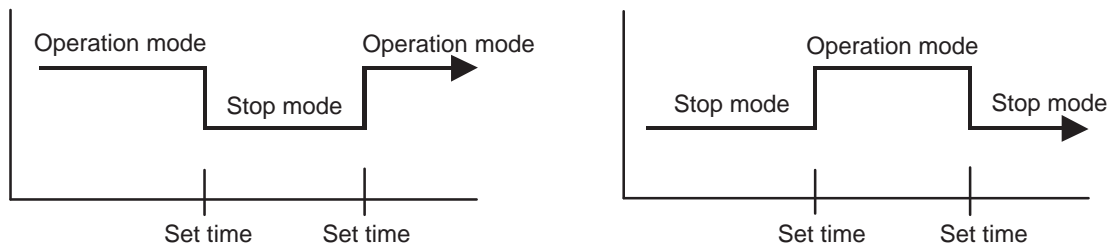

- Operation will start from the timer setting (either OFF timer or ON timer) whichever is closest to the clock's current timer setting.
The order of operations is indicated by the arrow in the remote control unit's display.
- SLEEP timer operation cannot be combined with ON timer operation.

3. SLEEP TIMER

If the sleep is set, the room temperature is monitored and the operation is stopped automatically. If the operation mode or the set temperature is change after the sleep timer is set, the operation is continued according to the changed setting of the sleep timer from that time ON.

In the cooling operation mode

When the sleep timer is set, the setting temperature is increased 1°C. It increases the setting temperature another 1°C after 1 hour. After that, the setting temperature is not changed and the operation is stopped at the time of timer setting.

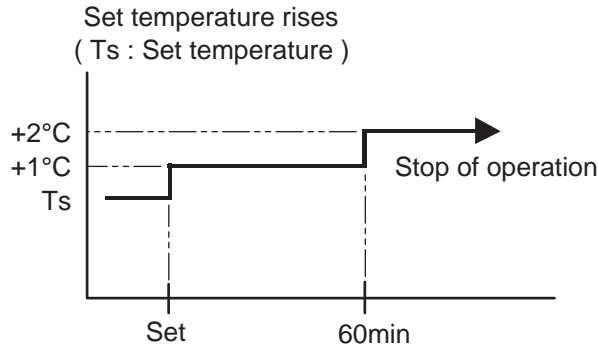

In the heating operation mode

When the sleep timer is set, the setting temperature is decreased 1°C. It decreases the setting temperature another 1°C every 30 minutes. Upon lowering 4°C, the setting temperature is not changed and the operation stops at the time of timer setting.

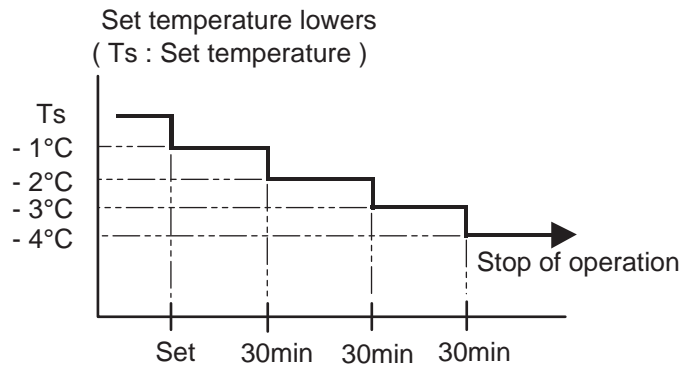

9-2 WIRED REMOTE CONTROLLER (OPTION)

The Table13 shows the available timer setting based on the product model.

(Table13 : Timer Setting)

	ON TIMER / OFF TIMER	WEEKLY TIMER	TEMPERATURE SET BACK TIMER
AS* G09/ 12LECB	○	○	○

1. ON TIMER / OFF TIMER

Same to 9-1 1.ON TIMER / OFF TIMER and shown in those.

2. WEEKLY TIMER

This timer function can set operation times of the each day of the week.

All days can be set together,the weekly timer can be used to repeat the timer setting for all of the days.

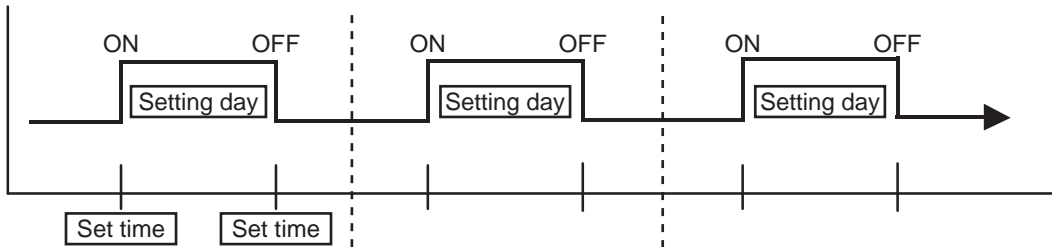

3. TEMPERATURE SET BACK TIMER

This timer function can change setting temperature of setting operation times of the each day of the week.

This can be together with other timer setting.

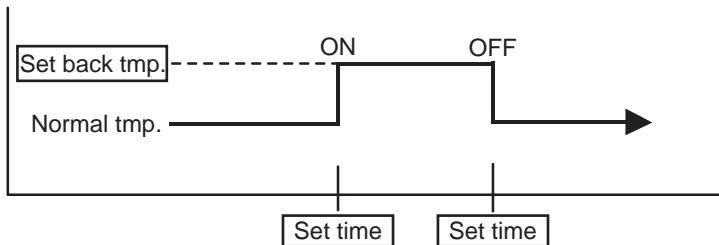

10. ELECTRONIC EXPANSION VALVE CONTROL

The most proper opening of the electronic expansion valve is calculated and controlled under the present operating condition based on the following values.

The compressor frequency, the temperatures detected by the discharge temperature sensor, the indoor heat exchanger sensor, the outdoor heat exchanger sensor, and the outdoor temperature sensor.

- * The pulse range of the electronic expansion valve control is between 60 to 480 pulses.
- * The expansion valve is set at 480 pulses after 110 seconds of stopping compressor.
- * At the time of supplying the power to the outdoor unit, the initialization of the electronic expansion valve is operated (528 pulses are input to the closing direction).

11. TEST OPERATION CONTROL

[Wireless remote controller]

Under the condition where the air conditioner runs, press the test run button of the remote control, and the test operation control mode will appear.

During test running, the operation lamp and timer lamp of the air conditioner body twinkle simultaneously.

[Wired remote controller (Option)]

If the operation lamp is on, press the Start/Stop button to turn it off.

Press the Master Control and Fan Control buttons at the same time for more than two seconds to start the test operation.

The operation lamp will light up and "o1" will be displayed on the set temperature display.

[Release]

Perform the test operation for 60 minutes.

Pressing the Start/Stop button will stop the test operation.

12. PREVENT TO RESTART FOR 3 MINUTES (3 MINUTES ST)

The compressor won't enter operation status for 2 minutes and 20 seconds after the compressor is stopped, even if any operation is given.

13. FOUR-WAY VALVE EXTENSION SELECT

At the time when the air conditioner is switched from the cooling mode to heating mode, the compressor is stopped, and the four-way valve is switched in 2 minutes and 20 seconds later after the compressor stopped.

14. AUTO RESTART

When the power was interrupted by a power failure, etc. during operation, the operation contents at that time are memorized and when power is recovered, operation is automatically started with the memorized operation contents.

When the power is interrupted and recovered during timer operation, since the timer operation time is shifted by the time the power was interrupted, an alarm is given by blinking (7 sec ON/2 sec OFF) the indoor unit body timer lamp.

[Operation contents memorized when the power is interrupted]

- Operation mode
- Set temperature
- Set air flow
- Timer mode and timer time (set by wireless remote controller)
- Set air flow Direction
- Swing
- Economy operation
- 10°C HEAT operation

15. MANUAL AUTO OPERATION (Indoor unit body operation)

If MANUAL AUTO Button is set, the operation is controlled as shown in Table14.

If the remote control is lost or battery power dissipated, this function will work without the remote control.

(Table 14)

Manual auto operation	
OPERATION MODE	Auto changeover
FAN CONT. MODE	Auto
TIMER MODE	Continuous (No timer setting available)
SETTING TEMP.	24°C
SETTING LOUVER	Standard
SWING	OFF

16. FORCED COOLING OPERATION

Forced cooling operation is started when pressing MANUAL AUTO button for 10 seconds or more. During the forced cooling operation, it operates regardless of room temperature sensor. Operation LED and timer LED blink during the forced cooling operation. They blink for 1 second ON and 1 second OFF on both operation LED and timer LED (same as test run operation).

Forced cooling operation is released after 60 minutes of starting operation.

The FORCED COOLING OPERATION will start as shown in Table15.

(Table 15)

Forced cooling operation	
OPERATION MODE	Cooling
FAN CONT. MODE	Hi
TIMER MODE	-
SETTING TEMP.	Room Temp is not controlled
SETTING LOUVER	Horizontal
SWING	OFF

17. COMPRESSOR PREHEATING

When the outdoor heat exchanger temperature is lower than 5°C and the all operation has been stopped for 30 minutes, power is applied to the compressor and the compressor is heated.

(By heating the compressor, warm air is quickly discharged when operation is started.)

When operation was started and when the outdoor temperature rises to 7°C or greater, preheating is ended.

(Fig.11 : Outdoor heat exchanger temperature)

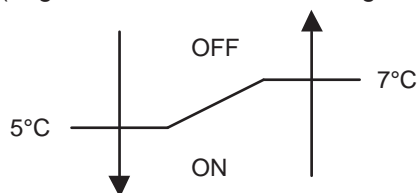

18. 10°C HEAT OPERATION

The 10°C HEAT operation functions by pressing 10°C HEAT button on the remote controller. The 10°C HEAT operation is almost the same operation as below settings.

(Table16)

Mode	Heating
Setting temperature	10°C
Fan mode	Auto

19. ECONOMY OPERATION

The ECONOMY operation functions by pressing ECONOMY button on the remote controller. The ECONOMY operation is almost the same operation as below settings.

(Table17)

Mode	Cooling/ Dry	Heating
Target temperature	Setting temp.+1°C	Setting temp.-1°C

20. BASE HEATER OPERATION

The base heater is operated as shown in Fig. 12.

(Fig.12 : Base heater control)

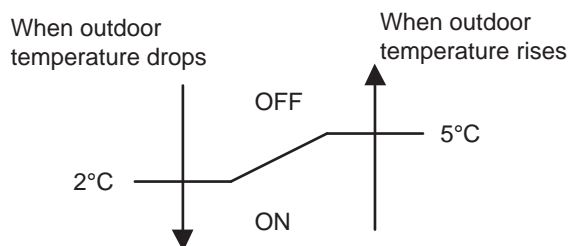

- * When the compressor stops, Base heater is OFF.
- * When the outdoor fan motor stops, Base heater is OFF.
- * In the cooling mode, Base heater is OFF.
- * In the defrost operation, Base heater maintains the same status as before the compressor stops.

21. DEFROST OPERATION CONTROL

1. CONDITION OF STARTING THE DEFROST OPERATION

The defrost operation starts when the outdoor heat exchanger temperature sensor (Tn) detects the temperature lower than the values shown in Table 18.

(Table 18 : Condition of starting Defrost Operation)

Normal defrost	Compressor integrating operation time	
	Less than 35 minutes	More than 35 minutes
Does not operate		$T_n \leq -17^\circ\text{C}$ (at outside air temp. $\geq -10^\circ\text{C}$)
		$T_n \leq \text{Outside air temp.} - 7^\circ\text{C}$ or $T_n \leq -20^\circ\text{C}$ (at $-20^\circ\text{C} \leq \text{outside air temp.} < -10^\circ\text{C}$)
		$T_n \leq \text{Outside air temp.} - 7^\circ\text{C}$ or $T_n \leq -30^\circ\text{C}$ (at outside air temp. $< -20^\circ\text{C}$)
		$T_n - T_{n10} < -5\text{deg}$ $T_n - T_{nb} < -2\text{deg}$ However, $T_n \leq -6^\circ\text{C}$

Tn10 : Temperature of continuous operation at 10 minutes.

Tnb : Back 5 minutes temperature

Integrating defrost	Compressor integrating operation time		
	More than 240 minutes (For continuous operation)	More than 213 minutes (For continuous operation)	Less than 10 minutes* (For intermittent operation)
	Outdoor heat exchanger temperature below -3°C	Outdoor heat exchanger temperature below -5°C	OFF count of the compressor 40 times

*If the compressor continuous operation time is less than 10 minutes, the OFF number of the compressor is counted.
If any defrost operated, the compressor OFF count is cleared.

2. CONDITION OF THE DEFROST OPERATION COMPLETION

Defrost operation is released when the conditions become as shown in Table 19.

(Table 19 : Defrost Release Condition)

Release Condition
Outdoor heat exchanger temperature sensor value is higher than $+16^\circ\text{C}$ or Compressor operation time has passed 15 minutes.

3. Defrost Flow Chart

The defrosting shall proceed by the integrating operation time, outdoor temperature and outdoor heat exchanger temperature as follows.

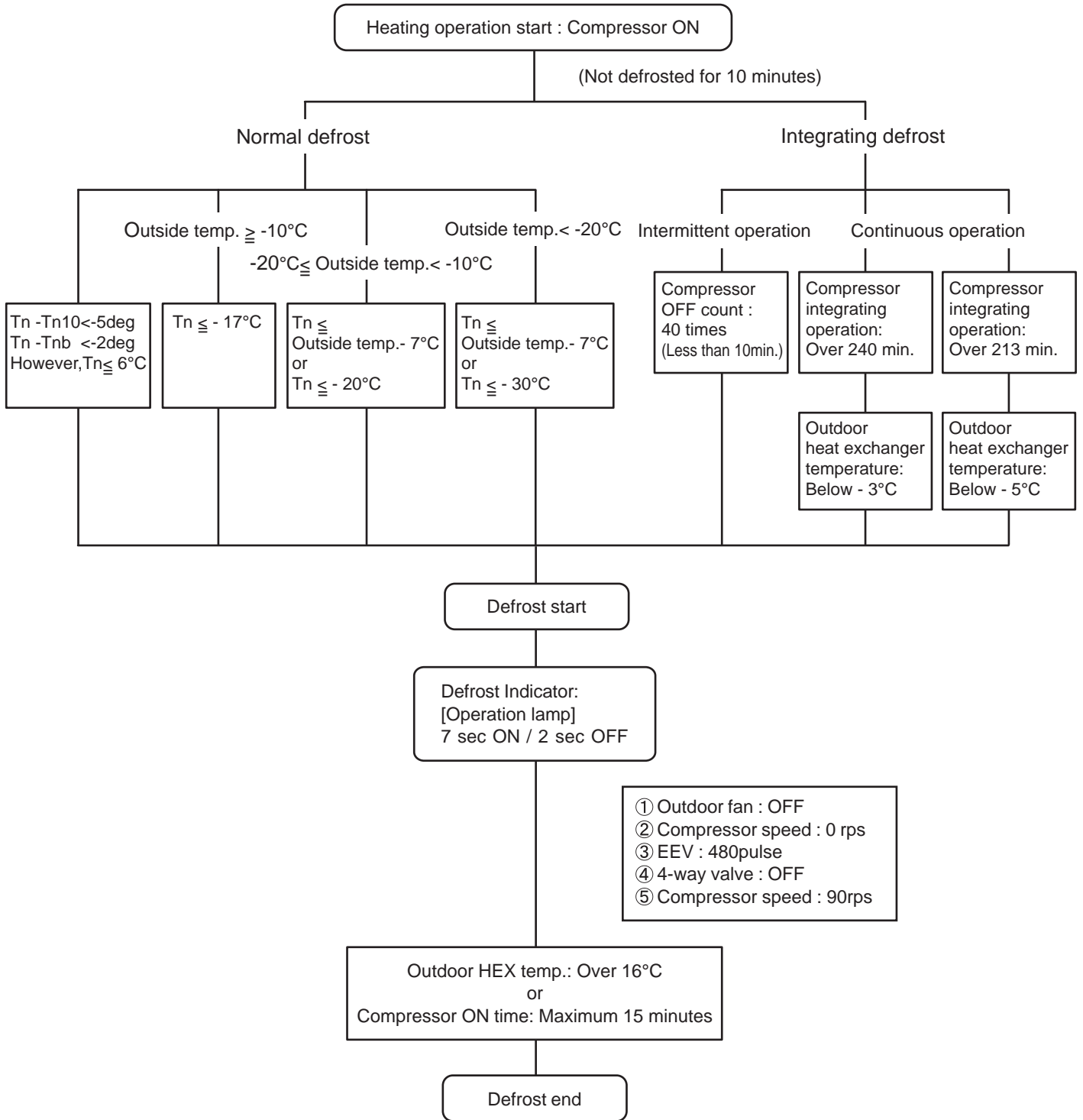

22. OFF DEFROST OPERATION CONTROL

When operation stops in the [Heating operation] mode, if frost is adhered to the outdoor unit heat exchanger, the defrost operation will proceed automatically. In this time, if indoor unit operation lamp flashes slowly (7 sec ON / 2 sec OFF), the outdoor unit will allow the heat exchanger to defrost, and then stop.

1. OFF DEFROST OPERATION CONDITION

In heating operation, the outdoor heat exchanger temperature is less than -4°C , and compressor operation integrating time lasts for more than 30 minutes.

2. OFF DEFROST END CONDITION

Release Condition
Outdoor heat exchanger temperature sensor value is higher than $+16^{\circ}\text{C}$ or Compressor operation time has passed 15 minutes.

OFF Defrost Flow Chart

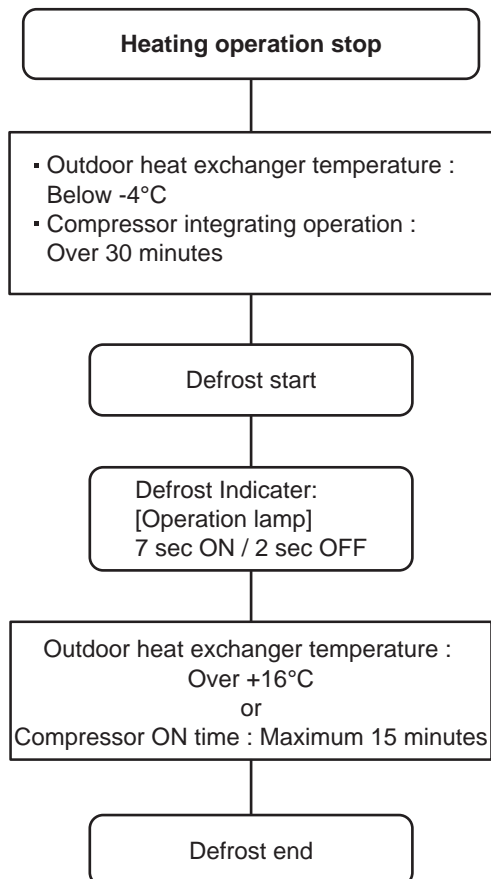

23. VARIOUS PROTECTIONS

1. DISCHARGE GAS TEMPERATURE OVERRISE PREVENION CONTROL

The discharge discharge thermistor will detect discharge gas temperature.

- 1-1. When the discharge temperature becomes higher than Temperature I, the compressor speed is decreased 20rps, and it continues to decrease the speed for 20rps every 120seconds until the temperature becomes lower than Temperature I.
When the discharge temperature becomes lower than Temperature II, the protection control of the compressor speed is released.
However, if this protection repeats and the instruction speed of the compressor falls below 18rps, the compressor will be stopped.
- 1-2. When the discharge temperature becomes higher than Temperature III, the compressor is stopped. If the above protection stop repeats 2 times, system will be stopped permanently, and the indoor unit LED starts error indication.

(Table 20 : Discharge Temperature Over Rise Prevension Control / Release Temperature)

	Temperature I	Temperature II	Temperature III
AO* G09/ 12LECAN	104°C	101°C	110°C

2. CURRENT RELEASE CONTROL

The compressor speed is controlled so that the outdoor unit input current does not exceeds the current limit value that was set up with the outdoor temperature.

The compressor speed returns to the designated speed of the indoor unit at the time when the speed becomes lower than the release value.

(Table 21 : Current Release Operation Value / Release Value)

[Heating]

AO* G09LECAN	
OT (Control / Release)	
	6.5A / 6.0A
17°C	8.0A / 7.5A
12°C	8.0A / 7.5A
5°C	8.0A / 7.5A

OT : Outdoor Temperature

AO* G12LECAN	
OT (Control / Release)	
	6.5A / 6.0A
17°C	8.0A / 7.5A
12°C	8.5A / 8.0A
5°C	9.5A / 9.0A

OT : Outdoor Temperature

[Cooling]

AO* G09LECAN	
OT (Control / Release)	
	3.5A / 3.0A
46°C	4.0A / 3.5A
42°C	5.5A / 5.0A

OT : Outdoor Temperature

AO* G12LECAN	
OT (Control / Release)	
	4.0A / 3.5A
46°C	5.0A / 4.5A
42°C	6.5A / 6.0A

OT : Outdoor Temperature

3. ANTIFREEZING CONTROL (Cooling and Dry mode)

The compressor speed is decreased on cooling & dry mode when the indoor heat exchanger temperature sensor detects the temperature lower than Temperature I. Then, the anti-freezing control is released when it becomes higher than Temperature II.

(Table 22 : Anti-freezing protection operation / Release temperature)

Outdoor temperature	Temperature I	Temperature II
Over than 10°C *2 or 12°C *1	4°C	7°C
Less than 10°C *2 or 12°C *1		13°C

*1. When the temperature rises.

*2. When the temperature drops.

4. COOLING PRESSURE OVERRISE PROTECTION

When the outdoor unit heat exchange sensor temperature rises to 67°C or greater, the compressor and the outdoor fan motor are stopped and trouble display is performed.

5. HIGH TEMPERATURE RELEASE CONTROL (HEATING MODE)

On heating mode, the compressor frequency is controlled as following based on the detection value of the indoor heat exchanger temperature sensor.

[Control System]

Indoor heat exchange temperature rises

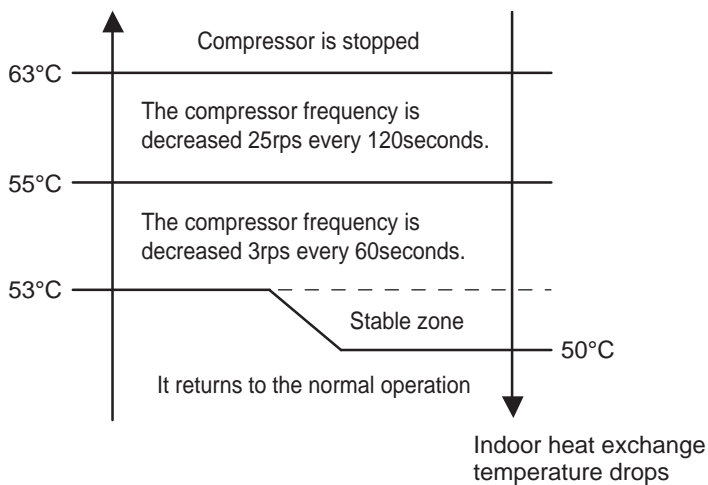

WALL MOUNTED type INVERTER

2 . TROUBLE SHOOTING

2. TROUBLESHOOTING

2-1 ERROR DISPLAY

2-1-1 INDOOR UNIT AND WIRED REMOTE CONTROLLER DISPLAY

Please refer the flashing pattern as follows.

Indoor Unit : AS*G 09/ 12LECB

The OPERATION, TIMER and ECONOMY lamps operate as follows according to the error contents.

Error Contents	Indoor Unit Display			Wired Remote Controller Display	Trouble shooting
	OPERATION (Green)	TIMER (Orange)	ECONOMY (Green)		
Serial communication error	1 times	1 times	Continuous	11	1
Wired remote controller communication error	1 times	2 times	Continuous	12	2
Indoor unit model information error EEPROM access abnormal	3 times	2 times	Continuous	32	3
Manual auto switch error	3 times	5 times	Continuous	35	4
Indoor room thermistor error	4 times	1 times	Continuous	41	5
Indoor heat Ex. thermistor error	4 times	2 times	Continuous	42	6
Indoor unit fan motor error	5 times	1 times	Continuous	51	7
Outdoor unit main PCB error	6 times	2 times	Continuous	62	9
PFC circuit error	6 times	4 times	Continuous	64	10
IPM error	6 times	5 times	Continuous	65	11
Discharge thermistor error	7 times	1 times	Continuous	71	12
Heat Ex. liquid outlet thermistor error	7 times	3 times	Continuous	73	13
Outdoor thermistor error	7 times	4 times	Continuous	74	14
Current sensor error	8 times	4 times	Continuous	84	15
Over current error	9 times	4 times	Continuous	94	16
Compressor control error	9 times	5 times	Continuous	95	17
Outdoor unit fan motor error	9 times	7 times	Continuous	97	18
4 Way valve error	9 times	9 times	Continuous	99	19
Discharge temp. error	10 times	1 times	Continuous	A1	20

2-1-2 WIRED REMOTE CONTROLLER DISPLAY (OPTION)

1. SELF - DIAGNOSIS

When "Er" in Temperature Display is displayed, inspection of the air conditioning system is necessary. Please consult authorized service personnel.

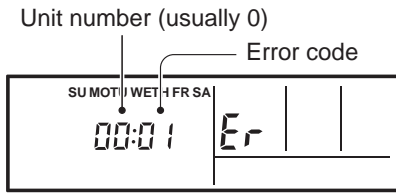

ex. Self-diagnosis check

2. ERROR CODE HISTORY DISPLAY

Up to 16 memorized error codes may be displayed for the indoor unit connected to the remote controller.

1. Stop the air conditioner operation.

2. Press the SET TEMPERATURE buttons ∇ , \blacktriangle simultaneously for 3 seconds or more to start the self-diagnosis.

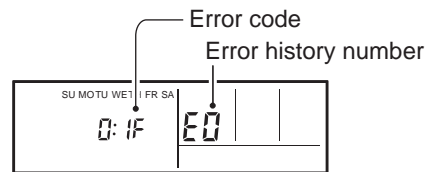
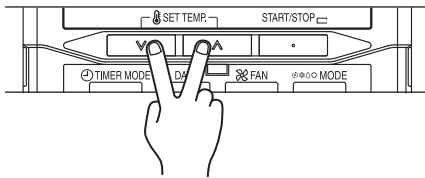

3. Press the SET TEMPERATURE button to select the error history number.

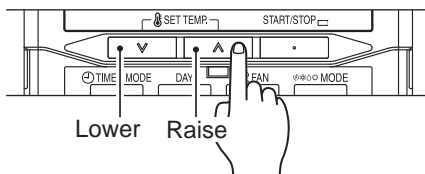

↔ 0 ↔ 1 ↔ 2 ↔ 3 ↔ 4 ↔ 5 ↔ 6 ↔ 7 ↔
↔ F ↔ E ↔ d ↔ c ↔ b ↔ A ↔ 9 ↔ 8 ↔

4. Press the SET TEMPERATURE buttons ∇ , \blacktriangle simultaneously for 3 seconds or more or there is no key input for 60 seconds to stop the display.

2-2 TROUBLE SHOOTING WITH ERROR CODE

Trouble shooting 1-1
OUTDOOR UNIT Error Method:
Serial communication error
(Serial Reverse Transfer Error)

Indicate or Display:

Refer to error code table.

Detective Actuators:

Outdoor unit Main PCB
 Outdoor unit fan motor

Detective details:

When the indoor unit cannot receive the serial signal from Outdoor unit more than 2minutes after power ON, or the indoor unit cannot receive the serial signal more than 15seconds during normal operation.

Forecast of Cause:

1. Connection failure 2. External cause 3. Main PCB failure 4. Outdoor unit fan motor failure

Check Point 1-1 : Reset the power and operate

· Does Error indication show again?

NO

YES

Check Point 2 : Check Connection

· Check any loose or removed connection line of Indoor unit and Outdoor unit.
 >> **If there is an abnormal condition, correct it by referring to Installation Manual or Data & Technical Manual.**

Check Point 1-2: Check external cause such as noise

· Check the complete insulation of the grounding.
 · Check if there is any equipment that causes harmonic wave near the power cable (Neon light bulb or any electronic equipment which causes harmonic wave).

OK

Check Point 3 : Check the voltage of power supply

· Check the voltage of power supply
 >> **Check if AC207V (AC230V -10%) - 253V (AC230V +10%) appears at Outdoor Unit Terminal L - N.**



OK

Check Point 4 : Check Serial Signal (Reverse Transfer Signal)

· Check Serial Signal (Reverse Transfer Signal)
 >> **Check if Indicated value swings between AC70V and AC130V at Outdoor Unit Terminal 1 - 3.**
 >> **If it is abnormal, Check Outdoor unit fan motor. (PARTS INFORMATION 5)**
 >> **If Outdoor fan motor is abnormal, replace Outdoor unit fan motor and Main PCB.**
 >> **If Outdoor fan motor is normal, replace Main PCB.**

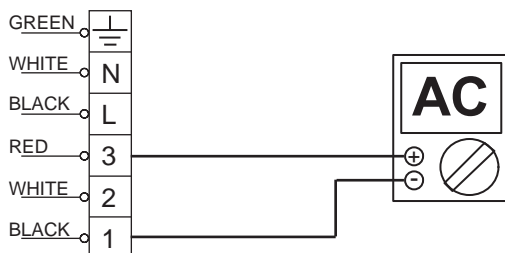

Trouble shooting 1-2 INDOOR UNIT Error Method: Serial communication error (Serial Forward Transfer Error)	Indicate or Display: Refer to error code table.
--	--

Detective Actuators: Indoor unit Controller PCB Indoor unit Fan motor Outdoor unit Main PCB	Detective details: When the outdoor unit cannot receive the serial signal from Indoor unit more than 10seconds.
---	---

Forecast of Cause: 1. Connection failure 2. External cause 3. Controller PCB failure 4. Indoor unit fan motor failure 5. Outdoor unit Main PCB
--

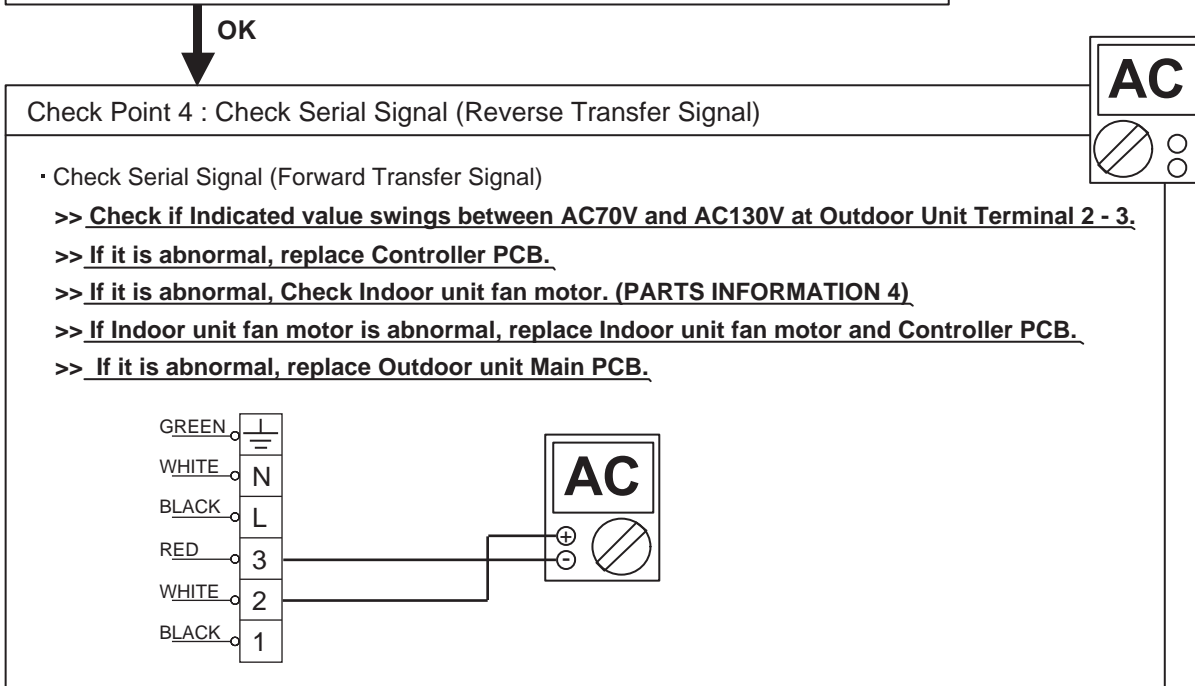
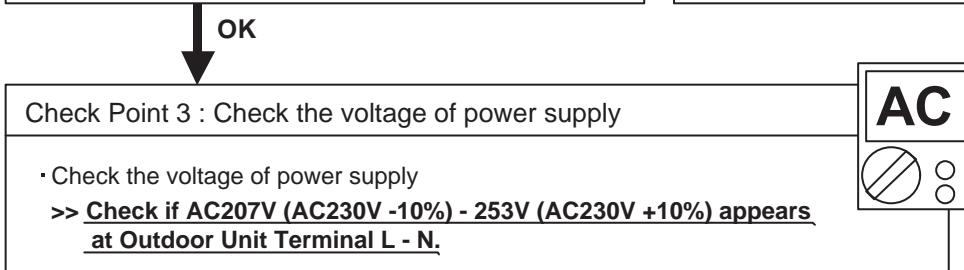
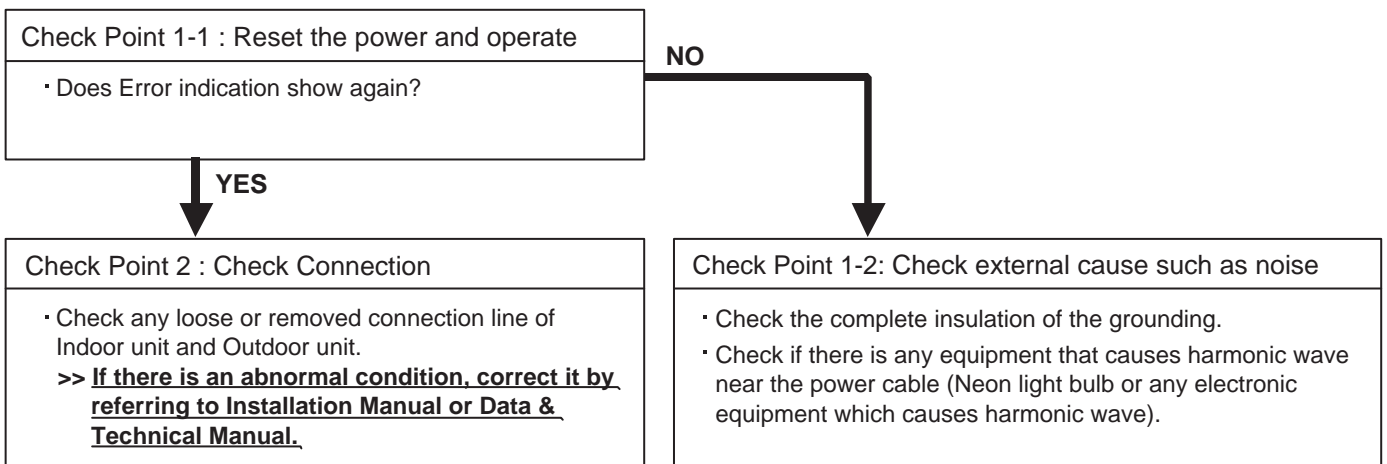

Trouble shooting 2 <u>INDOOR UNIT Error Method:</u> Remote controller communication error	<u>Indicate or Display:</u> Refer to error code table.
--	---

<u>Detective Actuators:</u> Indoor unit Controller PCB Wired remote control	<u>Detective details:</u> When the indoor unit cannot receive the signal from Wired Remote Control more than 1minute during normal operation.
--	---

<u>Forecast of Cause:</u> 1. Terminal connection abnormal 2. Wired remote control failure 3. Controller PCB failure

Check Point 1 : Check the connection of terminal
<u>After turning off the power, check & correct the followings.</u> · Check the connection of terminal between remote control and Indoor unit, and check if there is a disconnection of the cable.



Check Point 2 : Check Remote Control and Controller PCB	
· Check Voltage at CN305 (terminal 1-3) of UTY-XCBXE(Communication kit). (Power supply to Remote Control) >> If it is DC13V, Remote Control is failure. (Controller PCB is normal) >> Replace Remote Control >> If it is DC 0V, Controller PCB is failure. (Check Remote Control once again) >> Replace Controller PCB ▶ <u>Upon correcting the removed connector or mis-wiring, reset the power.</u>	

Trouble shooting 3 <u>INDOOR UNIT Error Method:</u> Indoor unit main PCB error	<u>Indicate or Display:</u> Refer to error code table.
---	---

<u>Detective Actuators:</u> Indoor unit Controller PCB	<u>Detective details:</u> When power is on and there is some below case. 1. When model information of EEPROM is incorrect. 2. When the access to EEPROM failed.
--	---

<u>Forecast of Cause:</u> 1. External cause 2. Defective connection of electric components 3. Controller PCB failure
--

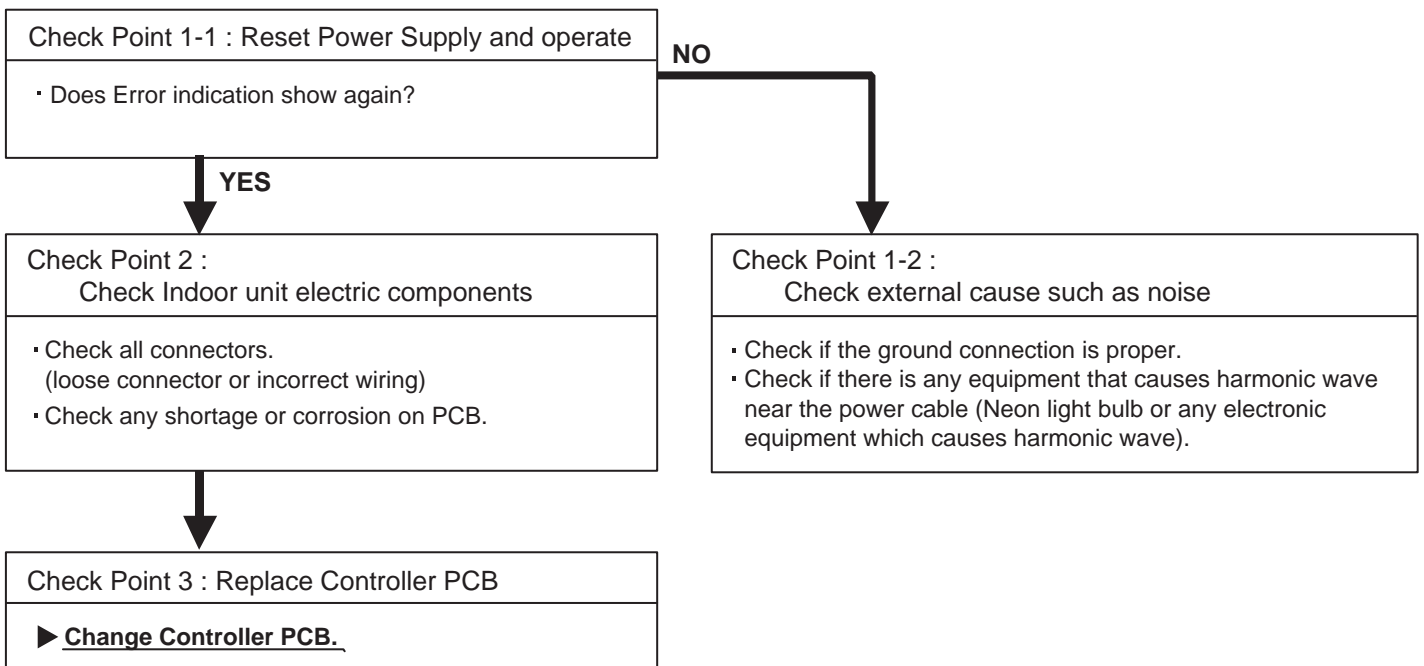

Note : EEPROM

EEPROM(Electronically Erasable and Programmable Read Only Memory) is a non-volatile memory which keeps memorized information even if power is turned off. It can change the contents electronically. To change the contents, it uses higher voltage than normal, and it can not change a partial contents. (Rewriting shall be done upon erasing the all contents.) There is a limit in a number of rewriting.

<p>Trouble shooting 4 <u>INDOOR UNIT Error Method:</u> Manual auto switch error</p>	<p><u>Indicate or Display:</u> Refer to error code table.</p>
--	--

<p><u>Detective Actuators:</u> Indoor unit Controller PCB Indicator PCB Manual auto switch</p>	<p><u>Detective details:</u> When the Manual Auto Switch becomes ON for consecutive 60 or more seconds.</p>
--	---

<p><u>Forecast of Cause :</u> 1. Manual auto switch failure 2.Controller PCB and Indicator PCB failure</p>

<p>Check Point 1 : Check the Manual auto switch</p> <ul style="list-style-type: none"> • Check if Manual auto switch is kept pressed. • Check ON/OFF switching operation by using a meter. <p>>><u>If Manual Auto Switch is disabled (on/off switching), replace it.</u></p>	
---	--



<p>Check Point 2 : Replace Controller PCB</p>
<p>▶ <u>If Check Point 1 do not improve the symptom, change Controller PCB and Indicator PCB.</u></p>

Trouble shooting 5 INDOOR UNIT Error Method: Room temperature sensor error	Indicate or Display: Refer to error code table.
---	--

Detective Actuators: Indoor unit Controller PCB Room temperature thermistor	Detective details: When Room Temperature Thermistor open or short-circuit is detected.
--	--

Forecast of Cause : 1. Connector connection failure 2. Thermistor failure 3. Controller PCB failure

Check Point 1 : Check connection of Connector
<ul style="list-style-type: none"> • Check if connector is removed. • Check erroneous connection. • Check if thermistor cable is open. >>Upon correcting the removed connector or mis-wiring, reset the power.



Check Point 2 : Remove connector and check Thermistor resistance value									
Thermistor Characteristics (Approx. value)									
Temperature	-10°C	-5°C	0°C	5°C	10°C	15°C	20°C	25°C	
Resistance Value (kΩ)	58.2	44.0	33.6	25.9	20.2	15.8	12.5	10.0	
Temperature	30°C	35°C	40°C	45°C					
Resistance Value (kΩ)	8.0	6.5	5.3	4.3					
► If Thermistor is either open or shorted, replace it and reset the power.									



Check Point 3 : Check voltage of Controller PCB (DC5.0V)		
Make sure circuit diagram of indoor unit and check terminal voltage at Thermistor (DC5.0V)		
<div style="border: 1px solid black; padding: 5px;"> <p>THERMISTOR (PIPE)</p> </div>		
► If the voltage does not appear, replace Controller PCB.		

Trouble shooting 6 INDOOR UNIT Error Method: Indoor unit Heat Ex. sensor error	Indicate or Display: Refer to error code table.
---	--

Detective Actuators: Indoor unit Controller PCB Heat Ex. temperature thermistor	Detective details: When Heat Ex. Temperature Thermistor open or short-circuit is detected.
--	--

Forecast of Cause : 1. Connector connection failure 2. Thermistor failure 3. Controller PCB failure

Check Point 1 : Check connection of Connector
<ul style="list-style-type: none"> • Check if connector is removed. • Check erroneous connection. • Check if thermistor cable is open. <p>>>Upon correcting the removed connector or mis-wiring, reset the power.</p>



Check Point 2 : Remove connector and check Thermistor resistance value									
Thermistor Characteristics (Approx. value)									
Temperature	-30°C	-20°C	-10°C	-5°C	0°C	5°C	10°C	20°C	
Resistance Value (kΩ)	1131.9	579.6	312.3	233.2	176.0	134.2	103.3	62.9	
Temperature	30°C	40°C	50°C	60°C	63°C				
Resistance Value (kΩ)	39.6	25.6	17.1	11.6	10.4				
<p>► If Thermistor is either open or shorted, replace it and reset the power.</p>									



Check Point 3 : Check voltage of Controller PCB (DC5.0V)		
Make sure circuit diagram of indoor unit and check terminal voltage at Thermistor (DC5.0V)		
<p>► If the voltage does not appear, replace Controller PCB.</p>		

<p>Trouble shooting 7 <u>INDOOR UNIT Error Method:</u> Indoor unit fan motor error</p>	<p><u>Indicate or Display:</u> Refer to error code table.</p>
---	--

<p><u>Detective Actuators:</u> Indoor unit Controller PCB Indoor unit Fan motor</p>	<p><u>Detective details:</u> When the condition that actual frequency of Indoor Fan is below 1/3 of target frequency is continued more than 56 seconds.</p>
--	---

<p><u>Forecast of Cause:</u> 1. Fan rotation failure 2. Fan motor winding open 3. Motor protection by surrounding temperature rise 4. Control PCB failure 5. Indoor unit fan motor failure</p>
--

<p>Check Point 1 : Check rotation of Fan</p>
<p>• Rotate the fan by hand when operation is off. (Check if fan is caught, dropped off or locked motor) >><u>If Fan or Bearing is abnormal, replace it.</u></p>



<p>Check Point 2 : Check ambient temp. around motor</p>
<p>• Check excessively high temperature around the motor. (If there is any surrounding equipment that causes heat) >><u>Upon the temperature coming down, restart operation.</u></p>



<p>Check Point 3 : Check Indoor unit fan motor</p>
<p>• Check Indoor unit fan motor. (PARTS INFORMATION 4) >><u>If Indoor unit fan motor is abnormal, replace Indoor unit fan motor.</u></p>



<p>Check Point 4 : Replace Controller PCB</p>
<p>► <u>If Check Point 1- 3 do not improve the symptom, replace Controller PCB.</u></p>

Trouble shooting 9 <u>OUTDOOR UNIT Error Method:</u> Outdoor unit main PCB error	<u>Indicate or Display:</u> Refer to error code table.
--	--

<u>Detective Actuators:</u> Outdoor unit Main PCB	<u>Detective details:</u> Access to EEPROM failed due to some cause after outdoor unit started.
--	--

<u>Forecast of Cause:</u> 1. External cause (Noise, temporary open, voltage drop) 2. Main PCB failure

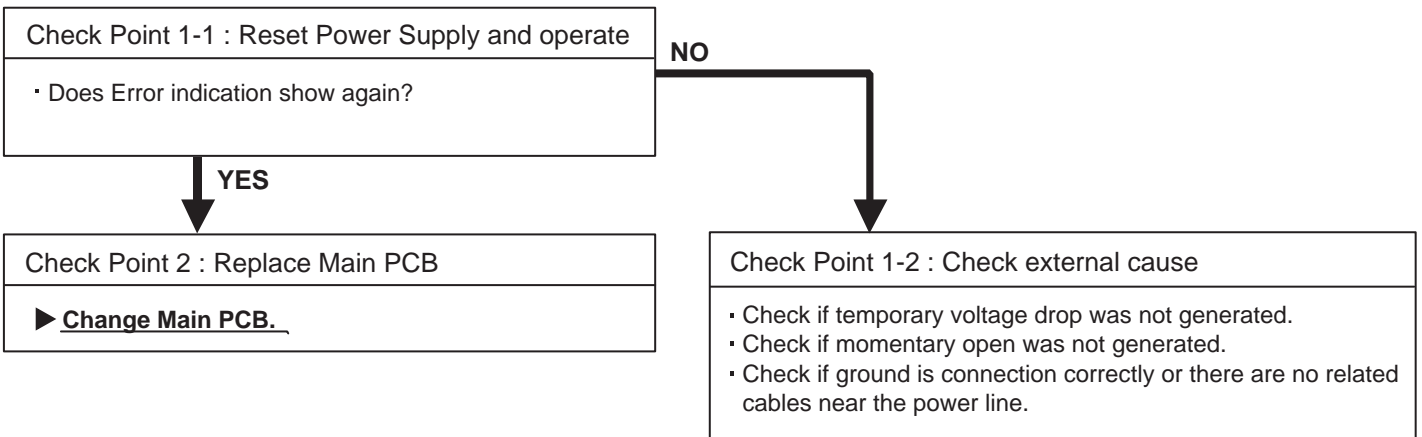

Trouble shooting 10 <u>OUTDOOR UNIT Error Method:</u> PFC circuit error	<u>Indicate or Display:</u> Refer to error code table.
--	---

<u>Detective Actuators:</u> Outdoor unit Main PCB	<u>Detective details:</u> When inverter output DC voltage is higher than 415V for over 3 seconds, the compressor stops. If the same operation is repeated 5 times, the compressor stops permanently.
---	---

<u>Forecast of Cause :</u> 1. External cause 2. Connector connection failure 3. Main PCB failure
--

Check Point 1 : Check external cause at Indoor and Outdoor (Voltage drop or Noise)
<ul style="list-style-type: none"> • Instant drop : Check if there is a large load electric apparatus in the same circuit. • Momentary power failure : Check if there is a defective contact or leak current in the power supply circuit. • Noise : Check if there is any equipment causing harmonic wave near electric line. (Neon bulb or electric equipment that may cause harmonic wave) Check the complete insulation of grounding.



Check Point 2 : Check connection of Connector
<ul style="list-style-type: none"> • Check if connector is removed. • Check erroneous connection. • Check if cable is open. <p>>><u>Upon correcting the removed connector or mis-wiring, reset the power.</u></p>



Check Point 3 : Replace Main PCB
<p>▶ <u>If Check Point 1, 2 do not improve the symptom, change Main PCB.</u></p>

Trouble shooting 11 OUTDOOR UNIT Error Method: IPM error	<u>Indicate or Display:</u> Refer to error code table.
---	---

<u>Detective Actuators:</u> Outdoor unit Main PCB Compressor	<u>Detective details:</u> ① When more than normal operating current to IPM in Main PCB flows, the compressor stops. ② After the compressor restarts, if the same operation is repeated within 40sec, the compressor stops again. ③ If ① and ② repeats 5 times, the compressor stops permanently.
---	--

<u>Forecast of Cause :</u> 1. Defective connection of electric components 2. Outdoor Fan Operation failure 3. Outdoor Heat Exchanger clogged 4. Compressor failure 5. Main PCB failure		
--	--	--

Check Point 1 : Check connections of Outdoor Unit Electrical Components
<ul style="list-style-type: none"> • Check if the terminal connection is loose. • Check if connector is removed. • Check erroneous connection. • Check if cable is open. <p>>> <u>Upon correcting the removed connector or mis-wiring, reset the power.</u></p>



Check Point 2 : Check Outdoor Fan, Heat Exchanger
<ul style="list-style-type: none"> • Is there anything obstructing the air distribution circuit? • Is there any clogging of Outdoor Heat Exchanger? • Is the Fan rotating by hand when operation is off ? <p>>> <u>If the Fan Motor is locked, replace it.</u></p>



Check Point 3 : Check Outdoor Fan
<ul style="list-style-type: none"> • Check Outdoor Fan Motor. (Refer to Trouble shooting 17) <p>>> <u>If the Fan Motor is failure, replace it.</u></p>



Check Point 4 : Check Compressor
<ul style="list-style-type: none"> • Check Compressor. (PARTS INFORMATION 2)



Check Point 5 : Replace Main PCB
<p>▶ <u>If Check Point 1~ 4 do not improve the symptom, change Main PCB.</u></p>

Trouble shooting 12 OUTDOOR UNIT Error Method: Discharge thermistor error	Indicate or Display: Refer to error code table.
--	--

Detective Actuators: Outdoor unit Main PCB Discharge pipe temperature thermistor	Detective details: When Discharge pipe temperature thermistor open or short-circuit is detected at power ON or while running the compressor.
---	--

Forecast of Cause :
1. Connector connection failure 2. Thermistor failure 3. Main PCB failure

Check Point 1 : Check connection of Connector

- Check if connector is removed.
- Check erroneous connection.
- Check if thermistor cable is open.

>>Upon correcting the removed connector or mis-wiring, reset the power.



Check Point 2 : Remove connector and check Thermistor resistance value

Ω

Thermistor Characteristics (Approx. value)

Temperature	-30°C	-20°C	-10°C	-5°C	0°C	5°C	10°C	20°C	30°C
Resistance Value (k Ω)	1013.1	531.6	292.9	221.1	168.6	129.8	100.9	62.5	40.0

Temperature	40°C	50°C	60°C	70°C	80°C	90°C	100°C	110°C	120°C
Resistance Value (k Ω)	26.3	17.8	12.3	8.7	6.3	4.6	3.4	2.6	2.0

► If Thermistor is either open or shorted, replace it and reset the power.



Check Point 3 : Check voltage of Main PCB (DC5.0V)

DC

Make sure circuit diagram of outdoor unit and check terminal voltage at Thermistor (DC5.0V)

THERMISTOR (PIPE) BLACK 1 1
BLACK 2 2
BLACK 3 3
BLACK 4 4 CN71

THERMISTOR (DISCHARGE)

THERMISTOR (OUTDOOR) BLACK 1 1
BLACK 2 2
BLACK 3 3 CN70

► If the voltage does not appear, replace Main PCB.

Trouble shooting 13 OUTDOOR UNIT Error Method: Outdoor unit Heat Ex. sensor error	Indicate or Display: Refer to error code table.
--	--

Detective Actuators: Outdoor unit Main PCB Heat exchanger temperature thermistor	Detective details: When Heat exchanger temperature thermistor open or short-circuit is detected at power ON or while running the compressor.
---	--

Forecast of Cause :
1. Connector connection failure 2. Thermistor failure 3. Main PCB failure

Check Point 1 : Check connection of Connector

- Check if connector is removed.
- Check erroneous connection.
- Check if thermistor cable is open.

>>Upon correcting the removed connector or mis-wiring, reset the power.



Check Point 2 : Remove connector and check Thermistor resistance value Ω

Thermistor Characteristics (Approx. value)

Temperature	-30°C	-20°C	-10°C	-5°C	0°C	5°C	10°C	20°C	30°C
Resistance Value (kΩ)	95.6	50.3	27.8	21.0	16.1	12.4	9.6	6.0	3.8

Temperature	40°C	50°C	60°C	70°C	80°C
Resistance Value (kΩ)	2.5	1.7	1.2	0.8	0.6

▶ **If Thermistor is either open or shorted, replace it and reset the power.**



Check Point 3 : Check voltage of Main PCB (DC5.0V) DC

Make sure circuit diagram of outdoor unit and check terminal voltage at Thermistor (DC5.0V)

The diagram shows two thermistor components. The first is labeled 'THERMISTOR (PIPE)' and is connected to a 4-pin connector labeled 'CN71'. All four pins (1, 2, 3, 4) are connected to 'BLACK' wires. The second is labeled 'THERMISTOR (OUTDOOR)' and is connected to a 3-pin connector labeled 'CN70'. All three pins (1, 2, 3) are connected to 'BLACK' wires.

▶ **If the voltage does not appear, replace Main PCB.**

Trouble shooting 14 <u>OUTDOOR UNIT Error Method:</u> Outdoor thermistor error	<u>Indicate or Display:</u> Refer to error code table.
---	---

<u>Detective Actuators:</u> Outdoor unit Main PCB Outdoor temperature thermistor	<u>Detective details:</u> When Outdoor temperature thermistor open or short-circuit is detected at power ON or while running the compressor.
---	--

Forecast of Cause :
1. Connector connection failure 2. Thermistor failure 3. Main PCB failure

Check Point 1 : Check connection of Connector

- Check if connector is removed.
- Check erroneous connection.
- Check if thermistor cable is open.

>>Upon correcting the removed connector or mis-wiring, reset the power.



Check Point 2 : Remove connector and check Thermistor resistance value Ω

Thermistor Characteristics (Approx. value)

Temperature	-30°C	-25°C	-20°C	-15°C	-10°C	-5°C	0°C	5°C	10°C
Resistance Value (k Ω)	224.3	159.7	115.2	84.2	62.3	46.6	35.2	26.9	20.7

Temperature	15°C	20°C	25°C	30°C	35°C	40°C	45°C	50°C	55°C
Resistance Value (k Ω)	16.1	12.6	10.0	8.0	6.4	5.2	4.2	3.5	2.8

► If Thermistor is either open or shorted, replace it and reset the power.



Check Point 3 : Check voltage of Main PCB (DC5.0V) DC

Make sure circuit diagram of outdoor unit and check terminal voltage at Thermistor (DC5.0V)

THERMISTOR (PIPE) BLACK 1 1
BLACK 2 2
BLACK 3 3
BLACK 4 4 CN71
THERMISTOR (DISCHARGE)
THERMISTOR (OUTDOOR) BLACK 1 1
BLACK 2 2
BLACK 3 3 CN70

► If the voltage does not appear, replace Main PCB.

Trouble shooting 15 OUTDOOR UNIT Error Method: Current sensor error	<u>Indicate or Display:</u> Refer to error code table.
--	--

<u>Detective Actuators:</u> Outdoor unit Main PCB	<u>Detective details:</u> When Input Current Sensor has detected 0A, while Inverter Compressor is operating at higher than 56rps, after 1minute upon starting the Compressor. (Except during the defrost operation)
--	--

<u>Forecast of Cause :</u> 1. Defective connection of electric components 2. External cause 3. Main PCB failure
--

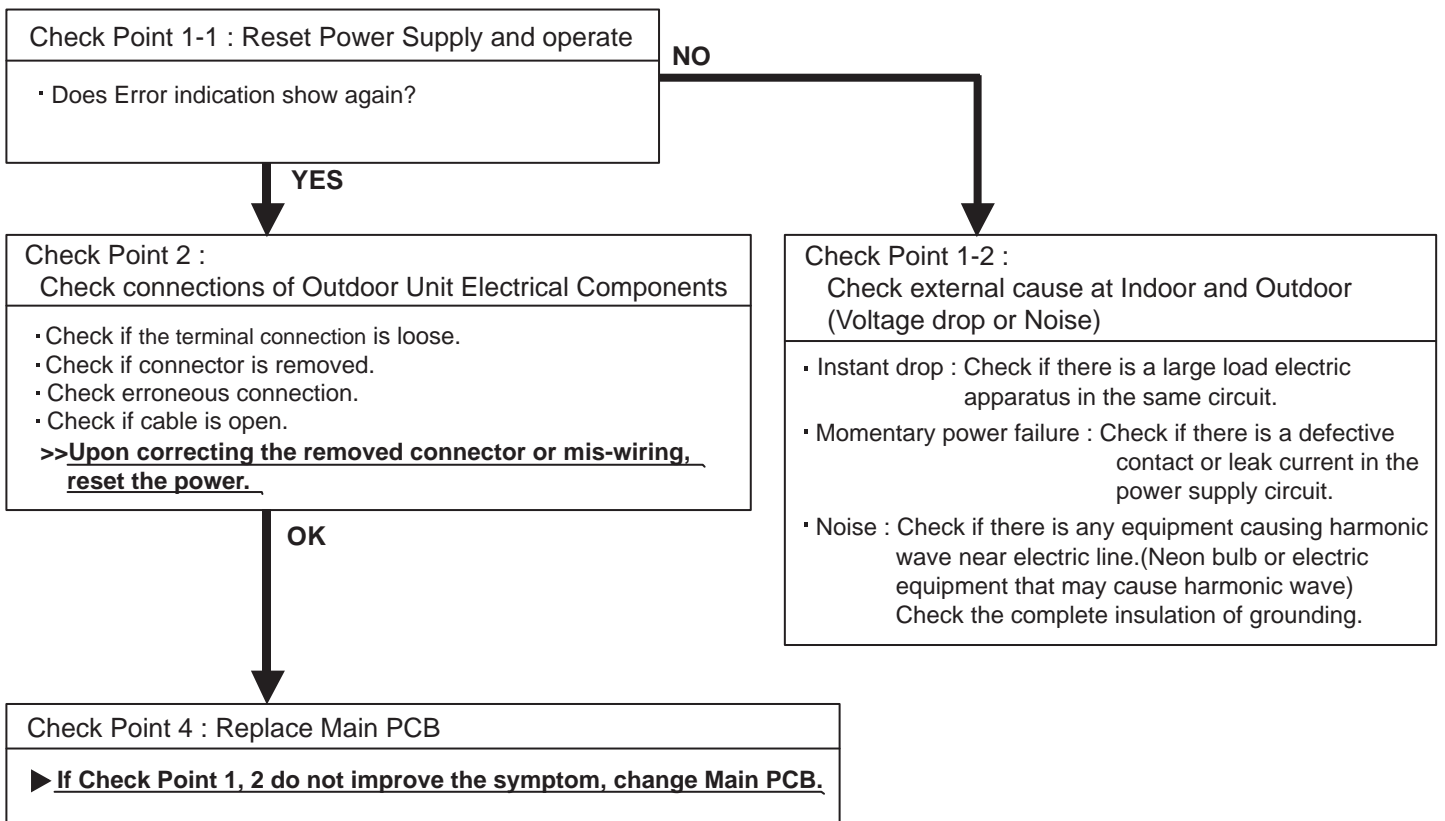

Trouble shooting 16 <u>OUTDOOR UNIT Error Method:</u> Trip detection	<u>Indicate or Display:</u> Refer to error code table.
---	---

<u>Detective Actuators:</u> Outdoor unit Main PCB Compressor	<u>Detective details:</u> ▪ "Protection stop by overcurrent generation after inverter compressor start processing completed" generated consecutively 10 times. * The number of generations is reset if the start-up of the compressor succeeds.
---	---

<u>Forecast of Cause :</u> <ol style="list-style-type: none"> 1. Outdoor unit fan operation defective, foreign matter on hear exchanger, excessive rise of ambient temperature 2. Inverter PCB failure 3. Inverter compressor failure (lock, winding short)

Check Point 1 : Check the outdoor unit fan operation, heat exchanger, ambient temperature <ul style="list-style-type: none"> ▪ No obstructions in air passages? ▪ Heat exchange fins clogged ▪ Outdoor unit fan motor check ▪ Ambient temperature not raised by the effect of other heat sources? ▪ Discharged air not sucked in?



Check Point 2: Replace Main PCB <ul style="list-style-type: none"> ▶ <u>If Check Point 1 do not improve the symptom, change Main PCB.</u>
--



Check Point 3: Replace Compressor <ul style="list-style-type: none"> ▶ <u>If Check Point 2 do not improve the symptom, change Compressor.</u>
--

Trouble shooting 17 OUTDOOR UNIT Error Method: Compressor motor control error	Indicate or Display: Refer to error code table.
--	--

Detective Actuators: Outdoor unit Main PCB Compressor	Detective details: ① If the detected rotor location is out of phase with actual rotor location more than 90°, the compressor stops. After the compressor restarts, if the same operation is repeated ② within 40sec, the compressor stops again. ③ If ① and ② repeats 5 times, the compressor stops permanently.
--	---

Forecast of Cause : 1. Defective connection of electric components 2. Main PCB failure 3. Compressor failure
--

Check Point 1 : Check Noise from Compressor • Turn on Power and check operation noise. ▶ <u>If an abnormal noise show, replace Compressor.</u>
--



Check Point 2 : Check connection of around the Compressor components For Compressor Terminal, Main PCB • Check if connector is removed. • Check erroneous connection. • Check if cable is open. (Refer to PARTS INFORMATION 2) >> <u>Upon correcting the removed connector or mis-wiring, reset the power.</u>
--



Check Point 3: Replace Main PCB ▶ <u>If Check Point 1,2 do not improve the symptom, change Main PCB.</u>



Check Point 4: Replace Compressor ▶ <u>If Check Point 3 do not improve the symptom, change Compressor.</u>

Trouble shooting 18 OUTDOOR UNIT Error Method: Outdoor unit fan motor error	Indicate or Display: Refer to error code table.
--	--

Detective Actuators: Outdoor unit Main PCB Outdoor unit Fan motor	Detective details: ① When outdoor fan rotation speed is less than 100rpm in 20 seconds after fan motor starts, fan motor stops. ② After fan motor restarts, if the same operation within 60sec is repeated 3 times in a row, compressor and fan motor stops. ③ If ① and ② repeats 5 times in a row, compressor and fan motor stops permanently.
--	---

Forecast of Cause: 1. Fan rotation failure 2. Motor protection by surrounding temperature rise 3. Main PCB failure 4. Outdoor unit fan motor

Check Point 1 : Check rotation of Fan
<ul style="list-style-type: none"> Rotate the fan by hand when operation is off. (Check if fan is caught, dropped off or locked motor) <p>>>If Fan or Bearing is abnormal, replace it.</p>

↓
OK

Check Point 2 : Check ambient temp. around motor
<ul style="list-style-type: none"> Check excessively high temperature around the motor. (If there is any surrounding equipment that causes heat) <p>>>Upon the temperature coming down, restart operation.</p>

↓
OK

Check Point 3 : Check Outdoor unit fan motor
<ul style="list-style-type: none"> Check Outdoor unit fan motor. (PARTS INFORMATION 5) <p>>>If Outdoor unit fan motor is abnormal, replace Outdoor unit fan motor.</p>

↓
OK

Check Point 4 : Check Output Voltage of Main PCB							
<ul style="list-style-type: none"> Check outdoor unit circuit diagram and the voltage. (Measure at Main PCB side connector) 							
<table border="1"> <thead> <tr> <th>Read wire</th> <th>DC voltage</th> </tr> </thead> <tbody> <tr> <td>Red - Black</td> <td>293V (AC230V-10%) ~ 358V (AC230+10%)</td> </tr> <tr> <td>White - Black</td> <td>15 ± 1.5V</td> </tr> </tbody> </table>	Read wire	DC voltage	Red - Black	293V (AC230V-10%) ~ 358V (AC230+10%)	White - Black	15 ± 1.5V	
Read wire	DC voltage						
Red - Black	293V (AC230V-10%) ~ 358V (AC230+10%)						
White - Black	15 ± 1.5V						
▶ If the voltage is not correct, replace Main PCB.							

Trouble shooting 19 <u>INDOOR UNIT Error Method:</u> 4-way valve error	<u>Indicate or Display:</u> Refer to error code table.
--	--

<u>Detective Actuators:</u> Indoor unit Controller PCB Heat Ex. temperature thermistor Room temperature thermistor 4-way valve	<u>Detective details:</u> When the indoor heat exchanger temperature is compared with the room temperature, and either following condition is detected continuously two times, the compressor stops. <ul style="list-style-type: none"> ▪ Cooling or Dry operation [Indoor heat exchanger temp.] - [Room temp.] > 10degC ▪ Heating operation [Indoor heat exchanger temp.] - [Room temp.] < - 10degC If the same operation is repeated 5 times, the compressor stops permanently.
---	---

<u>Forecast of Cause :</u> 1. Connector connection failure 2. Thermistor failure 3. Coil failure 4. 4-way valve failure 5. Controller PCB failure
--

Check Point 1 : Check connection of Connector
<ul style="list-style-type: none"> ▪ Check if connector is removed. ▪ Check erroneous connection. ▪ Check if thermistor cable is open. >> <u>Upon correcting the removed connector or mis-wiring, reset the power.</u>



Check Point 2 : Check each thermistor
<ul style="list-style-type: none"> ▪ Isn't it fallen off the holder? ▪ Is there a cable pinched? >> <u>Check characteristics of thermistor (Refer to Trouble shooting 5, 6),</u> <u>If defective, replace the thermistor</u>



Check Point 3 : Check the solenoid coil and 4-way valve
[Solenoid coil] <ul style="list-style-type: none"> ▪ Remove CN30 from PCB and check the resistance value of coil. Resistance value is 1.88kΩ ~ 2.29kΩ (at 20°C). >> <u>If it is Open or abnormal resistance value, replace Solenoid Coil.</u> [4-way valve] <ul style="list-style-type: none"> ▪ Check each piping temperature, and the location of the valve by the temperature difference. >> <u>If the value location is not proper, replace 4-way valve.</u>



Check Point 4 : Replace Controller PCB
▶ <u>If Check Point 1- 3 do not improve the symptom, replace Controller PCB.</u>

Trouble shooting 20 OUTDOOR UNIT Error Method: Discharge temperature error	Indicate or Display: Refer to error code table.
---	--

Detective Actuators: Outdoor unit Main PCB Discharge temperature thermistor	Detective details: ▪ "Protection stop by "discharge temperature $\geq 110\text{degC}$ during compressor operation"" generated 2 times within 24 hours.
--	--

Forecast of Cause :	1. 3-way valve not opened	2. EEV defective, strainer clogged
	3. Outdoor unit operation failure, foreign matter on heat exchanger	
	4. Discharge temperature thermistor failure	5. Insufficient refrigerant
	6. Main PCB failure	

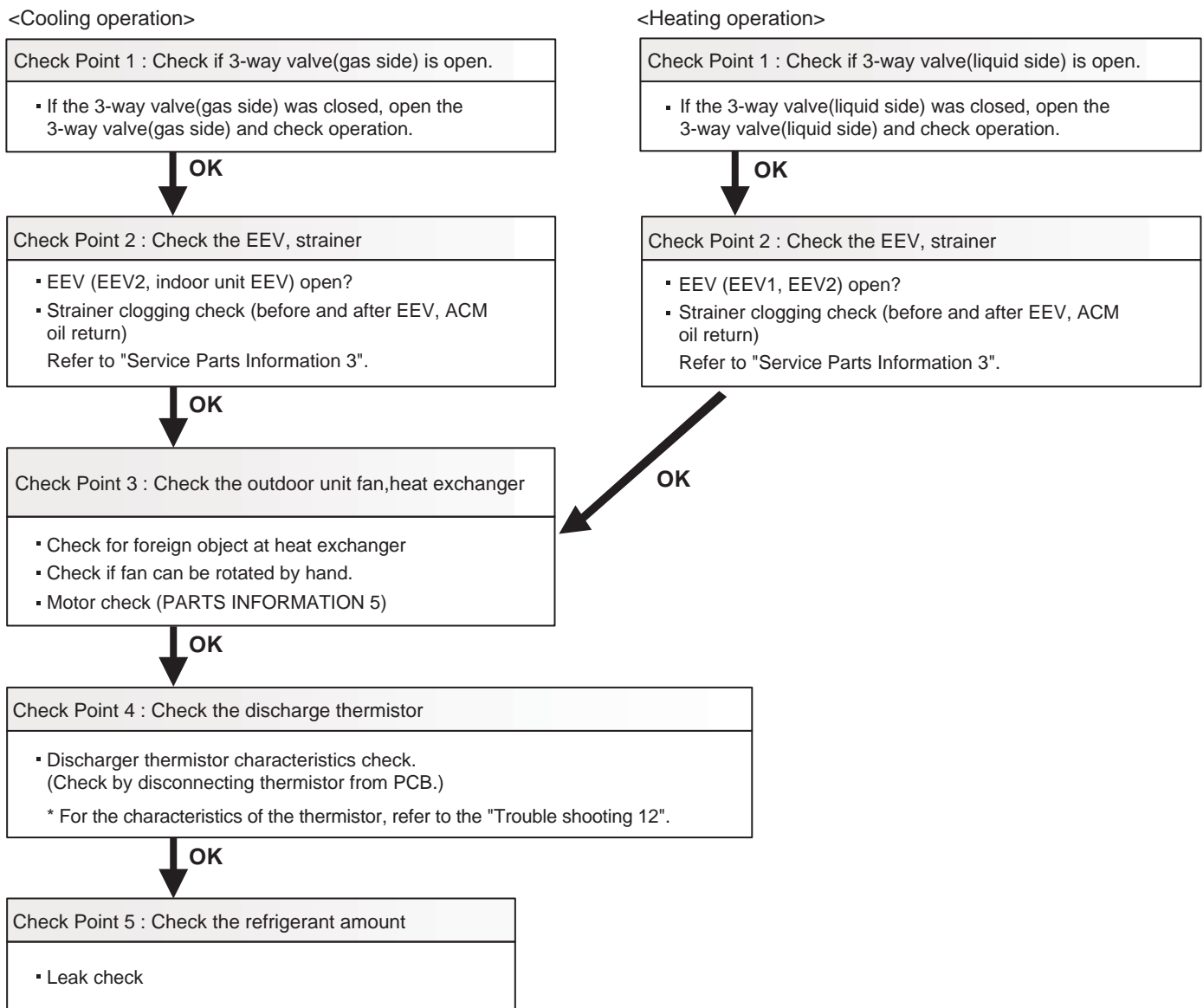

2-3 TROUBLE SHOOTING WITH NO ERROR CODE

Trouble shooting 21

Indoor Unit - No Power

Forecast of Cause:

1. Power supply failure
2. External cause
3. Electrical components defective

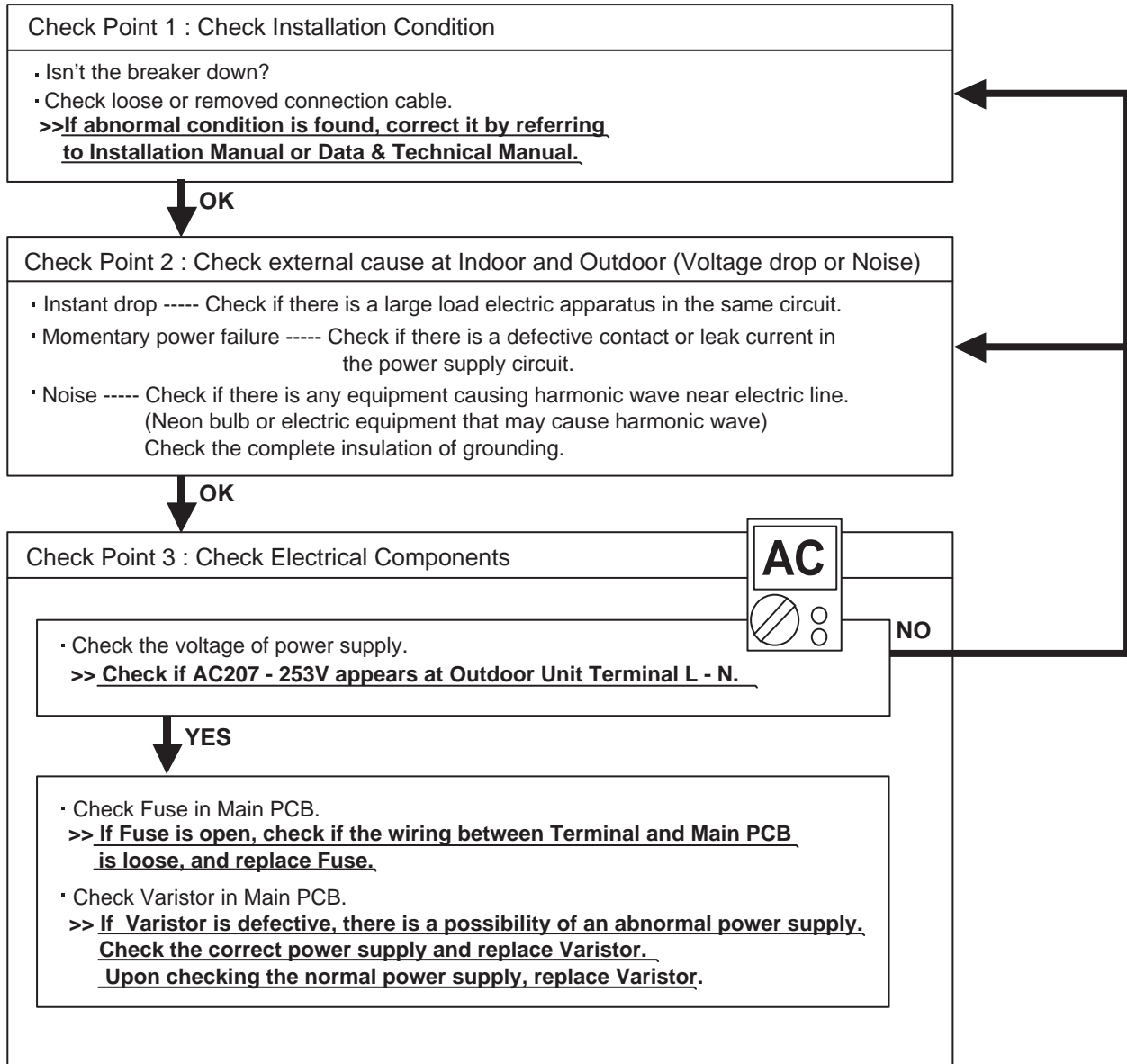

Trouble shooting 22

Outdoor Unit - No Power

Forecast of Cause:

1. Power supply failure
2. External cause
3. Electrical Components defective

Check Point 1 : Check Installation Condition

- Isn't the breaker down?
- Check loose or removed connection cable.
- >> **If abnormal condition is found, correct it by referring to Installation Manual or Data & Technical Manual.**

OK

Check Point 2 : Check external cause at Indoor and Outdoor (Voltage drop or Noise)

- Instant drop ----- Check if there is a large load electric apparatus in the same circuit.
- Momentary power failure ----- Check if there is a defective contact or leak current in the power supply circuit.
- Noise ----- Check if there is any equipment causing harmonic wave near electric line.
(Neon bulb or electric equipment that may cause harmonic wave)
Check the complete insulation of grounding.

OK

Check Point 3 : Check Electrical Components

- Check the voltage of power supply.
- >> **Check if AC207 - 253V appears at Outdoor Unit Terminal L - N.**

YES

- Check Fuse in Main PCB.
- >> **If Fuse is open, check if the wiring between Terminal and Main PCB is loose, and replace Fuse.**
- Check Varistor in Main PCB.
- >> **If Varistor is defective, there is a possibility of an abnormal power supply. Check the correct power supply and replace Varistor. Upon checking the normal power supply, replace Varistor.**

OK

► **If the symptom does not change by above Check 3, replace Main PCB.**



NO

Trouble shooting 23

No Operation (Power is ON)

Forecast of Cause:

1. Setting/ Connection failure
2. External cause
3. Electrical component defective

Check Point 1 : Check indoor and outdoor installation condition

- Indoor Unit - Check incorrect wiring between Indoor Unit - Remote Control.
Or, check if there is an open cable connection.
- Are these Indoor Unit, Outdoor Unit, and Remote Control suitable model numbers to connect?
>> If there is some abnormal condition, correct it by referring to Installation manual and Data & Technical Manual.

OK

Turn off Power and check/ correct followings.

- Is there loose or removed communication line of Indoor Unit and Outdoor Unit?

OK

Check Point 2 : Check external cause at Indoor and Outdoor (Voltage drop or Noise)

- Instant drop ----- Check if there is a large load electric apparatus in the same circuit.
- Momentary power failure ----- Check if there is a defective contact or leak current in the power supply circuit.
- Noise ----- Check if there is any equipment causing harmonic wave near electric line.
(Neon bulb or electric equipment that may cause harmonic wave)
Check the complete insulation of grounding.

OK

Check Point 3 : Check Electrical Components at Indoor and Outdoor

- Check Voltage at CN305 (terminal 1-3) of UTY-XCBXE(Communication kit).
(Power supply to Remote Control)
>> If it is DC13V, Remote Control is failure. (Controller PCB is normal) >> Replace Remote Control
>> If it is DC 0V, Controller PCB is failure. (Check Remote Control once again)
>> Check Indoor unit fan motor. (PARTS INFORMATION 4)
If it is normal, replace Controller PCB.
If it is abnormal, replace Indoor unit fan motor and Controller PCB.
>> If the symptom does not change by above Check 1, 2, 3, replace Main PCB of Outdoor unit.



Trouble shooting 24

No Cooling / No Heating

Forecast of Cause:

1. Indoor Unit error
2. Outdoor Unit error
3. Effect by surrounding environment
4. Connection pipe / Connection wire failure
5. Refrigeration cycle failure

Check Point 1 : Check Indoor unit

- Does Indoor unit Fan run on High fan?
- Is Air filter dirty?
- Is Heat exchanger clogged?
- Check if Energy save function is operated.



Check Point 2 : Check Outdoor unit operation

- Check if Outdoor unit is operating
- Check any objects that obstruct the air flow route.
- Check clogged Heat Exchanger.
- Is the Valve open?



Check Point 3 : Check Site condition

- Is capacity of Indoor unit fitted to room size?
- Any windows open? or direct sunlight ?



Check Point 4 : Check Indoor/ Outdoor installation condition

- Check connection pipe (specified pipe length & Pipe diameter?)
- Check any loose or removed communication line.
- >> If there is an abnormal condition, correct it by referring to Installation Manual or Data & Technical Manual.**



Check Point 5 : Check Refrigeration cycle

- Check if Strainer is clogged (Refer to the figure at right).
- Measure Gas Pressure and if there is a leakage, correct it.
- >> When recharging the refrigerant, make sure to perform vacuuming, and recharge the specified amount.**
- Check EEV (PARTS INFORMATION 3)
- Check Compressor (PARTS INFORMATION 1,2)

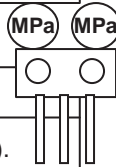

Attention

Strainer normally does not have temperature difference between inlet and outlet as shown in ①, but if there is a difference like shown in ②, there is a possibility of inside clogged. In this case, replace Strainer.

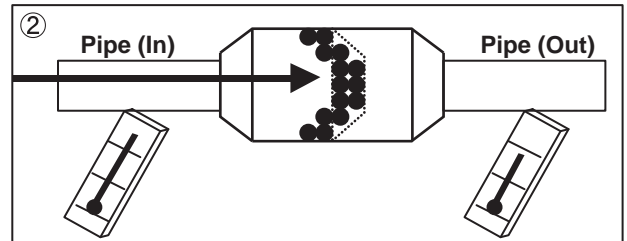
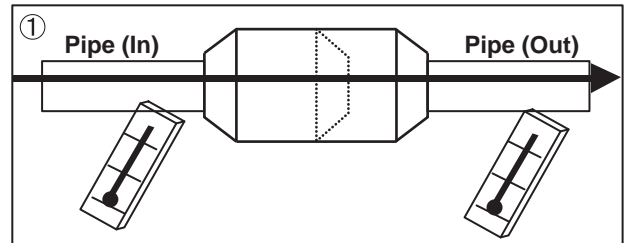

Trouble shooting 25

Abnormal Noise

Forecast of Cause :

1. Abnormal installation (Indoor/ Outdoor)
2. Fan failure (Indoor/ Outdoor)
3. Compressor failure (Outdoor)

Diagnosis method when abnormal noise is occurred

- Abnormal noise is coming from Indoor unit.
(Check and correct followings)

- Is Main unit installed in stable condition?
- Is the installation of air suction grille and front panel normal?

OK

- Is Fan broken or deformed?
- Is the screw of Fan loose?
- Is there any object which obstruct the Fan rotation?

- Abnormal noise is coming from Outdoor unit.
(Check and correct followings)

- Is Main unit installed in stable condition?
- Is Fan guard installed normally?

OK

- Is Fan broken or deformed?
- Is the screw of Fan loose?
- Is there any object which obstruct the Fan rotation?

OK

- Check if vibration noise by loose bolt or contact noise of piping is happening.

OK

- Is Compressor locked?
>> Check Compressor (PARTS INFORMATION 1,2)

Trouble shooting 26

Water Leaking

Forecast of Cause:

1. Erroneous installation
2. Drain hose failure

Diagnosis method when water leak occurs

- Is Main unit installed in stable condition?
- Is Main unit broken or deformed at the time of transportation or maintenance?

OK

- Is Drain hose connection loose?
- Is there a trap in Drain hose?
- Is Drain hose clogged?

OK

- Is Fan rotating?

Diagnosis method when water is spitting out.

- Is the filter clogged?

OK

- Check Gas pressure and correct it if there was a gas leak.

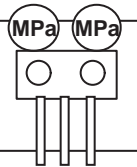

2-4 SERVICE PARTS INFORMATION

SERVICE PARTS INFORMATION 1

Compressor

Diagnosis method of Compressor (If Outdoor Unit LED displays Error, refer to Trouble shooting)

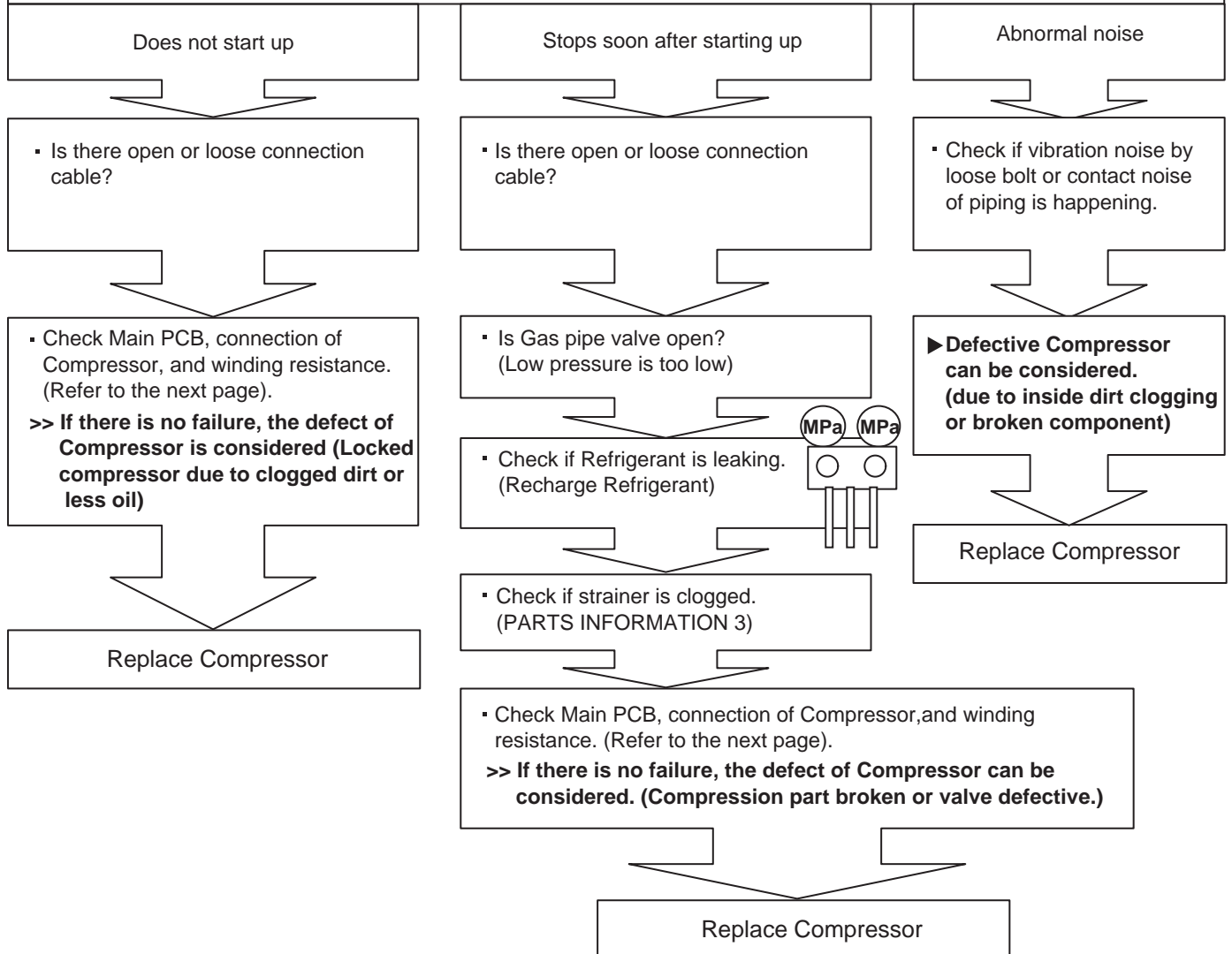

SERVICE PARTS INFORMATION 2

Inverter Compressor

Check Point 1 : Check Connection

- Check terminal connection of Compressor (loose or incorrect wiring)

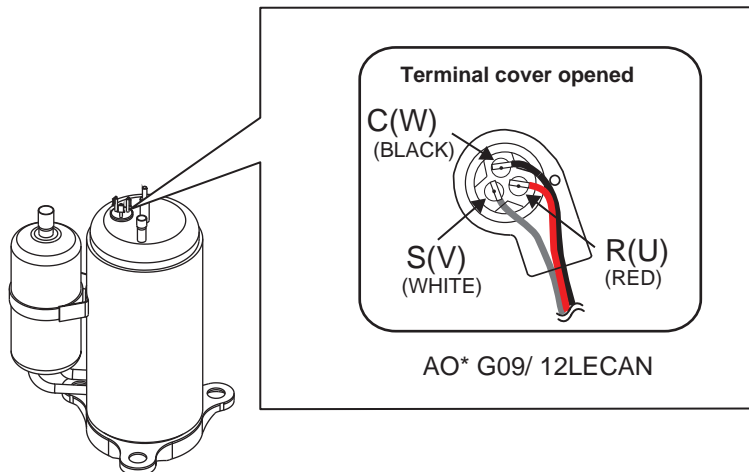

Check Point 2 : Check Winding Resistance

- Check winding resistance of each terminal

► **If the resistance value is 0Ω or infinite, replace Compressor.**

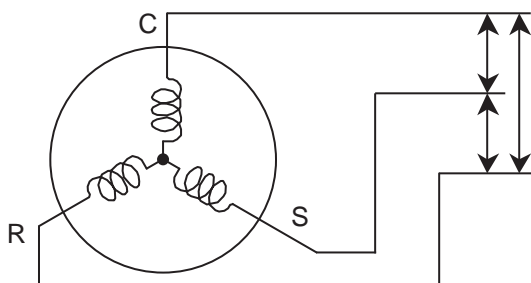

- AO* G09/ 12LECAN
Resistance Value :
0.7Ω at 20°C



Check Point 3 : Replace Main PCB

► **If the symptom does not change with above Check 1, 2, replace Main PCB.**

SERVICE PARTS INFORMATION 3

Outdoor unit Electronic Expansion Valve (EEV)

Check Point 1 : Check Connections

- Check connection of connector (CN40) (Loose connector or open cable)

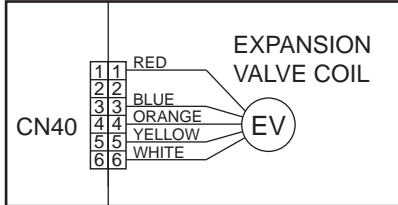

Check Point 2 : Check Coil of EEV

- Remove connector, check each winding resistance of Coil.

Read wire	Resistance value
White - Red	$46 \Omega \pm 4 \Omega$ at 20°C
Yellow - Red	
Orange - Red	
Blue - Red	

► **If Resistance value is abnormal, replace EEV.**

Check Point 3 : Check Voltage from Main PCB.

- Remove Connector and check Voltage (DC12V)

► **If it does not appear, replace Main PCB.**



Check Point 4 : Check Noise at start up

- Turn on Power and check operation noise.

► **If an abnormal noise does not show, replace Main PCB.**

Check Point 5 : Check Opening and Closing Operation of Valve

When Valve is closed, it has a temp. difference between Inlet and Outlet.

CLOSE
Example : Hot Gas

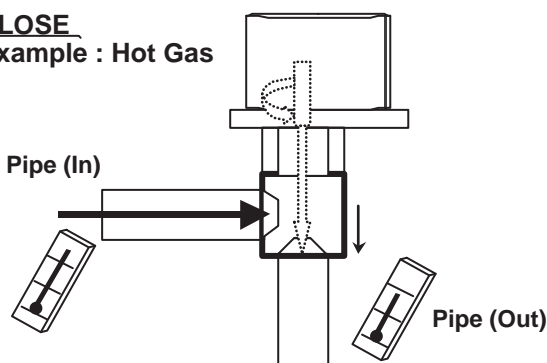

If it is open, it has no temp. difference between Inlet and Outlet.

OPEN
Example : Hot Gas

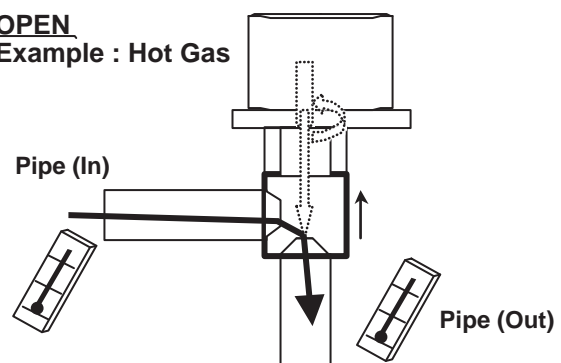

Check Point 6 : Check Strainer

Strainer normally does not have temperature difference between inlet and outlet as shown in ①, but if there is a difference as shown in ②, there is a possibility of inside clogged. In this case, replace Strainer.

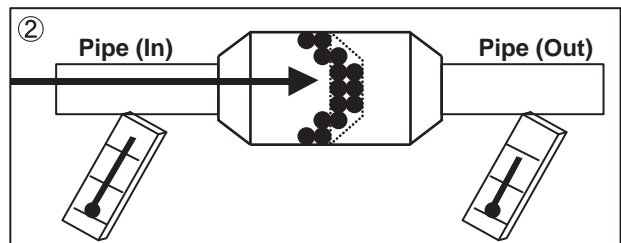
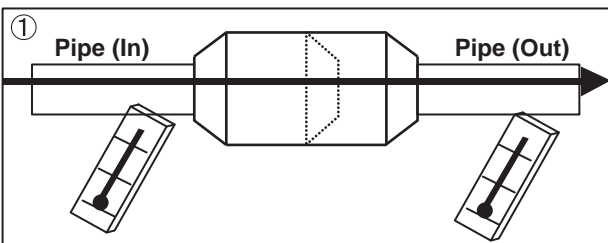

SERVICE PARTS INFORMATION 4

Indoor unit fan motor

Check Point 1 : Check rotation of Fan

- Rotate the fan by hand when operation is off.
(Check if fan is caught, dropped off or locked motor)
>>If Fan or Bearing is abnormal, replace it.

Check Point 2 : Check resistance of Indoor Fan Motor

- Refer to below. Circuit-test "Vm" and "GND" terminal.
(Vm: DC voltage, GND: Earth terminal)
>>If they are short-circuited (below 300 kΩ), replace Indoor fan motor and Controller PCB.

Pin number (wire color)	Terminal function (symbol)
1 (Blue)	Feed back (FG)
2 (Yellow)	Speed command (Vsp)
3 (White)	Control voltage (Vcc)
4 (Black)	Earth terminal (GND)
5	No function
6 (Red)	DC voltage (Vm)

SERVICE PARTS INFORMATION 5

Outdoor unit fan motor

Check Point 1 : Check rotation of Fan

- Rotate the fan by hand when operation is off.
(Check if fan is caught, dropped off or locked motor)
>>If Fan or Bearing is abnormal, replace it.

Check Point 2 : Check resistance of Outdoor Fan Motor

- Refer to below. Circuit-test "Vm" and "GND" terminal.
(Vm: DC voltage, GND: Earth terminal)
>>If they are short-circuited (below 300 kΩ), replace Outdoor fan motor and Main PCB.

Pin number (wire color)	Terminal function (symbol)
1 (Red)	DC voltage (Vm)
2	No function
3	No function
4 (Black)	Earth terminal (GND)
5 (White)	Control voltage (Vcc)
6 (Yellow)	Speed command (Vsp)
7 (Brown or Blue)	Feed back (FG)

WALL MOUNTED type INVERTER

3 . APPENDING DATA

3-1. FUNCTION SETTING

3-1-1 INDOOR UNIT

- Follow the instructions in the Local Setup Procedure, which is supplied with the remote control, in accordance with the installed condition.
After the power is turned on, perform the Function Setting on the remote control.
- The settings may be selected between the following two: Function Number or Setting Value.
- Settings will not be changed if invalid numbers or setting values are selected.

1-1. Setting the Filter Sign

The indoor unit has a sign to inform the user that it is time to clean the filter.

Select the time setting for the filter sign display interval in the table below according to the amount of dust or debris in the room.

If you do not wish the filter sign to be displayed, select the setting value for "No indication".

(◆ . . . Factory setting)

Setting Description	Function Number	Setting Value
Standard (400 hours)	11	00
Long interval (1000 hours)		01
Short interval (200 hours)		02
◆ No indication		03

1-2. Cooling Room Temperature Correction

Depending on the installed environment, the room temperature sensor may require a correction. The settings may be selected as shown in the table below.

(◆ . . . Factory setting)

Setting Description	Function Number	Setting Value
◆ Standard	30	00
Slightly lower control		01
Lower control		02
Warmer control		03

1-3. Heating Room Temperature Correction

Depending on the installed environment, the room temperature sensor may require a correction. The settings may be selected as shown in the table below.

(◆ . . . Factory setting)

Setting Description	Function Number	Setting Value
◆ Standard	31	00
Lower control		01
Slightly warmer control		02
Warmer control		03

1-4. Setting the Auto Restart

Enable or disable automatic system restart after a power outage.

(◆ . . . Factory setting)

Setting Description	Function Number	Setting Value
◆ Yes	40	00
No		01

1-5. Setting the Indoor room temperature sensor switching function (Only for Wired remote controller)

The following settings are needed when use the control by
Wired remote controller temperature sensor.

(◆ . . . Factory setting)

Setting Description	Function Number	Setting Value
◆ No	42	00
Yes		01

* If setting value is "00" : Room temperature is controlled by the indoor unit temperature sensor.

* If setting value is "01" : Room temperature is controlled by either indoor unit temperature sensor or remote controller unit sensor.

1-6. Setting the Remote controller signal code

Change the indoor unit Signal Code, depending on the remote controllers.

(◆ . . . Factory setting)

Setting Description	Function Number	Setting Value
◆ A	44	00
B		01
C		02
D		03

1-7. External input control

"Operation/Stop" mode or "Forced stop" mode can be elected.

(◆ . . . Factory setting)

Setting Description	Function Number	Setting Value
◆ Operation/Stop mode	46	00
(Setting forbidden)		01
Forced stop mode		02

1-8. Indoor unit fan control for energy saving (Only cooling mode)

Enable or disable indoor unit fan control when the outdoor unit is stopped.

(◆ . . . Factory setting)

Setting Description	Function Number	Setting Value
◆ No	49	00
Yes		01

* If setting value is "00" :

When the outdoor unit is stopped, the indoor unit fan operates following the setting on the remote controller continuously.

* If setting value is "01" :

When the outdoor unit is stopped, the indoor unit fan operates at very low speed intermittently.

3-1-2 Procedures to change the Function Setting for wireless RC

- This procedure changes to the function settings used to control the indoor unit according to the installation conditions. Incorrect settings can cause the indoor unit malfunction.
- After the power is turned on, perform the "FUNCTION SETTING" according to the installation conditions using the remote controller.
- Settings will not be changed if invalid numbers or setting values are selected.

Entering the Function Setting Mode

- While pressing the FAN button and SET TEMP.(▲) simultaneously, press the RESET button to enter the function setting mode.

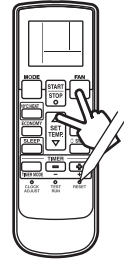

Selecting the Function Number and Setting Value

- (1) Press the MODE button, and proceed to Function Number and Setting Value.
(There is no necessity for setting remote control signal code. Because signal code is setting by Function Number and Setting Value.)



- (2) Press the SET TEMP. (▲) (▼) buttons to select the Function Number.
(Press the MODE button to switch between the left and right digits.)
- (3) Press the FAN button to proceed to Setting Value.
(Press the FAN button again to return to the Function Number selection.)
- (4) Press the SET TEMP. (▲) (▼) buttons to select the Setting Value.
(Press the MODE button to switch between the left and right digits.)

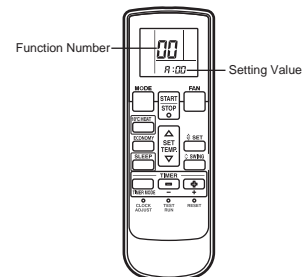

- (5) Press the TIMER MODE button. It makes a signal to indoor unit.
(Indoor unit recognize the setting.)
- (6) Press the START/STOP button. It makes a signal to indoor unit.
(Indoor unit run the setting.)

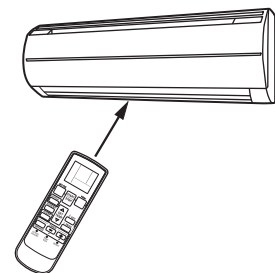

- (7) Press the RESET button to cancel the function setting mode.
- (8) After completing the FUNCTION SETTING, be sure to turn of the power and turn it on again.

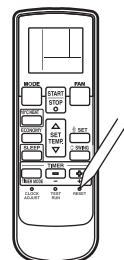

⚠ CAUTION

After turning off the power, wait 10 seconds or more before turning on it again.
The FUNCTION SETTING doesn't become effective if it doesn't do so.

Custom code setting for remote controller

- (1) Press the MODE button for more than 5 seconds.
- (2) Press the SET TEMP. (▲) (▼) buttons to change the signal code between $\overline{A} \rightarrow \overline{b} \rightarrow \overline{c} \rightarrow \overline{d}$.
Match the code on the display to the air conditioner signal code. (initially set to \overline{A})
- (3) Press the MODE button. (Return to normal display)

CAUTION

If you change the setting of Function Number and Setting Value after setting custom code in remote controller, please set custom code in remote controller again.

The remote control unit resets to signal code A when the batteries in the remote control unit are replaced. If you use a signal code other than signal code A, reset the signal code after replacing the batteries.

If you do not know the air conditioner signal code setting, try each of the signal codes ($\overline{A} \rightarrow \overline{b} \rightarrow \overline{c} \rightarrow \overline{d}$) until you find the code which operates the air conditioner.

3-2. Thermistor Resistance Values

3-2-1 INDOOR UNIT

Room temperature thermistor		
Temp (°C)	Resistance(k Ω)	Voltage(V)
-10.0	58.2	0.73
-5.0	44.0	0.93
0.0	33.6	1.15
5.0	25.9	1.39
10.0	20.2	1.66
15.0	15.8	1.94
20.0	12.5	2.22
25.0	10.0	2.50
30.0	8.0	2.77
35.0	6.5	3.03
40.0	5.3	3.27
45.0	4.3	3.48

Indoor heat exchanger thermistor		
Temp (°C)	Resistance(k Ω)	Voltage(V)
-5.0	233.2	0.88
0.0	176.0	1.10
5.0	134.2	1.36
10.0	103.3	1.63
15.0	80.3	1.92
20.0	62.9	2.21
25.0	49.7	2.51
30.0	39.6	2.79
35.0	31.7	3.06
40.0	25.6	3.30
45.0	20.8	3.53
50.0	17.1	3.73
55.0	14.1	3.90
60.0	11.6	4.05
65.0	9.7	4.19

3-2-2 OUTDOOR UNIT

Discharge thermistor		
Temp (°C)	Resistance(k Ω)	Voltage(V)
-30.0	1013.1	0.06
-25.0	729.1	0.09
-20.0	531.6	0.12
-15.0	392.3	0.16
-10.0	292.9	0.21
-5.0	221.1	0.28
0.0	168.6	0.36
5.0	129.8	0.46
10.0	100.9	0.57
15.0	79.1	0.71
20.0	62.5	0.86
25.0	49.8	1.03
30.0	40.0	1.23
35.0	32.4	1.43
40.0	26.3	1.65
45.0	21.6	1.88
50.0	17.8	2.11
55.0	14.8	2.34
60.0	12.3	2.57
65.0	10.3	2.79
70.0	8.7	3.00
75.0	7.4	3.19
80.0	6.3	3.37
85.0	5.4	3.54
90.0	4.6	3.69
95.0	4.0	3.83
100.0	3.4	3.96
105.0	3.0	4.07
110.0	2.6	4.17
115.0	2.3	4.26
120.0	2.0	4.33

Outdoor heat exchanger thermistor		
Temp (°C)	Resistance(k Ω)	Voltage(V)
-30.0	95.6	0.24
-25.0	68.9	0.32
-20.0	50.3	0.43
-15.0	37.2	0.57
-10.0	27.8	0.73
-5.0	21.0	0.92
0.0	16.1	1.14
5.0	12.4	1.39
10.0	9.6	1.65
15.0	7.6	1.93
20.0	6.0	2.21
25.0	4.8	2.49
30.0	3.8	2.77
35.0	3.1	3.02
40.0	2.5	3.26
45.0	2.1	3.48
50.0	1.7	3.67
55.0	1.4	3.85
60.0	1.2	4.00
65.0	1.0	4.13
70.0	0.8	4.25
75.0	0.7	4.35
80.0	0.6	4.43

Outdoor temperature thermistor		
Temp (°C)	Resistance(k Ω)	Voltage(V)
-30.0	224.3	0.73
-25.0	159.7	0.97
-20.0	115.2	1.25
-15.0	84.2	1.56
-10.0	62.3	1.90
-5.0	46.6	2.26
0.0	35.2	2.61
5.0	26.9	2.94
10.0	20.7	3.24
15.0	16.1	3.52
20.0	12.6	3.76
25.0	10.0	3.96
30.0	8.0	4.14
35.0	6.4	4.28
40.0	5.2	4.40
45.0	4.2	4.50
50.0	3.5	4.59
55.0	2.8	4.65
60.0	2.4	4.71
65.0	2.0	4.76
70.0	1.6	4.79
75.0	1.4	4.83
80.0	1.2	4.85



FUJITSU GENERAL LIMITED

1116,Suenaga,Takatsu-ku,Kawasaki 213-8502,Japan